

## LED Module

# LT-S562F LT-S282F



### Features & Benefits

- Easy connection with re-workable poke-in connector
- Fit better to replace conventional T5, T8 fixture with narrow width
- Full Certifications

### Applications

#### Indoor Lighting:

- Office / Retail/ Living space
- Area Panels, Troffer and Linear Pendants
- Channel and Cove lighting



## Table of Contents

1.	Product Code Information	-----	3
2.	Characteristics	-----	4
3.	Structure and Assembly	-----	8
4.	Certification and Declaration	-----	12
5.	Label Structure	-----	13
6.	Packing Structure	-----	15
7.	Precautions in Handling & Use	-----	16



## 1. Product Code Information

### a) S562F

Nominal CCT (K)		Product Code
3000	Front CNT	SI-B8V14156SWW
3500		SI-B8U14156SWW
4000		SI-B8T14156SWW
5000		SI-B8R14156SWW
3000	Rear CNT	SI-B8V14256SWW
3500		SI-B8U14256SWW
4000		SI-B8T14256SWW
5000		SI-B8R14256SWW

### b) S282F

Nominal CCT (K)		Product Code
3000	Front CNT	SI-B8V07128SWW
3500		SI-B8U07128SWW
4000		SI-B8T07128SWW
5000		SI-B8R07128SWW
3000	Rear CNT	SI-B8V07228SWW
3500		SI-B8U07228SWW
4000		SI-B8T07228SWW
5000		SI-B8R07228SWW



## 2. Characteristics

Item	Rating	Unit	Remark
Rated Lifetime	>50,000	hour	L70B50
Ingress Protection (IP)	no rating	-	
Ambient / Operating Temperature ( $t_{amb}$ )	-20 ~ +50	°C	
Storage Temperature	-30 ~ +80	°C	

### a) S562F

Item	Nom. CCT (K)	Rating			Unit	Remark	
		Min	Typ.	Max			
Luminous Flux ( $\Phi_v$ )	3000	1960	2180	2400	lm	$I_f = 800 \text{ mA}$ $t_p = 50 \text{ }^\circ\text{C}$	
	3500	1990	2210	2430			
	4000	2030	2250	2480			
	5000	2060	2290	2520			
Luminous Efficacy	3000	140	155	171	lm/W		
	3500	141	157	173			
	4000	144	160	176			
	5000	147	163	179			
CCT	3000	2941	3023	3113	K		
	3500	3320	3430	3552			
	4000	3788	3928	4083			
	5000	4809	4993	5171			
Color Consistency (initial)		-	3	-	MacAdam step		
Color Rendering Index (Ra)		80	82	-	-		
Operating Current ( $I_f$ )		-	800	1440	mA		-
Operating Voltage ( $V_f$ )		16.4	17.6	18.8	Vdc		$I_f = 800 \text{ mA}$ $t_p = 50 \text{ }^\circ\text{C}$
Power Consumption		13.1	14.1	15.1	W		

#### Notes:

- 1)  $t_p$ : temperature at which performance is specified; measured at "Tc point".
- 2) Samsung maintains a measurement tolerance of: Luminous flux:  $\pm 7 \%$ , CRI:  $\pm 3.0$ , Voltage:  $\pm 0.3 \text{ V}$ , Power Consumption:  $\pm 0.3 \text{ W}$
- 3) Max 4 kV for ESD(Direct contact)



## b) S282F

Item	Nom. CCT (K)	Rating			Unit	Remark
		Min	Typ.	Max		
Luminous Flux ( $\Phi_v$ )	3000	970	1080	1190	lm	If = 800 mA tp = 50 °C
	3500	980	1090	1200		
	4000	1020	1120	1230		
	5000	1020	1140	1250		
Luminous Efficacy	3000	140	155	171	lm/W	
	3500	141	157	173		
	4000	144	160	176		
	5000	147	163	179		
CCT	3000	2941	3023	3113	K	
	3500	3320	3430	3552		
	4000	3788	3928	4083		
	5000	4809	4993	5171		
Color Consistency (initial)		-	3	-	MacAdam step	
Color Rendering Index (Ra)		80	82	-	-	
Operating Current (If)		-	800	1440	mA	-
Operating Voltage (Vf)		8.2	8.8	9.4	Vdc	If = 800 mA tp = 50 °C
Power Consumption		6.5	7.0	7.5	W	

**Notes:**

- 4)  $t_p$ : temperature at which performance is specified; measured at "Tc point".
- 5) Samsung maintains a measurement tolerance of: Luminous flux:  $\pm 7\%$ , CRI:  $\pm 3.0$ , Voltage:  $\pm 0.3$  V, Power Consumption:  $\pm 0.3$ W
- 6) Max 4 kV for ESD(Direct contact)



Item	Nominal*	Life**	Max***	Unit
Temperature	50 ( $t_p$ )	80( $t_{p,50}$ )	90( $t_c$ )	°C

**Notes:**

- \* Temperature used to specify performance of the module ( $t_p$ ).
- \*\* Rated maximum performance temperature at which lifetime is specified ( $t_{p,50}$ ).
- \*\*\* Rated maximum temperature, highest permissible temperature to avoid safety risk ( $t_c$ ).

All temperatures are measured at the designated “Tc point” as indicated on the module.



### 3. Structure and Assembly

#### a) Appearance

##### S562F

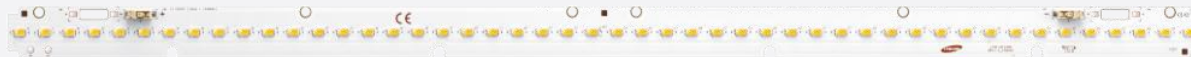

##### S282F



#### b) Dimension

##### S562F

Dimension	Specification	Tolerance	Unit
Module Length	559.7	$\pm 0.3$	mm
Module Width	23.8	$\pm 0.2$	mm
Module Height	Front : 5.8 Rear : 7.4	$\pm 0.3$	mm
PCB Thickness	1.6	$\pm 0.16$	mm
Module Weight	76.0	$\pm 3.8$	g

#### - Front Connector Module

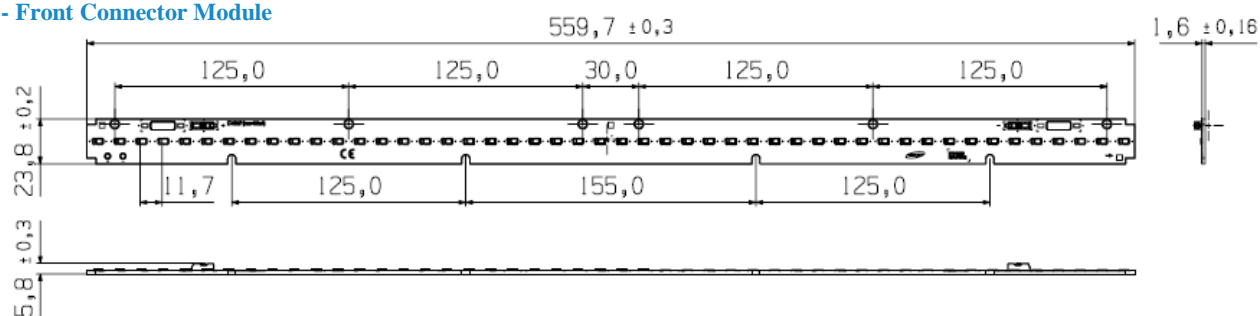

#### - Rear Connector Module

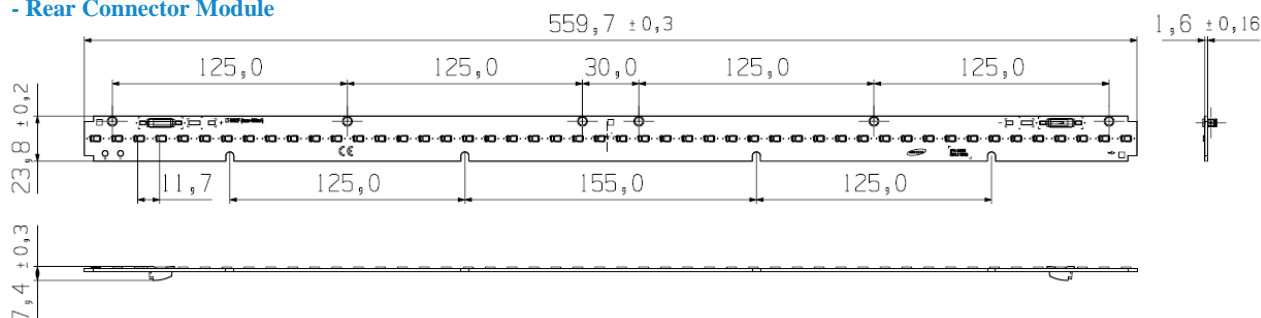

## S282F

Dimension	Specification	Tolerance	Unit
Module Length	279.7	$\pm 0.3$	mm
Module Width	23.8	$\pm 0.2$	mm
Module Height	Front : 5.8 Rear : 7.4	$\pm 0.3$	mm
PCB Thickness	1.6	$\pm 0.16$	mm
Module Weight	35	$\pm 1.8$	g

## - Front Connector Module

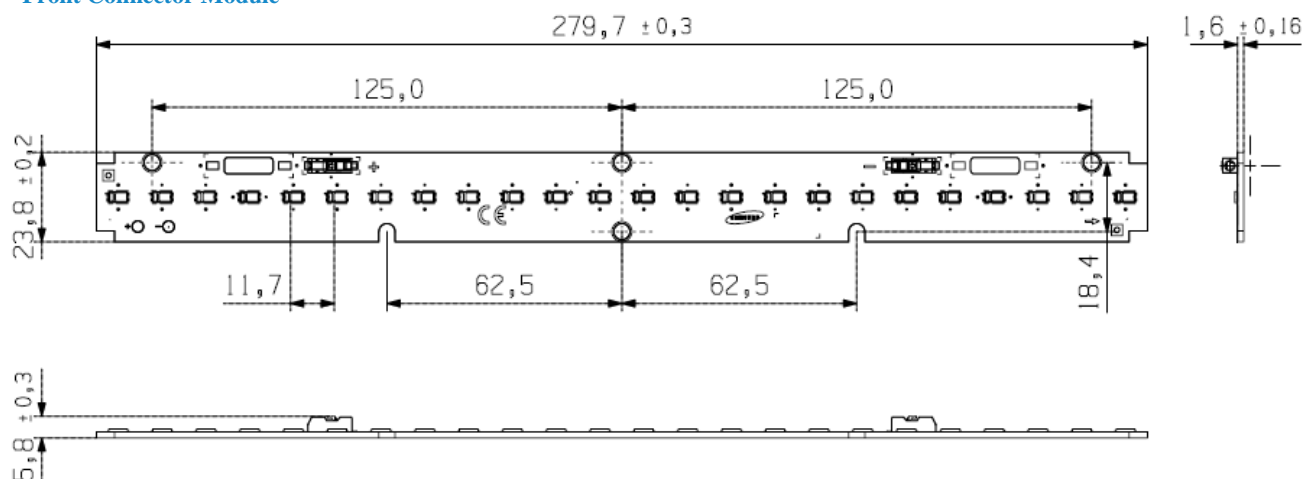

## - Rear Connector Module

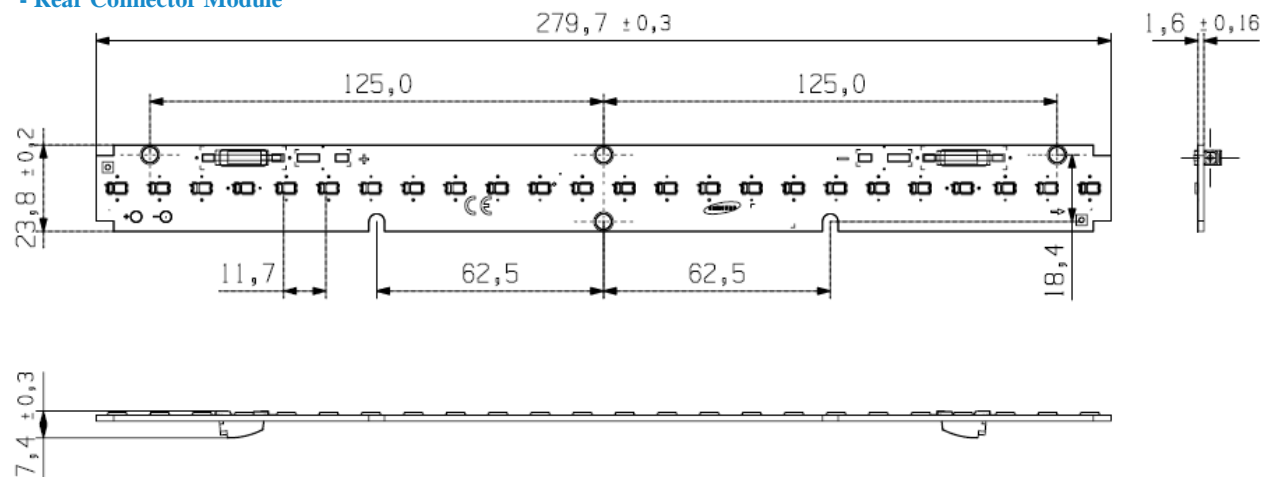



### c) Assembly

Connectors on the board are provided for easy wiring with the LED driver and between modules

[Front connector]



[Rear connector]



### d) Structure

Item	Specification
LED	LM561B+ Middle Power LED
PCB	CEM-3; Material: copper, solder mask, epoxy
Connector	Reworkable poke-in connector type
Wire	24~18 AWG; terminal strip length of 7.5~8.5 mm

### e) Light Distribution

Polar Intensity Diagram: Beam Angle  $115 \pm 5^\circ$

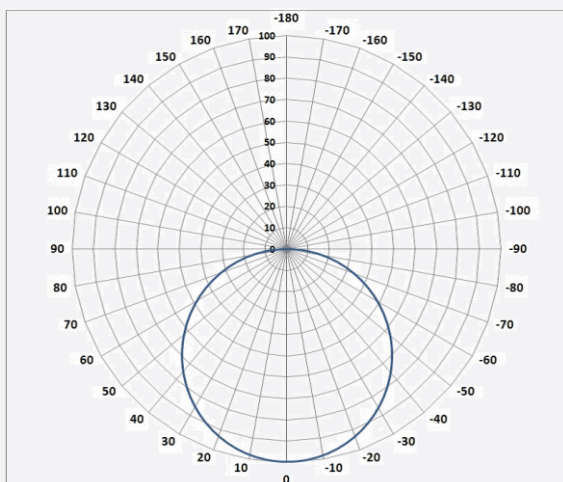

### f) Thermal Management

Performance temperatures are measured on “Tc point” as indicated on the module.

[S562F]

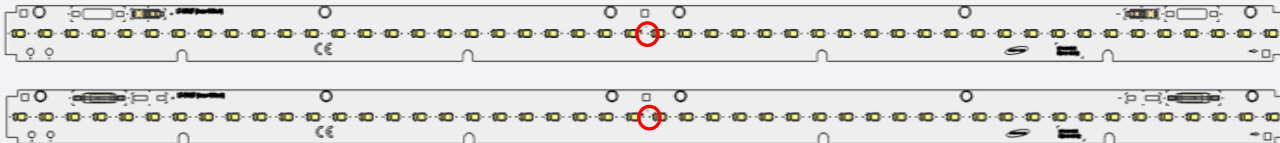

[S282F]

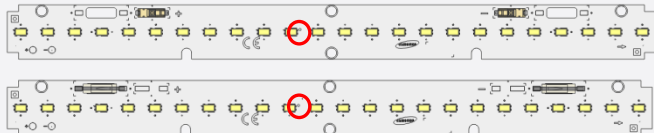

### g) Schematic Circuit

S562F : 6s x 8p

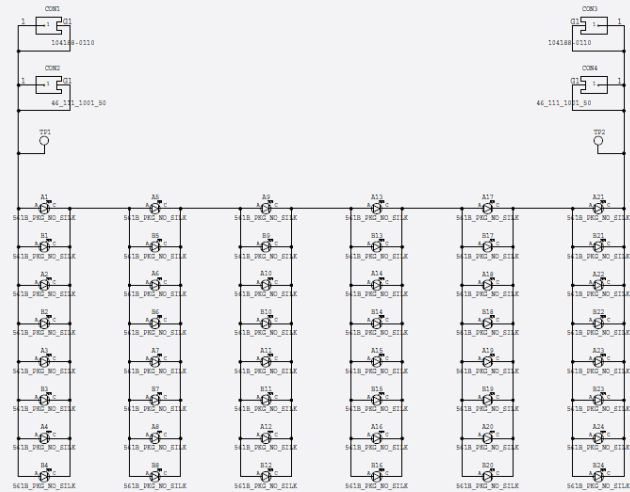

S282F : 3s x 8p

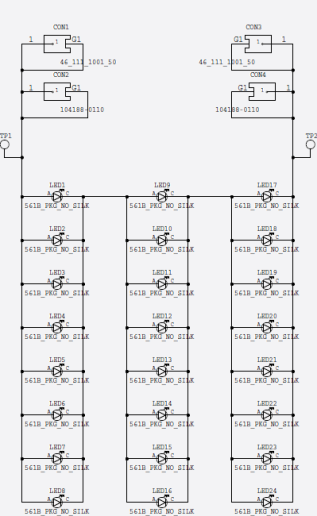

#### 4. Certification and Declaration

Item	Compliant to	Remark
Test & Certification	CE	IEC / EN 62031, IEC / EN 62471
	ENEC	IEC / EN 62031, IEC / EN 62471
	VDE	IEC / EN 62031, IEC / EN 62471
	UL	UL 8750
	cUL	CSA250.13
	Photo biological Safety(LM561B+ LED)	IEC / EN 62471
Declaration	RoHS	Hazardous Substance & Material
	REACH	Hazardous Substance & Material



## 5. Label Structure

### a) Module Label

#### A. Printing Label

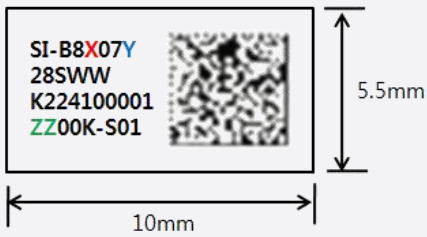

#### B. Information of Barcode

Ex) SI-B8X07Y28SWW K224100001ZZ00K-S01  
 ① ② ③ ④ ⑤ ⑥ ⑦ ⑧

① Model code : : SI-B8X07Y28SWW

**X** : V(3000K), U(3500K), T(4000K), R(5000K)

**Y** : 1(Front connector), 2(Rear connector)

② Space: Space

③ SMT date : K224 (2010-February-24th)

A(2000), B(2001) ······ J(2009), K(2010), L(2011), ······ (year)

1(January), ······ 9(September), A(October), B(November), C(December)(month)

01, 02, ······ 31th (date)

④ SMT Line No. : 1~9, A(10), B(11), C(12), D(13), E(14), F(15)

⑤ Serial No. : 00001~99999, (Setting "00001" every working day)

⑥ Color temperature : ZZ00K

ZZ : 30, 35, 40, 50

⑦ LED Maker : -S (Samsung)

⑧ Group No. : 01 (Binning group)

C. QR CODE Information

[LT-S282F]

Model CODE	SI-B8X07Y28SWW
QR CODE Information	SI-B8X07Y28SWW K224100001ZZ00K-S01
Printed CODE Information	SI-B8X07Y28SWW K224100001ZZ00K-S01

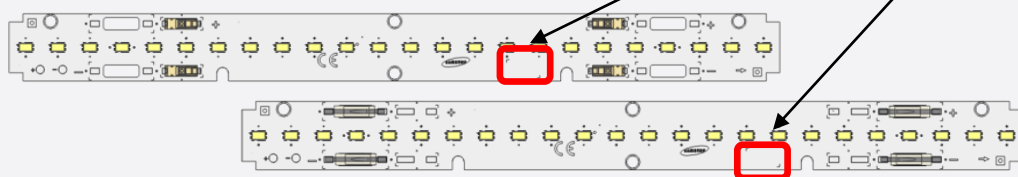
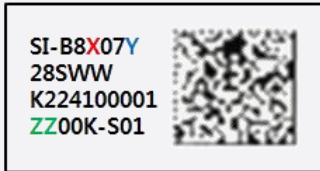

[LT-S562F]

Model CODE	SI-B8X14Y56SWW
QR CODE Information	SI-B8X14Y56SWW K224100001ZZ00K-S01
Printed CODE Information	SI-B8X14Y56SWW K224100001ZZ00K-S01

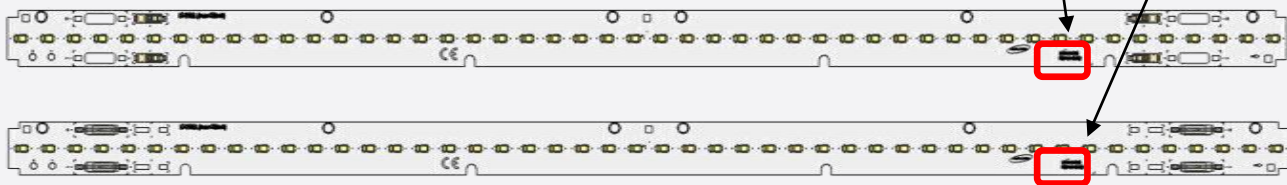
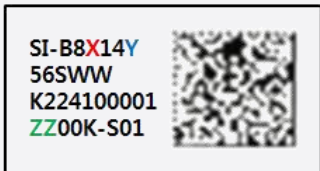

## b) TRAY &amp; MBB bag LABEL



① Model code : : SI-B8X07Y28SWW

② LOT : 20140105-E0001

Packing Date(8 digit) → 20140105

Production Site(1 digit) → PyeongTaek Seoil(E), TianJIn Seoil(D), SLED(B)

Serial no(4 digit) → 0001~9999, A111~A999

③ QTY : Quantity of Packaged Bar (5 Digit)

④ W/W : Production Year(2 digit) + Production Week(2 digit)

⑤ Issue date of Label : 12:year/01:month/30:day

**C) Box Label**

- 100mm x 50mm



The lot number is composed of the following characters:

- ① Product code
- ② Lot ID
- ③ Place of origin
- ④ Quantity
- ⑤ Describe production week
- ⑥ Date of Issue
- ⑦ Binning Group

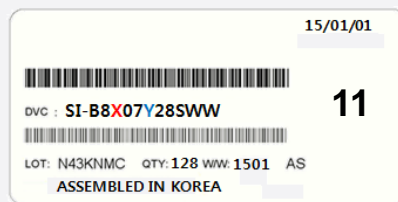
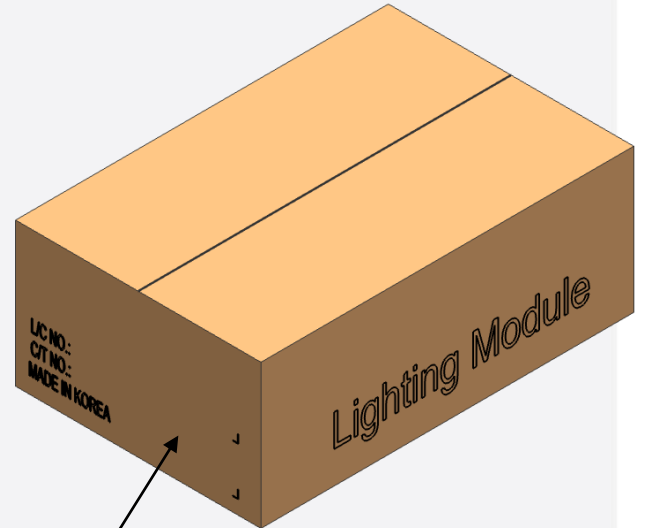

**6. Packing Structure**

ARTICLE	TRAY	BOX	PALLET	REMARK	
Quantity	28 ea	224 ea	3072 ea	S562	Front Connector
			5376 ea	S282	
	16 ea	128 ea	2048 ea	S562	Rear Connector
			3072 ea	S282	



## 7. Precautions in Handling & Use

A. The LED Lighting Modules for white light are devices which are materialized by combining white LEDs.

The color of white light can differ a little unusually to diffuser plate(sign-board panel).

Also when the LEDs are illuminating, operating current should be decided after considering the ambient maximum temperature.

### B. Handling

To prevent the LED Lighting Modules from making any defectives, please handle the LED Lighting Modules with care as follows.

- (1) Don't drop the unit and don't give the unit any shocks.
- (2) Don't bend the PCB and don't touch the LED Resin.
- (3) Don't storage the Module in a dusty place or room.
- (4) Don't take the product apart.
- (5) Don't touch the LED and also PCB and other circuit parts of Module with your naked fingers or sharpness things.
- (6) Take care so that do not pull wire with hand in case of carries or moves LED Lighting Modules.

### C. Cleaning

The LED Lighting Modules should not be used in any type of fluid such as water, oil, organic solvent, etc.

It is recommended that IPA (Isopropyl Alcohol) be used as a solvent for cleaning the LED Lighting Modules.

When using other solvents, it should be confirmed beforehand whether the solvents will dissolve the package and the resin or not. Freon solvents should not be used to clean the LEDs because of worldwide regulations. Do not clean the LED Lighting Modules by the ultrasonic.

Before cleaning, a pre-test should be done to confirm whether any damage to the LED Lighting Modules will occur.

### D. Static Electricity

Static electricity or surge voltage damages the LED Lighting Modules. Please keep the working process anti-static electricity condition to prevent the Lighting from destroying, as following.

- (1) Anyone who handles the unit should be well grounded.(earth ring or anti-static glove)
- (2) Anyone who handles the unit should wear anti-electrostatic working clothes.
- (3) All kinds of device and instruments, such as working table, measuring instruments and assembly jigs in your production lines should be well grounded.

### E. Storage

The LED Lighting Modules must be stored to insert a package of a moisture absorbent material(silica gel) in a box.

### F. Others

If over voltage which exceeds the absolute maximum rating is applied to LED Lighting Modules.

It will cause damage Circuits(that LED is included) and result in destruction.

Do not directly look into lighted LED with naked eyes.

Please use this product within 5 months, which is kept in its original packaging unopened when stocked





# Legal and additional information.

## [About Samsung Electronics Co., Ltd.](#)

Samsung Electronics Co., Ltd. is a global leader in technology, opening new possibilities for people everywhere. Through relentless innovation and discovery, we are transforming the worlds of TVs, smartphones, tablets, PCs, cameras, home appliances, printers, LTE systems, medical devices, semiconductors and LED solutions. We employ 286,000 people across 80 countries with annual sales of US\$216.7 billion. To discover more, please visit [www.samsungled.com](http://www.samsungled.com).

Copyright © 2015 Samsung Electronics Co., Ltd. All rights reserved.  
Samsung is a registered trademark of Samsung Electronics Co., Ltd.  
Specifications and designs are subject to change without notice. Non-metric weights and measurements are approximate. All data were deemed correct at time of creation. Samsung is not liable for errors or omissions. All brand, product, service names and logos are trademarks and/or registered trademarks of their respective owners and are hereby recognized and acknowledged.

Samsung Electronics Co., Ltd.  
95, Samsung 2-ro  
Giheung-gu  
Yongin-si, Gyeonggi-do, 446-711  
KOREA

[www.samsungled.com](http://www.samsungled.com)



单击下面可查看定价，库存，交付和生命周期等信息

[>>Samsung Semiconductor\(三星半导体\)](#)