

General

- Chip size from 0603 to 2512
- Resistance value from 2 mΩ to 700mΩ
- High power rating
- Low inductance 0.5nH to 5nH
- Low TCR
- Compatible with RoHS & Halogen free

Application

- Switching model power supply
- Battery pack
- Notebook, personal computer
- Test Instrument
- Power Amplifier

Electrical Specifications

Type	Power Rating at 70°C(W)	Resistance Range (mΩ)	TCR (ppm/°C)	Resistance tolerance	Operating Temperature
0603	0.5	5~9	±75	±1%(F)	-55°C~+155°C
		10~100	±50	±0.5%(D),±1%(F)	
0805	0.75	3	±75	±1%(F),±1.5%(E),±2%(G)	
		4~500	±50	±0.5%(D),±1%(F)	
1206	0.5 1.0	3	±75	±1%(F),±1.5%(E),±2%(G)	
		4~700	±50	±0.5%(D),±1%(F)	
2010	1.5	2~3	±100	±1%(F),±1.5%(E),±2%(G)	
		4~9	±100	±1%(F)	
		10~700	±50	±0.5%(D),±1%(F)	
2512	2.0	2~3	±75	±1%(F),±1.5%(E),±2%(G)	
		4~700	±50	±0.5%(D),±1%(F)	

Part Number Information

SMD 25 A 2 F R003 T
 【1】 【2】 【3】 【4】 【5】 【6】 【7】

- 【1】 Series Name: SART Metal Foil Type
- 【2】 Chip size: 06:0603 08: 0805 12: 1206 20: 2010 25: 2512
- 【3】 Material Code: A:Alloy
- 【4】 Power Code:A: 0.5W B: 1.5W C: 0.75W 1: 1W 2: 2W
- 【5】 Resistance Tolerance: F: $\pm 1\%$ D: $\pm 0.5\%$ E: $\pm 1.5\%$ G: $\pm 2\%$
- 【6】 Resistance Code: R003 = 3 m Ω R050 = 50 m Ω R200 = 200 m Ω
- 【7】 Packaging Code: T:Tape& Reel B: Bulk Pack

Dimensions

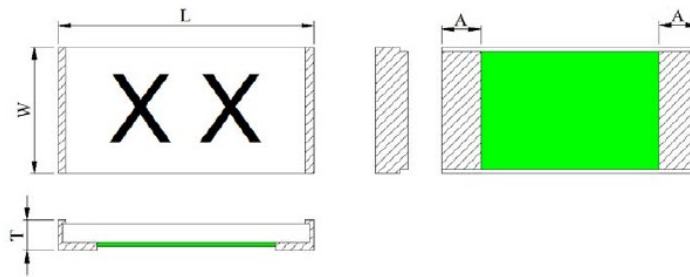

Type	Resistance (m Ω)	L (mm)	W (mm)	T (mm)	A (mm)
0603	5	1.70 \pm 0.20	0.90 \pm 0.20	0.65 \pm 0.20	0.50 \pm 0.20
	6~100	1.70 \pm 0.20	0.90 \pm 0.20	0.65 \pm 0.20	0.40 \pm 0.20

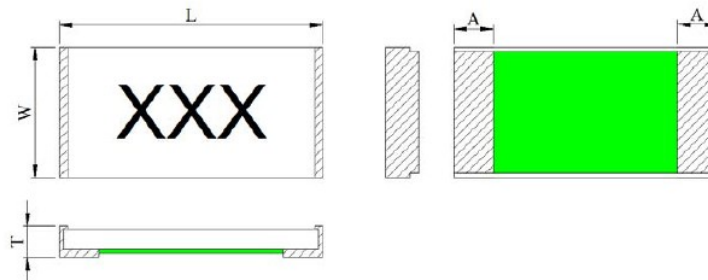

Type	Resistance (m Ω)	L (mm)	W (mm)	T (mm)	A (mm)
0805	3	2.10 \pm 0.20	1.35 \pm 0.20	0.65 \pm 0.20	0.65 \pm 0.20
	4~500	2.10 \pm 0.20	1.35 \pm 0.20	0.65 \pm 0.20	0.50 \pm 0.20

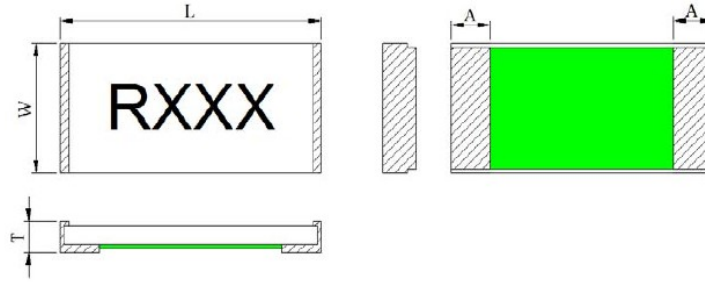

Type	Resistance (mΩ)	L (mm)	W (mm)	T (mm)	A (mm)
1206	3	3.30±0.20	1.70±0.20	0.65±0.20	1.20±0.30
	4~700	3.30±0.20	1.70±0.20	0.65±0.20	0.68±0.30
2010	2~3	5.10±0.20	2.60±0.20	0.65±0.20	2.10±0.30
	4~700	5.10±0.20	2.60±0.20	0.65±0.20	0.70±0.30
2512	2	6.40±0.30	3.20±0.30	0.65±0.20	2.80±0.30
	3	6.40±0.30	3.20±0.30	0.65±0.20	2.60±0.30
	4~700	6.40±0.30	3.20±0.30	0.65±0.20	1.05±0.30

Recommended Land Patterns

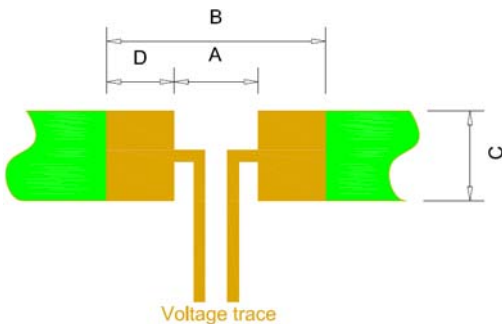

Type	Resistance (mΩ)	A (mm)	B (mm)	C (mm)	D (mm)
0603	5	0.50	3.20	0.92	1.35
	6~100	0.60	3.20	0.92	1.30
0805	3	0.50	3.60	1.44	1.55
	4~500	0.80	3.60	1.44	1.40
1206	3	0.60	4.80	1.84	2.10
	4~700	1.20	4.80	1.84	1.80
2010	2~3	0.70	8.00	2.88	3.65
	4~700	2.70	8.00	2.88	2.65
2512	2	0.60	9.30	3.57	4.35
	3	0.90	9.30	3.57	4.20
	4~700	3.10	9.30	3.57	3.10

Materials

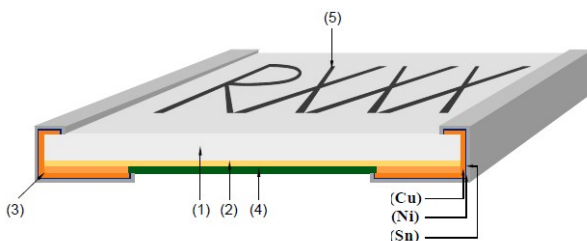

No.	Materials	No.	Materials
1	Ceramic	4	Coating
2	MnCu-Alloy	5	Marking
3	Terminal electrode	/	/

Temperature Derating Curve

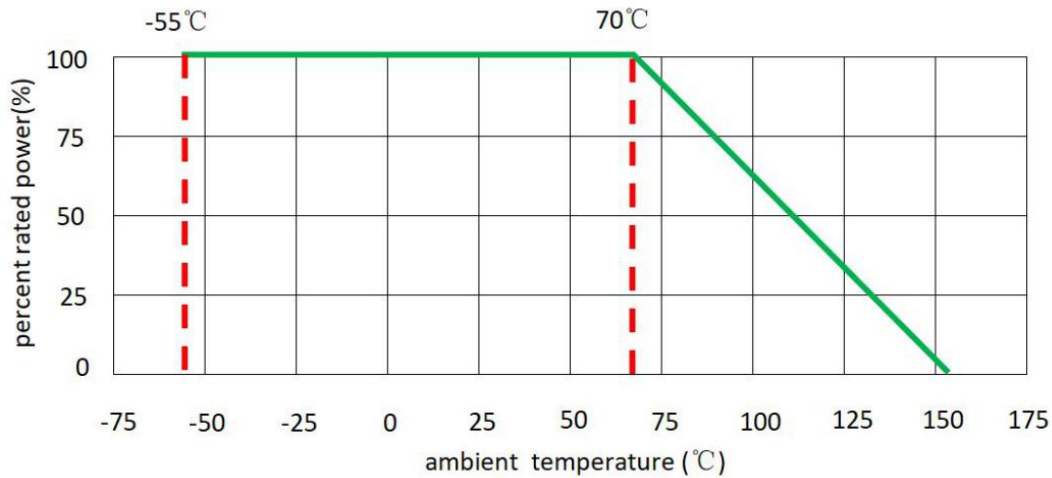

Recommended Solder Curve

1. Infrared Reflow

- Temperature: 260°C
- Time: 5sec Max.
- Recommend Reflow profile:

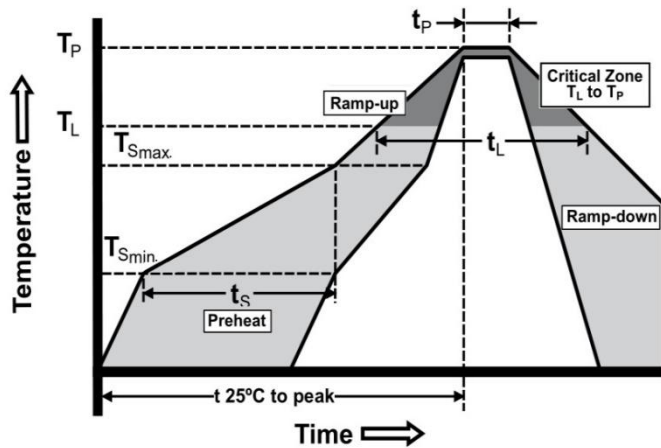

Profile Feature	Pb-Free Assembly
Average Ramp-up Rate (T _{Smax} to T _p)	3°C/sec Max.
Preheat Temperature Min. (T _{Smin}) Temperature Max. (T _{Smax}) Time (T _{Smin} to T _{Smax})	150°C 200°C 60sec~120sec
Peak Temperature (T _p)	260°C
Time within 5°C of actual Peak Temperature (T _p)	5sec
Melting tin time (T _L)	20sec~30sec
Ramp-down Rate	6°C/sec Max.
Time 25°C to peak Temperature	8min Max.

2. Wave soldering

- Reservoir Temperature: 260°C
- Time in Reservoir: 10sec Max.

3. Hand Soldering

- Temperature: 350°C
- Time: 5sec Max.

Product Characteristics

Item	Test condition / Methods	Performance	Standard
Short Time Overload	0603/0805/1206/2512 $R \leq 10m\Omega$: $P = 5*Pr$; $T = 25^{\circ}C \pm 2^{\circ}C$, $t = 5sec$ Rest specifications: $P = 2.5*Pr$; $T = 25^{\circ}C \pm 2^{\circ}C$, $t = 5sec$	$ \Delta R \leq \pm(1\% + 0.5 m\Omega)$	IEC 60115-1 4.13
Temperature Coefficient of Resistance (TCR)	$TCR = (R - R_0) / R_0 (T_2 - T_1) * 10^6$ T1 T2 Test temperature: $+25^{\circ}C \sim +125^{\circ}C$	Refer to SART Spec	IEC 60115-1 4.8
Thermal Shock	$-55^{\circ}C (30min) / +155^{\circ}C (30min)$, 100 cycles	$ \Delta R \leq \pm(1\% + 0.5 m\Omega)$	IEC 60115-1 4.19
Resistance to Solder Heat	$275^{\circ}C \pm 5^{\circ}C$, 20sec \pm 1sec	$ \Delta R \leq \pm(1\% + 0.5m\Omega)$	IEC 60115-1 4.18
Solderability	$245^{\circ}C \pm 5^{\circ}C$, 3.0sec \pm 0.5sec	95% coverage Min.	IEC 60115-1 4.17
Load Life	$70^{\circ}C \pm 2^{\circ}C$, 1000 hours ,at rated power 1.5hours "ON", 0.5hours "OFF"	$ \Delta R \leq \pm(2\% + 0.5 m\Omega)$	IEC 60115-1 4.25.1
Moisture Load Life (60°C、95%RH)	$T = 60^{\circ}C \pm 2^{\circ}C$; RH=95%; $V_{test} = V_{max}$. $t = 90min ON$, 30min OFF, 1000hours	$ \Delta R \leq \pm(2\% + 0.5 m\Omega)$	IEC 60115-1 4.24
Bending test	Bending width 2mm, Epoxy thickness 1.6mm, Fulcrums distance 90mm	$ \Delta R \leq \pm(1\% + 0.5 m\Omega)$	IEC 60115-1 4.33
High Temp. Exposure	$T = +155^{\circ}C \pm 2^{\circ}C$; $t = 1000$ hours	$ \Delta R \leq \pm(1\% + 0.5 m\Omega)$	IEC60115-1 4.25
Low Temp. Storage	$T = -55^{\circ}C \pm 2^{\circ}C$; $t = 1000$ hours	$ \Delta R \leq \pm(1\% + 0.5 m\Omega)$	IEC60115-1 4.25
Mechanical Shock	$a = 100G$, $t = 6msec$, 5 times shock	$ \Delta R \leq \pm(1\% + 0.5 m\Omega)$	IEC60115-1 4.21

Packaging

1. Tape Packaging Dimensions

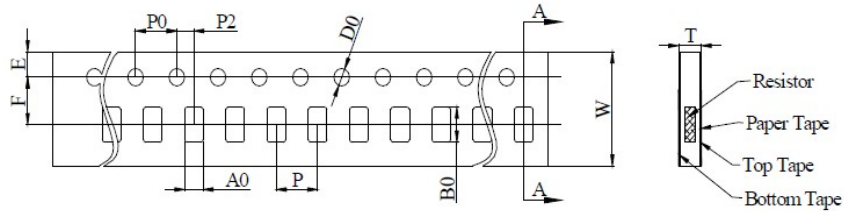

Type	A0 (mm)	B0 (mm)	W (mm)	F (mm)	E (mm)	T (mm)
0603	1.10±0.10	1.90±0.10	8.00±0.30	3.50±0.10	1.75±0.10	0.75±0.10
0805	1.55±0.10	2.30±0.10	8.00±0.30	3.50±0.10	1.75±0.10	0.87±0.10
1206	2.05±0.20	3.65±0.20	8.00±0.30	3.50±0.10	1.75±0.10	0.87±0.10
Type	P (mm)	P0 (mm)	P2 (mm)	D0 (mm)	/	/
0603	4.00±0.10	4.00±0.10	2.00±0.10	1.50±0.10	/	/
0805	4.00±0.10	4.00±0.10	2.00±0.10	1.50±0.10	/	/
1206	4.00±0.10	4.00±0.10	2.00±0.10	1.50±0.10	/	/

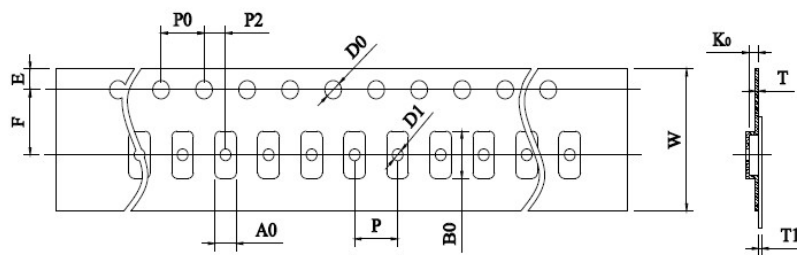

Type	A0 (mm)	B0 (mm)	W (mm)	F (mm)	E (mm)	T (mm)
2010	2.85±0.20	5.45±0.20	12.00±0.30	5.50±0.10	1.75±0.10	0.25±0.10
2512	3.40±0.20	6.75±0.20	12.00±0.30	5.50±0.10	1.75±0.10	0.25±0.10
Type	P (mm)	P0 (mm)	P2 (mm)	D0 (mm)	T1 (mm)	K0 (mm)
2010	4.00±0.10	4.00±0.10	2.00±0.10	1.50±0.10	0.1 Max.	0.80±0.20
2512	4.00±0.10	4.00±0.10	2.00±0.10	1.50±0.10	0.1 Max.	1.00±0.20

2. Reel Dimensions

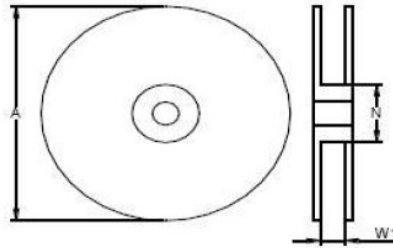

Type	A (mm)	N (mm)	W1 (mm)
0603	178.00±5.00	60.00±2.00	9.00±1.00
0805	178.00±5.00	60.00±2.00	9.00±1.00
1206	178.00±5.00	60.00±2.00	9.00±1.00
2010	178.00±5.00	60.00±2.00	13.00±1.00
2512	178.00±5.00	60.00±2.00	13.00±1.00

Quantity of Package

Type	0603	0805	1206	2010	2512
Quantity(pcs)	5000			4000	

Peeling Test

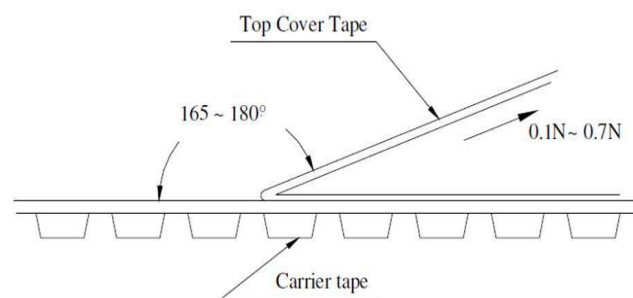

Storage

- The ambient temperature shall be between 5°C~30°C.
- The relative humidity recommended for storage is between 25%RH~60%RH.
- Sealed plastic bags with desiccant shall be used to reduce the oxidation of the termination and shall only be opened prior to use. The products shall not be stored in areas where harmful gases containing sulfur or chlorine are present.

单击下面可查看定价，库存，交付和生命周期等信息

[>>SART\(萨特\)](#)