

编号	SCTF202304369
日期	2023/4/18
版本	B01



# 承认书

## SPECIFICATION FOR APPROVAL

客户名称 Customer Name:	Customer
供应商物料名称 Part Name:	石英晶体谐振器
产品描述 Description:	HC-49US-SMD 25.000MHz/20pF
供应商物料料号 Part NO.:	SXMH25.000F2020F30
供应商名称 Supplier Name :	深圳市星通时频电子有限公司

PLEASE CONFIRM OUR SPECIFICATION. 敬请确认规格书之内容。

CUSTOMER APPROVAL 客户审批		
物料代号 PART NO. _____		
使用于机型 USED IN MODEL: _____		
工程部	品质部	采购部

(敬请承认后返回一份，谢谢！)

SUPPLIER APPROVAL 供应商审批		
DGN.制表人	CKD. 校对	APPD. 审核、签章
吴丽红	李霞	胡华才



# ■ QUARTZ CRYSTAL UNIT SPECIFICATION

## 1. Crystal Unit Spec:

N0.	Item	Symb.	Electrical spec.	Notes
1	Nominal Frequency 标称频率	f	25.000000 MHz	
2	Oscillation Mode 振荡模式		AT Fundamental	
3	Holder Type 封装		HC-49US-SMD	
4	Frequency Tolerance 常温频差	$\Delta f/f$	$\pm 20\text{ppm}$	at 25°C $\pm 2^\circ\text{C}$
5	Drive Level 激励功率	DL	100 $\mu\text{W}$	See the 2.1
6	Load Capacitance 负载电容	CL	20pF	See the 2.2
7	Effective Resistance 谐振电阻	RR	25 $\Omega$ max.	See the 2.3
8	Shunt Capacitance 静电容	C0	5 pF max.	
9	Drive Level Dependency 2 激励功率依赖性	DLD2	10 $\Omega$ max.	Sweep from 100nW to 100uW in 20 steps.
10	Temperature Drift 温度频差	f_tem	$\pm 30\text{ppm}$	Over Operating Temp. Range (Reference 25°C)
11	Spurious response 寄生响应	SPDB	-3dB max.	Start -1000ppm stop 5000ppm 30 steps power applied: 10dBm
12	Operating Temperature 工作温度范围	T_use	-40~85°C	
13	Storage Temperature Range 存储温度	T_stg	-40~105°C	
14	Insulation Resistance 绝缘阻抗	IR	500 M $\Omega$	at DC 100V
15	Aging 年老化率	f_age	$\pm 3$ ppm	1st Year
16	Measurement Condition 测量条件	Measured by S&A250B or equivalent, TA=25°C $\pm 2^\circ\text{C}$ , RH=40%~70%.		

## 2. Circuit Conditions Spec:

2.1 Drive Level (DL) 500 $\mu\text{W}$  max.

(If Drive Level is too high, that may cause crystal resonator abnormal oscillation or damaged the main body of quartz.)

2.2 Loading capacitance (CL) : 20pF

(The total circuit load capacitance should be equal to the crystal (CL) values, too large or too small load, will result in frequency drift.)

2.3 Negative Resistance (-R)  $\geq 125\Omega$

(If -R more than ESR spec of 5 times will be better. If Negative Resistance is too low, that may cause resonator stop oscillation or not easy to oscillate)

SHENZHEN SCTF ELECTRONICS CO. , LTD		
DATE	Specification of quartz crystal 石英晶体谐振器规格书	Page:
2023/4/18	P/N: SXMH25.000F2020F30 Spec.NO.: SCTF202304369	3

## ■ DIMENSIONS

Units (单位): mm(毫米)

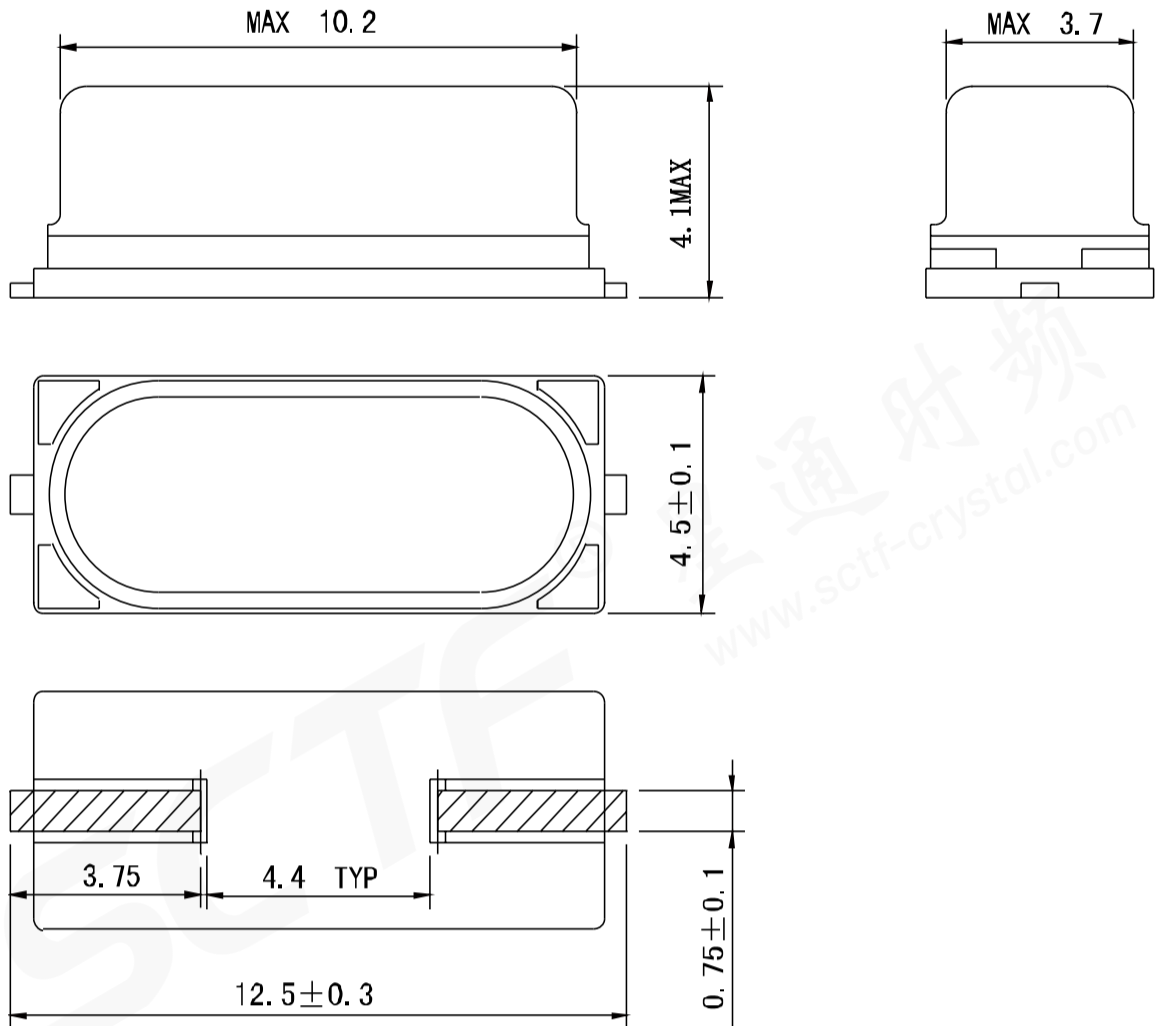

SHENZHEN SCTF ELECTRONICS CO. , LTD		
DATE	Specification of quartz crystal 石英晶体谐振器规格书	Page:
2023/4/18	P/N: SXMH25.000F2020F30 Spec.NO.: SCTF202304369	4

## ■ PRODUCT STRUCTURE & MARKING

### ◆ Product Structure 产品规格

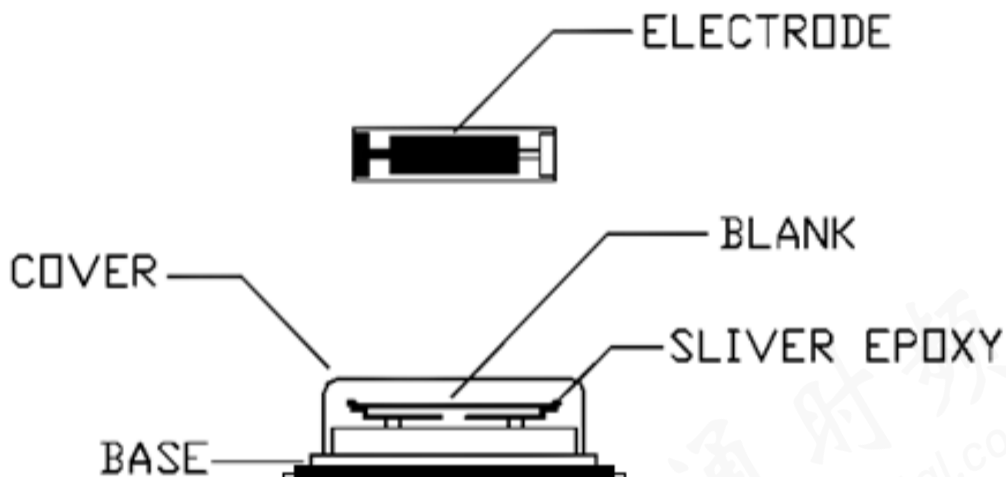

### ◆ Marking 印字

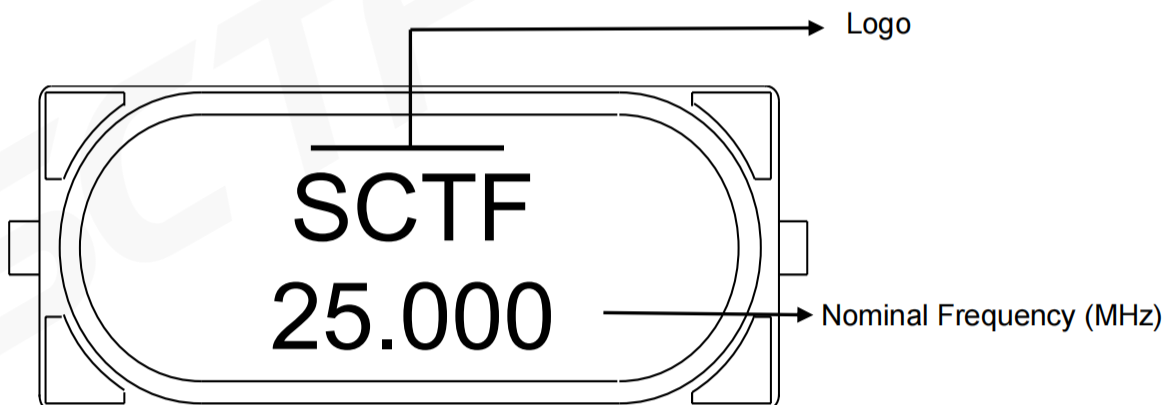

SHENZHEN SCTF ELECTRONICS CO. , LTD		
DATE	Specification of quartz crystal 石英晶体谐振器规格书	Page:
2023/4/18	P/N: SXMH25.000F2020F30 Spec.NO.: SCTF202304369	5

## REFLOW PROFILES

Profile Feature	Sn-Pb Eutectic Assembly	Pb-Free Assembly
Preheat/Soak		
● Temperature Min ( $T_s$ min)	100 °C	150 °C
● Temperature Max ( $T_s$ max)	150 °C	200 °C
● Time ( $T_s$ min to $T_s$ max)	60-120 seconds	60-120 seconds
Ramp-up rate ( $T_L$ to $T_p$ )	3 °C/second max.	3 °C/second max.
Time maintained above		
● Liquidous temperature ( $T_L$ )	183 °C	217 °C
● Time ( $t_L$ ) maintained above $T_L$	60-150 seconds	60-150 seconds
Peak package body temperature ( $T_p$ )	235 °C	260 °C
Time within 5 °C of the specified classification temperature ( $T_p$ )	20 seconds	30 seconds
Ramp-down rate ( $T_p$ to $T_L$ )	6 °C/second max.	6 °C/second max.
Time 25 °C to peak temperature	6 minutes max.	8 minutes max.
<b>Suggest reflow times</b>	<b>2 Times max.</b>	

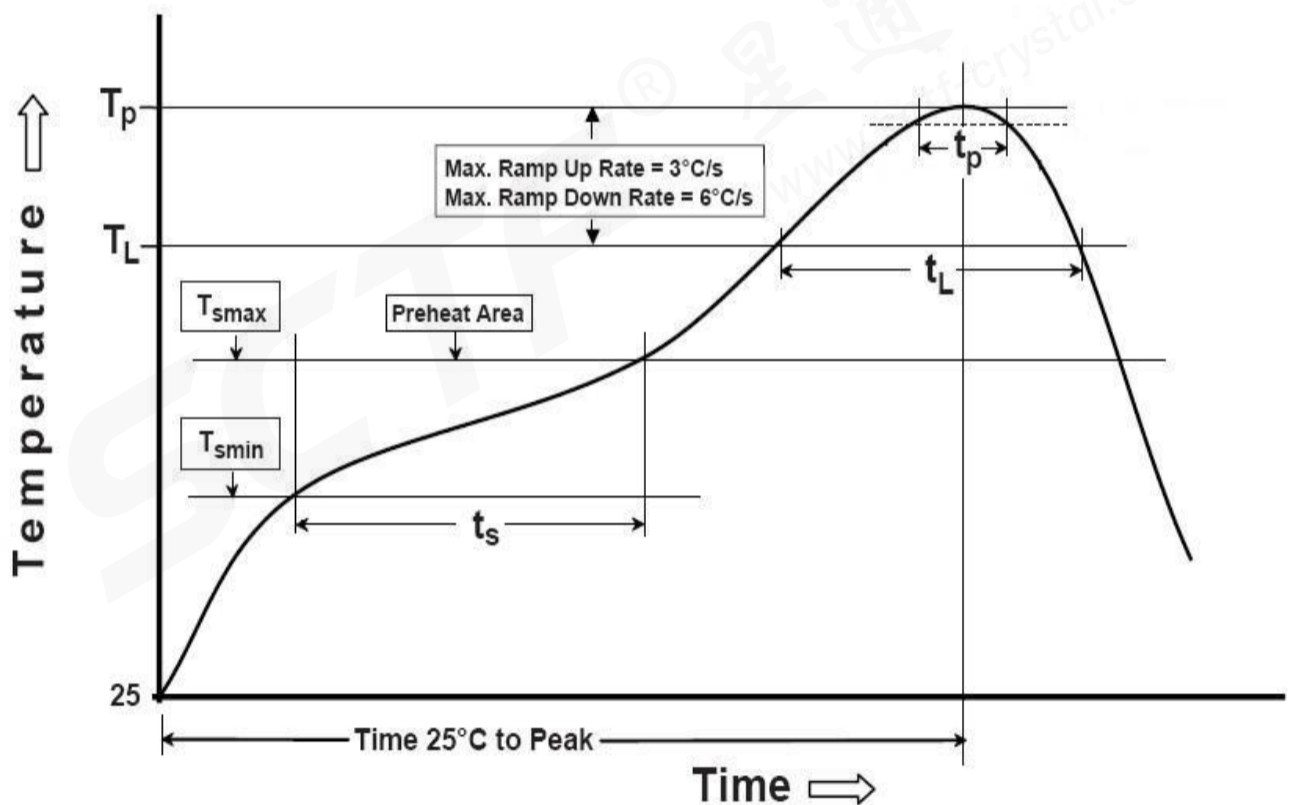

SHENZHEN SCTF ELECTRONICS CO. , LTD

DATE	Specification of quartz crystal 石英晶体谐振器规格书	Page:
2023/4/18	P/N: SXMH25.000F2020F30 Spec.NO.: SCTF202304369	6

## RELIABILITY SPECIFICATION

序号 NO.	项目 ITEM	条件 CONDITIONS	合格标准 BASIS OF VERDICT
1	跌落 DROP	75 cm高处自由跌落到3cm厚木板上,3次 High: 75 cm;Thickness:3cm;3 times.	$\Delta FL \leq \pm 5 \text{ppm}$ $\Delta RR \leq RR(\text{max}) * 10\%$
2	振动 VIBRATION	频率 Frequency:10~57.7Hz:幅度 Amplitude: $\pm 0.75 \text{mm}$ 频率Frequency:57.7Hz~500Hz:加速度幅度acceleration rate:98m/s <sup>2</sup> 周期 Cycle time:10-500-10Hz: 15min 振动方向 Direction:X,Y, Z 振动时间 Duration: 每个方向2小时 2 h/direction.	$\Delta FL \leq \pm 5 \text{ppm}$ $\Delta RR \leq RR(\text{max}) * 10\%$
3	温度变化 TEMPERATURE SHOCK	-40°C $\pm 2^\circ\text{C}$ (30min) $\leftrightarrow$ 85°C $\pm 2^\circ\text{C}$ (30min);循环10次 -40°C $\pm 2^\circ\text{C}$ (30min) $\leftrightarrow$ 85°C $\pm 2^\circ\text{C}$ (30min);For 10 cycles	$\Delta FL \leq \pm 5 \text{ppm}$ $\Delta RR \leq RR(\text{max}) * 10\%$
4	湿热 HUMIDITY	温度:40°C $\pm 2^\circ\text{C}$ ;湿度90-95%;时间:96小时 Temp:40°C $\pm 2^\circ\text{C}$ ;Humidity:90-95%;Times:96h	$\Delta FL \leq \pm 5 \text{ppm}$ $\Delta RR \leq RR(\text{max}) * 10\%$
5	低温 COLD RESISTANCE	温度:-40°C $\pm 2^\circ\text{C}$ ;时间:96小时 Temp:-40°C $\pm 2^\circ\text{C}$ ;Times:96h	$\Delta FL \leq \pm 5 \text{ppm}$ $\Delta RR \leq RR(\text{max}) * 10\%$
6	高温1 HEAT RESISTANCE 1	温度:100°C $\pm 2^\circ\text{C}$ ;时间:96小时 Temp:100°C $\pm 2^\circ\text{C}$ ;Times:96h	$\Delta FL \leq \pm 5 \text{ppm}$ $\Delta RR \leq RR(\text{max}) * 10\%$
7	高温2 HEAT RESISTANCE 2	温度:155°C $\pm 2^\circ\text{C}$ ;时间:2小时 Temp:155°C $\pm 2^\circ\text{C}$ ;Times:2h	$\Delta FL \leq \pm 5 \text{ppm}$ $\Delta RR \leq RR(\text{max}) * 10\%$
8	回流焊 REFLOW	150°C $\pm 5^\circ\text{C}$ 保持120s后升到270°C $\pm 5^\circ\text{C}$ 保持10s, 升温和保 温时间小于200s, 常温放置1~2h后测定 Keep 150 °C $\pm$ 5 °C 120s and then rose to 270 °C $\pm$ 5 °C for 10s, warming and holding time is less than the 200s, placed at room temperature 1 ~ 2h after test	$\Delta FL \leq \pm 5 \text{ppm}$ $\Delta RR \leq RR(\text{max}) * 10\%$
9	盐雾 SALT SPRAY	盐雾浓度:5%;温度:35°C;时间:8小时 Salt density:5%;Temp:35°C;Times:8h	目测无明显腐蚀现象 Visual no significant corrosion.
10	老化 AGING	温度:85°C;时间:30天 Temp:85°C;Times:30days	$\Delta FL \leq \pm 5 \text{ppm}$ $\Delta RR \leq RR(\text{max}) * 10\%$
11	气密性 LEAKAGE	氦气(0.6~0.65MPa):10分钟 He(0.6~0.65MPa):10min	$\leq 3 * 10^{-9} \text{Pa} \cdot \text{m}^3 / \text{s}$
12	焊接 SOLDER	温度:260°C $\pm 5^\circ\text{C}$ Temp:260°C $\pm 5^\circ\text{C}$	浸锡率大于90% Soldering tin rate greater than 90%

### SHENZHEN SCTF ELECTRONICS CO. , LTD

DATE	Specification of quartz crystal 石英晶体谐振器规格书	Page:
2023/4/18	P/N: SXMH25.000F2020F30 Spec.NO.: SCTF202304369	7

# PACKAGE

## ◆ Taping Specifications 编带规格

UNIT(单位):mm(毫米)

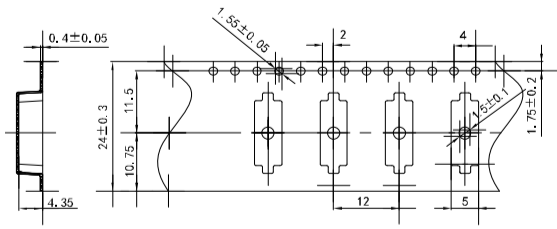

A局部视图

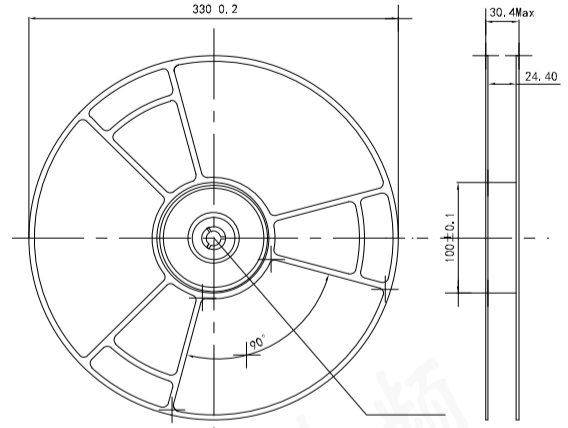
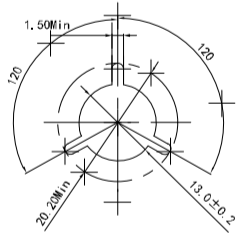

## ◆ Packaging specifications 包装规格

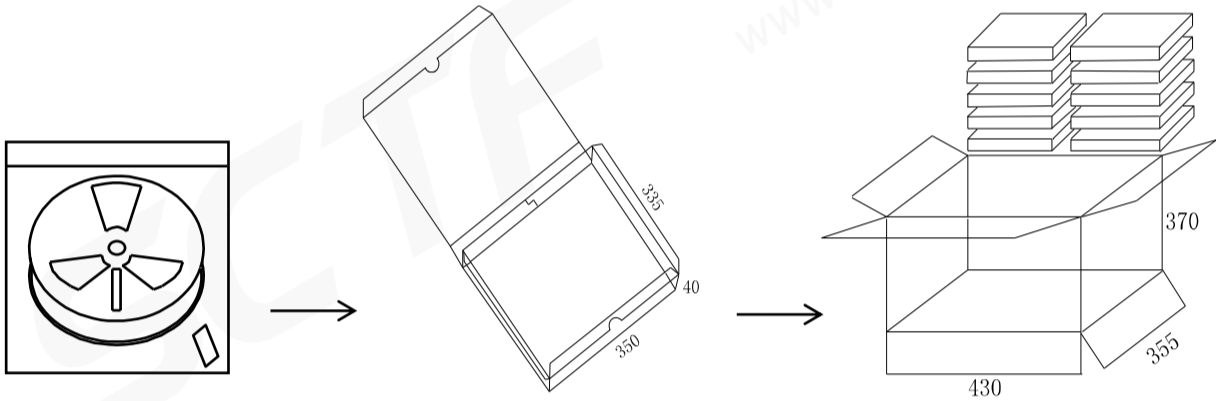

自封袋 (Bag)  
1000只 = 1 轮  
1000pcs = 1 Reel

内包装 (Inside package)  
1 轮 = 1 盒  
1 Reel = 1 box

外包装 (Outside Package )  
10 盒 = 1 箱  
10 box = 1 carton

<b>SHENZHEN SCTF ELECTRONICS CO., LTD</b>		
<b>DATE</b>	<b>Specification of quartz crystal</b> 石英晶体谐振器规格书	<b>Page:</b>
<b>2023/4/18</b>	<b>P/N: SXMH25.000F2020F30</b> <b>Spec.NO.: SCTF202304369</b>	<b>8</b>



单击下面可查看定价，库存，交付和生命周期等信息

[>>SCTF\(星通时频\)](#)