

编号	SCTF202304769
日期	2023/4/19
版本	B01



承认书

SPECIFICATION FOR APPROVAL

客户名称 Customer Name:	Customer
供应商物料名称 Part Name:	石英晶体振荡器
产品描述 Description:	SMD5032 32.000MHz/1.62~3.63V
供应商物料料号 Part NO.:	SX5M32.000M20F30TNN
供应商名称 Supplier Name :	深圳市星通时频电子有限公司

PLEASE CONFIRM OUR SPECIFICATION. 敬请确认规格书之内容。

CUSTOMER APPROVAL 客户审批		
物料代号 PART NO. _____		
使用于机型 USED IN MODEL: _____		
工程部	品质部	采购部

(敬请承认后返回一份, 谢谢!)

SUPPLIER APPROVAL 供应商审批		
DGN.制表人	CKD. 校对	APPD. 审核、签章
吴丽红	李霞	胡华才



RoHS Compliant

Revision Record				
Rev.	Revise page 修订页	Revise contents 修订内容	Rev. Date 修订日期	Reviser 修订人
A02	N/A	Initial released.	2013/1/1	Martin.Hu
A03	N/A	The version is upgraded and the content remains unchanged.	2018/2/25	Martin.Hu
B01	Page2	The version is upgraded and add revision record page.	2021/2/24	Martin.Hu

SHENZHEN SCTF ELECTRONICS CO., LTD		
DATE	Specification of quartz crystal oscillator 石英晶体振荡器规格书	Page:
2023/4/19	P/N: SX5M32.000M20F30TNN Spec.NO.: SCTF202304769	2

■ Electrical Specification 电气参数

N0.	Item	Electrical Spec.	Notes
1	Holder Type 封装	SMD5032	
2	Nominal Frequency 标称频率	32.000000 MHz	
3	Frequency stability 常温频差	±20ppm	at 25°C±2°C
4	Temperature Drift 温度频差	±30ppm	at -40~85°C
5	Operating voltage 工作电压	1.62~3.63V	
6	Output 输出模式	CMOS	
7	Output load condition 负载	15pF	
8	Current consumption 消耗电流	20 mA max.	
9	Operating temperature range 工作温度范围	-40~85°C	
10	Storage Temperature Range 存储温度范围	-55~125°C	
11	Duty Cycle 占空比	45%-55%	
12	Rise / Fall Time 上升/下降沿时间	5 nS max.	
13	High output voltage 高电平	0.9Vdd min.	
14	Low output voltage 低电平	0.1Vdd max.	
15	Start-up Time 起振时间	5mS max.	To 90% of Final Amplitude
16	Enable Voltage High (Logic 1) 使能高电平	70%VDD min.	Output will be enable if OE is Logic 1 or open ; Output will be disable if OE is Logic 0. 输出使能OE是高电平1或者悬空，频率输出； 输出使能OE是低电平0，则无频率输出。
17	Enable Voltage Low (Logic 0) 使能低电平	30%VDD max.	
18	Enable Delay Time 使能延迟	150 uS max..	
19	Aging 老化	±3ppm	1st. Year at 25°C

SHENZHEN SCTF ELECTRONICS CO. , LTD

DATE	Specification of quartz crystal oscillator 石英晶体振荡器规格书	Page:
2023/4/19	P/N: SX5M32.000M20F30TNN Spec.NO.: SCTF202304769	3

■ DIMENSIONS 产品尺寸

Units (单位): mm(毫米)

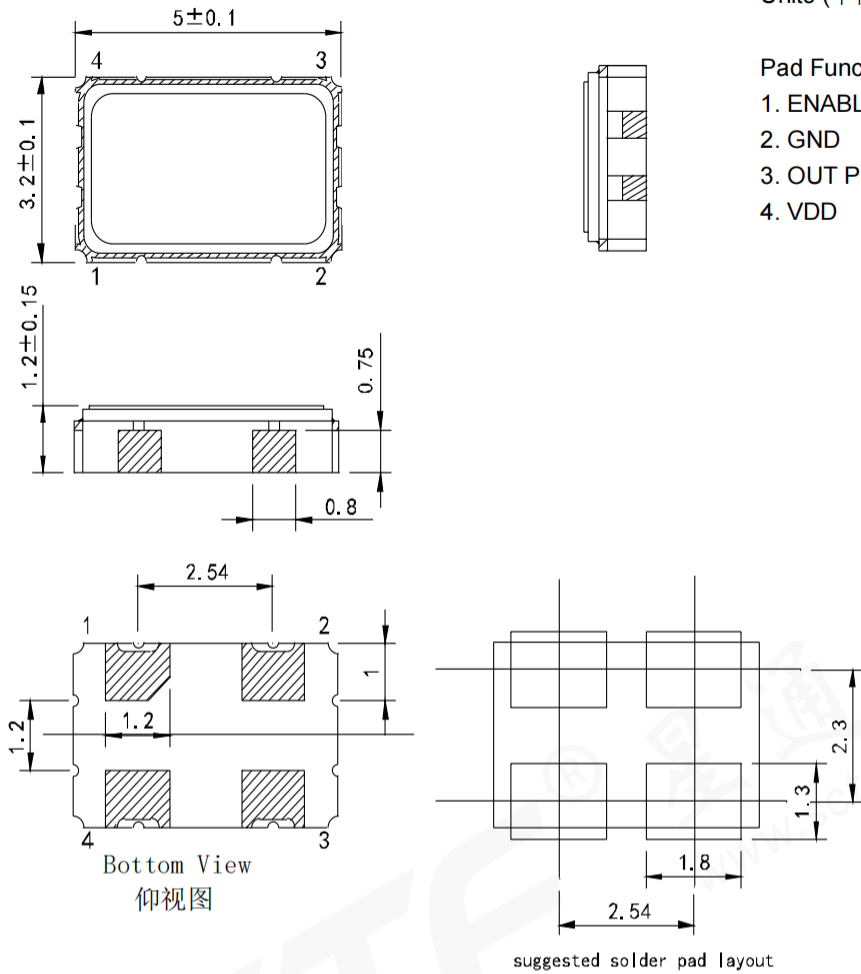

Pad Functions:

1. ENABLE CONTROL
2. GND
3. OUT PUT
4. VDD

■ TESTING CIRCUIT 测试电路

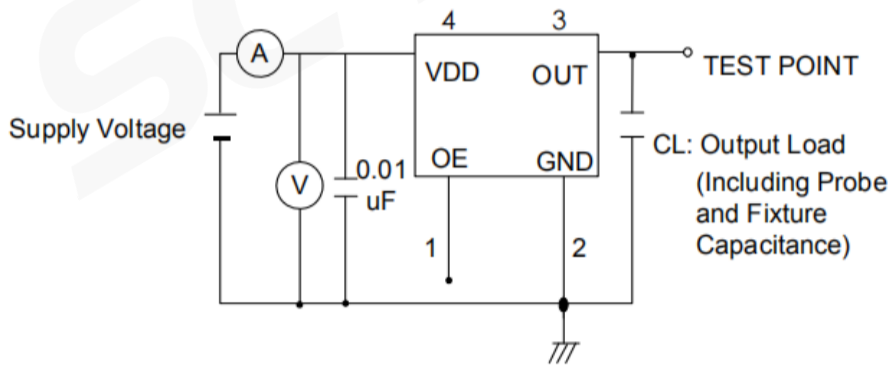

※ Notes: PIN 1 connected to Vdd or floating, the product is working properly; connected to GND, stops working.

SHENZHEN SCTF ELECTRONICS CO. , LTD		
DATE	Specification of quartz crystal oscillator 石英晶体振荡器规格书	Page:
2023/4/19	P/N: SX5M32.000M20F30TNN Spec.NO.: SCTF202304769	4

■ **WAVEFORM CONDITIONS** 输出波形



Waveform measurement system should have a min. bandwidth of 5 times the frequency being tested.

■ **Product Structure** 产品结构

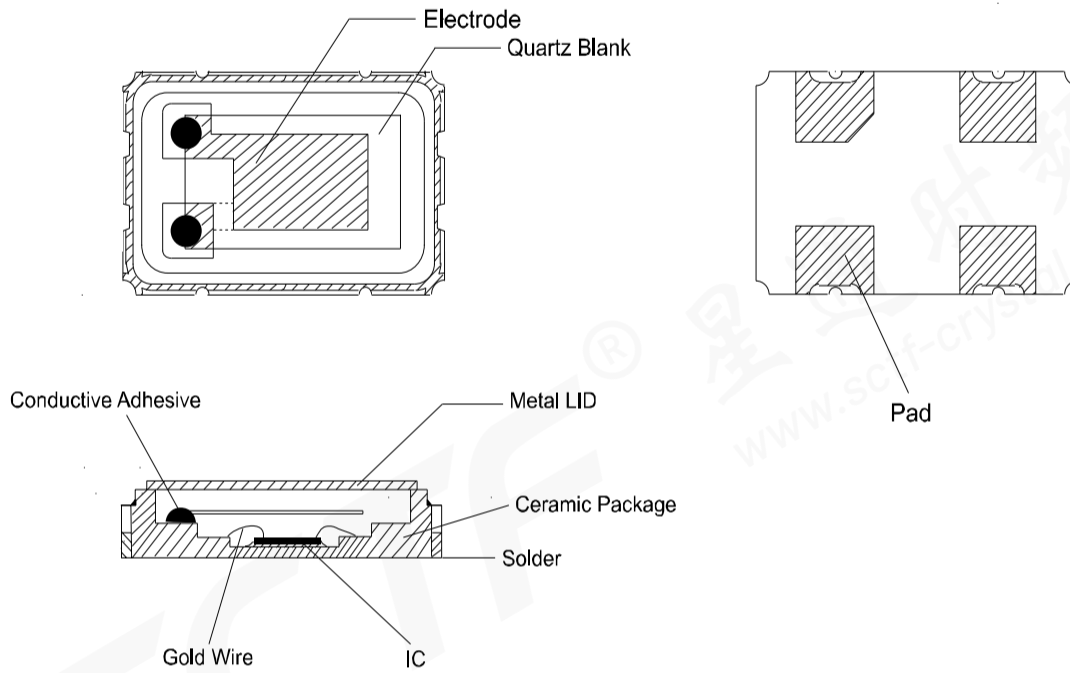

■ **Marking** 印字

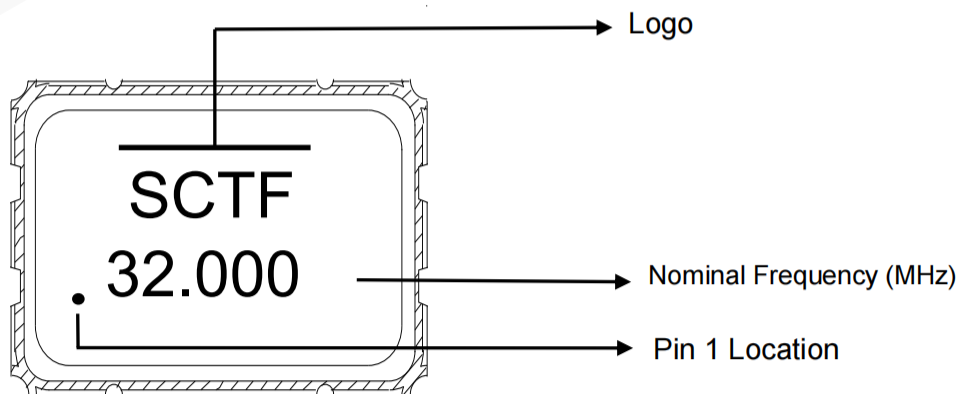

SHENZHEN SCTF ELECTRONICS CO. , LTD		
DATE	Specification of quartz crystal oscillator 石英晶体振荡器规格书	Page:
2023/4/19	P/N: SX5M32.000M20F30TNN Spec.NO.: SCTF202304769	5

REFLOW PROFILES 回流焊条件

Profile Feature	Sn-Pb Eutectic Assembly	Pb-Free Assembly
Preheat/Soak		
● Temperature Min (Ts min)	100 °C	150 °C
● Temperature Max (Ts max)	150 °C	200 °C
● Time (Ts min to Ts max)	60-120 seconds	60-120 seconds
Ramp-up rate (TL to Tp)	3 °C/second max.	3 °C/second max.
Time maintained above		
● Liquidous temperature (TL)	183 °C	217 °C
● Time (tL) maintained above TL	60-150 seconds	60-150 seconds
Peak package body temperature (Tp)	235 °C	260 °C
Time within 5 °C of the specified classification temperature (Tp)	20 seconds	30 seconds
Ramp-down rate (Tp to TL)	6 °C/second max.	6 °C/second max.
Time 25 °C to peak temperature	6 minutes max.	8 minutes max.
Suggest reflow times	3 Times max.	



SHENZHEN SCTF ELECTRONICS CO., LTD

DATE	Specification of quartz crystal oscillator 石英晶体振荡器规格书	Page:
2023/4/19	P/N: SX5M32.000M20F30TNN Spec.NO.: SCTF202304769	6

■ RELIABILITY SPECIFICATION 可靠性参数

序号 NO.	项目 ITEM	条件 CONDITIONS	合格标准 BASIS OF VERDICT
1	跌落 DROP	100cm高处自由跌落到3cm厚木板上,3次 High: 100cm; Thickness: 3cm; 3 times.	$\Delta FL \leq \pm 5 \text{ppm}$
2	振动 VIBRATION	频率 Frequency: 10~57.7Hz; 幅度 Amplitude: $\pm 0.75 \text{mm}$ 频率 Frequency: 57.7Hz~500Hz; 加速度幅度 acceleration rate: 98m/s^2 周期 Cycle time: 10-500-10Hz: 15min 振动方向 Direction: X, Y, Z 振动时间 Duration: 每个方向2小时 2 h/direction.	$\Delta FL \leq \pm 5 \text{ppm}$
3	温度变化 TEMPERATURE SHOCK	$-40^\circ\text{C} \pm 2^\circ\text{C}$ (30min) \leftrightarrow $85^\circ\text{C} \pm 2^\circ\text{C}$ (30min); 循环10次 $-40^\circ\text{C} \pm 2^\circ\text{C}$ (30min) \leftrightarrow $85^\circ\text{C} \pm 2^\circ\text{C}$ (30min); For 10 cycles	$\Delta FL \leq \pm 5 \text{ppm}$
4	湿热 HUMIDITY	温度: $40^\circ\text{C} \pm 2^\circ\text{C}$; 湿度 90-95%; 时间: 96小时 Temp: $40^\circ\text{C} \pm 2^\circ\text{C}$; Humidity: 90-95%; Times: 96h	$\Delta FL \leq \pm 5 \text{ppm}$
5	低温 COLD RESISTANCE	温度: $-40^\circ\text{C} \pm 2^\circ\text{C}$; 时间: 96小时 Temp: $-40^\circ\text{C} \pm 2^\circ\text{C}$; Times: 96h	$\Delta FL \leq \pm 5 \text{ppm}$
6	高温1 HEAT RESISTANCE 1	温度: $100^\circ\text{C} \pm 2^\circ\text{C}$; 时间: 96小时 Temp: $100^\circ\text{C} \pm 2^\circ\text{C}$; Times: 96h	$\Delta FL \leq \pm 5 \text{ppm}$
7	高温2 HEAT RESISTANCE 2	温度: $155^\circ\text{C} \pm 2^\circ\text{C}$; 时间: 2小时 Temp: $155^\circ\text{C} \pm 2^\circ\text{C}$; Times: 2h	$\Delta FL \leq \pm 5 \text{ppm}$
8	高温3 HEAT RESISTANCE 3	温度: $85^\circ\text{C} \pm 2^\circ\text{C}$; 电压: 3.3V/5.0V; 时间: 96小时 Temp: $85^\circ\text{C} \pm 2^\circ\text{C}$; Voltage: 3.3V/5.0V; Times: 96h	$\Delta FL \leq \pm 5 \text{ppm}$
9	回流焊 REFLOW	$150^\circ\text{C} \pm 5^\circ\text{C}$ 保持 120s 后升到 $270^\circ\text{C} \pm 5^\circ\text{C}$ 保持 10s, 升温 and 保温时间小于 200s, 常温放置 1~2h 后测定 Keep $150^\circ\text{C} \pm 5^\circ\text{C}$ 120s and then rose to $270^\circ\text{C} \pm 5^\circ\text{C}$ for 10s, warming and holding time is less than the 200s, placed at room temperature 1 ~ 2h after test	$\Delta FL \leq \pm 5 \text{ppm}$
10	盐雾 SALT SPRAY	盐雾浓度: 5%; 温度: 35°C ; 时间: 24小时 Salt density: 5%; Temp: 35°C ; Times: 24h	目测无明显腐蚀现象 Visual no significant corrosion.
11	老化 AGING	温度: 85°C ; 时间: 30天 Temp: 85°C ; Times: 30days	$\Delta FL \leq \pm 5 \text{ppm}$
12	气密性 LEAKAGE	氦气 (0.6~0.65MPa): 10分钟 He (0.6~0.65MPa): 10min	$\leq 3 \times 10^{-9} \text{Pa} \cdot \text{m}^3/\text{s}$
13	焊接 SOLDER	温度: $260^\circ\text{C} \pm 5^\circ\text{C}$ Temp: $260^\circ\text{C} \pm 5^\circ\text{C}$	浸锡率大于 90% Soldering tin rate greater than 90%

SHENZHEN SCTF ELECTRONICS CO., LTD

DATE	Specification of quartz crystal oscillator 石英晶体振荡器规格书	Page:
2023/4/19	P/N: SX5M32.000M20F30TNN Spec.NO.: SCTF202304769	7

◆ Taping Specifications 编带参数

UNIT(单位):mm(毫米)

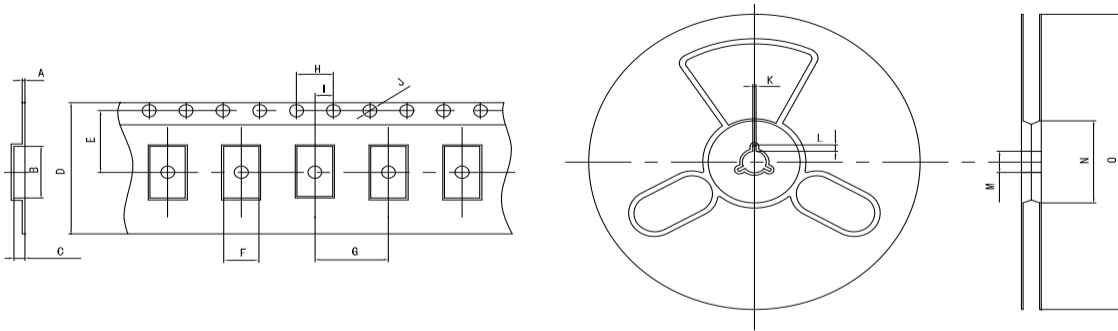

TEYE	A	B	C	D	E	F	G	H	I	J	K	L	M	N	O
5×3.2 SMD	0.30	7.50	1.50	12.00	5.50	3.70	8.00	4.00	2.00	1.50	2.00	4.00	13.00	60.00	180.00

◆ Packaging specifications 包装参数

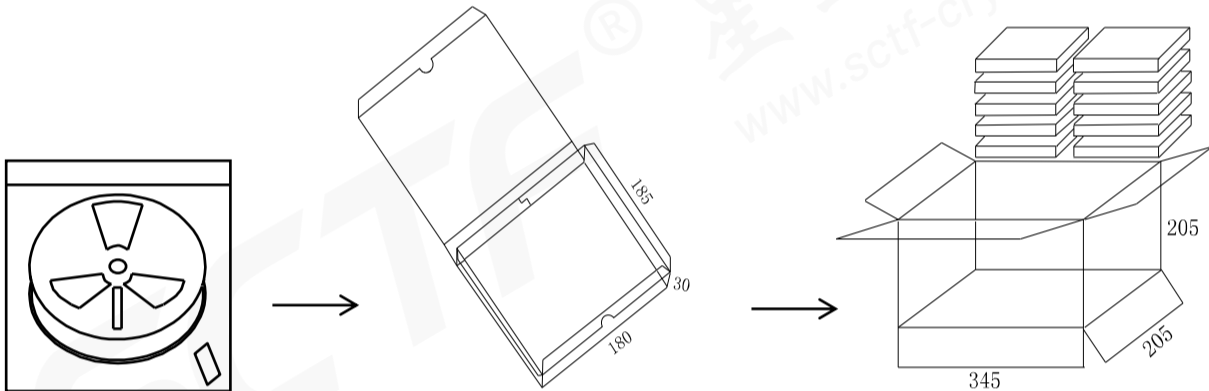

自封袋 (Bag)
1000只 = 1 轮
1000pcs = 1 Reel

内包装 (Inside package)
1 轮=1 盒
1 Reel=1 box

外包装 (Outside Package)
10 盒=1 箱
10 box=1 carton

SHENZHEN SCTF ELECTRONICS CO. , LTD		
DATE	Specification of quartz crystal oscillator 石英晶体振荡器规格书	Page:
2023/4/19	P/N: SX5M32.000M20F30TNN Spec.NO.: SCTF202304769	8

单击下面可查看定价，库存，交付和生命周期等信息

[>>SCTF\(星通时频\)](#)