

| | |
|----|--------------|
| 编号 | SCTF2021X570 |
| 日期 | 2021-9-30 |
| 版本 | B01 |

承认书

SPECIFICATION FOR APPROVAL

| | |
|-----------------------|------------------------|
| 客户名称 Customer Name: | 0 |
| 供应商物料名称 Part Name: | 石英晶体振荡器 |
| 产品描述 Description: | SMD3225 40.000MHz/5.0V |
| 供应商物料料号 Part NO.: | SX3M40.000A20F30TNN |
| 供应商名称 Supplier Name : | 深圳市星通时频电子有限公司 |

PLEASE CONFIRM OUR SPECIFICATION. 敬请确认规格书之内容。

| CUSTOMER APPROVAL 客户审批 | | |
|----------------------------|-----|-----|
| 物料代号 PART NO. _____ | | |
| 使用于机型 USED IN MODEL: _____ | | |
| 工程部 | 品质部 | 采购部 |
| | | |

(敬请确认后返回一份, 谢谢!)

| SUPPLIER APPROVAL 供应商审批 | | |
|-------------------------|---------|-------------|
| DGN.制表人 | CKD. 校对 | APPD. 审核、签章 |
| 陈雪娟 | 李霞 | 胡华才 |

RoHS Compliant

| Revision Record | | | | |
|-----------------|--------------------|--|-------------------|----------------|
| Rev. | Revise page 修订页 | Revise contents 修订内容 | Rev. Date 修订日期 | Reviser 修订人 |
| A02 | N/A | Initial released. | 2013-1-1 | Martin.Hu |
| A03 | N/A | The version is upgraded and the content remains unchanged. | 2018-2-25 | Martin.Hu |
| B01 | Page2 | The version is upgraded and add revision record page. | 2021-2-24 | Martin.Hu |
| | | | | |
| | | | | |
| | | | | |
| | | | | |
| | | | | |
| | | | | |
| | | | | |
| | | | | |
| | | | | |
| | | | | |
| | | | | |
| | | | | |
| | | | | |
| | | | | |
| | | | | |
| | | | | |
| | | | | |
| | | | | |
| | | | | |
| | | | | |
| | | | | |

| SHENZHEN SCTF ELECTRONICS CO. , LTD | | |
|-------------------------------------|--|-------|
| DATE | Specification of quartz crystal oscillator 石英晶体振荡器规格书 | Page: |
| 2021-9-30 | P/N: SX3M40.000A20F30TNN Spec.NO.: SCTF2021X570 | 2 |

■ Electrical Specification 电气参数

| N0. | Item | Electrical Spec. | Notes |
|-----|--|------------------|---|
| 1 | Holder Type 封装 | SMD3225 | |
| 2 | Nominal Frequency 标称频率 | 40.000000 MHz | |
| 3 | Frequency stability 常温频差 | ±20PPM | at 25°C±2°C |
| 4 | Temperature Drift 温度频差 | ±30PPM | at -40~85°C |
| 5 | Operating voltage 工作电压 | 5.0V | ±10% max. |
| 6 | Output 输出模式 | CMOS | |
| 7 | Output load condition 负载 | 15pF | |
| 8 | Current consumption 消耗电流 | 20 mA max. | |
| 9 | Operating temperature range 工作温度范围 | -40~85°C | |
| 10 | Storage Temperature Range 存储温度范围 | -55~125°C | |
| 11 | Duty Cycle 占空比 | 45%-55% | |
| 12 | Rise / Fall Time 上升/下降沿时间 | 3 nS max. | |
| 13 | High output voltage 高电平 | 0.9Vdd min. | |
| 14 | Low output voltage 低电平 | 0.1Vdd max. | |
| 15 | Start-up Time 起振时间 | 5mS max. | To 90% of Final Amplitude |
| 16 | Enable Voltage High (Logic 1) 使能高电平 | 70%Vdd min. | Output will be enable if OE is Logic 1 or open ; Output will be disable if OE is Logic 0. 输出使能OE是高电平1或者悬空，频率输出； 输出使能OE是低电平0，则无频率输出。 |
| 17 | Enable Voltage Low (Logic 0) 使能低电平 | 30%Vdd max.. | |
| 18 | Enable Delay Time 使能延迟 | 150 uS max. | |
| 19 | Aging 老化 | ±3ppm | 1st. Year at 25°C |

SHENZHEN SCTF ELECTRONICS CO. , LTD

| DATE | Specification of quartz crystal oscillator 石英晶体振荡器规格书 | Page: |
|-----------|--|-------|
| 2021-9-30 | P/N: SX3M40.000A20F30TNN Spec.NO.: SCTF2021X570 | 3 |

■ DIMENSIONS 产品尺寸

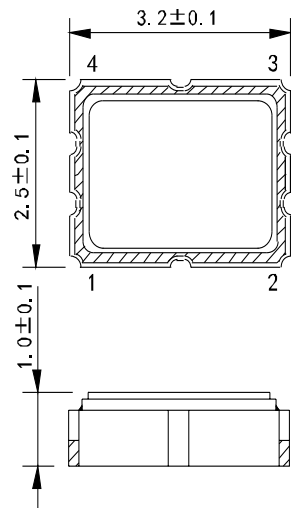

Units (单位): mm(毫米)

Pad Functions:

1. ENABLE CONTROL
2. GND
3. OUT PUT
4. VDD

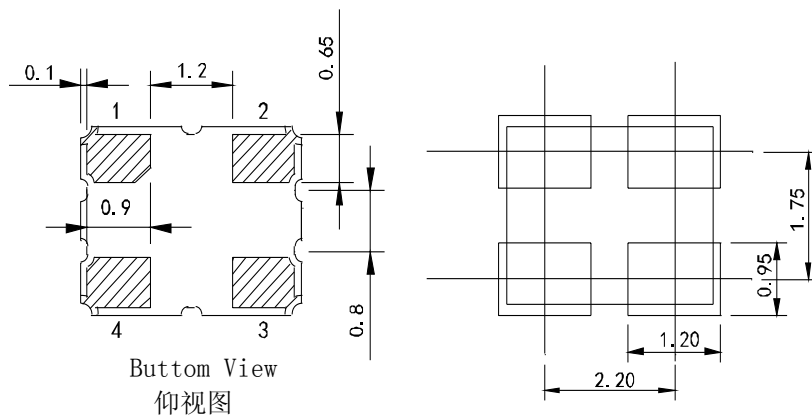

Bottom View
仰视图

※ Notes: PIN 1 connected to Vdd or floating, the product is working properly; connected to GND, stops working.

■ TESTING CIRCUIT 测试电路

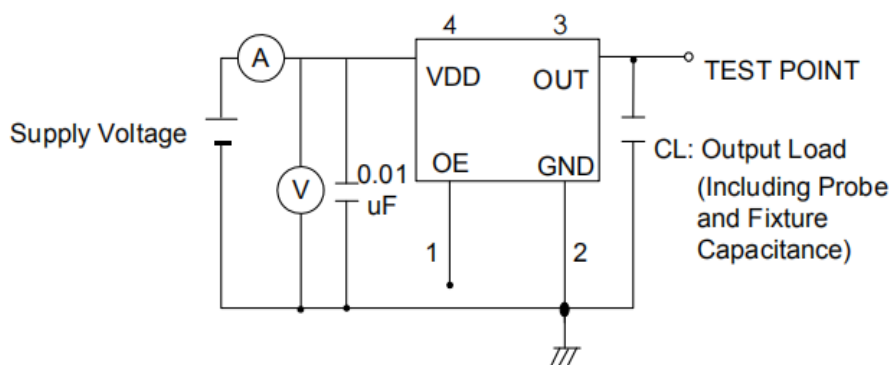

SHENZHEN SCTF ELECTRONICS CO. , LTD

| | | |
|-----------|--|-------|
| DATE | Specification of quartz crystal oscillator 石英晶体振荡器规格书 | Page: |
| 2021-9-30 | P/N: SX3M40.000A20F30TNN Spec.NO.: SCTF2021X570 | 4 |

■ WAVEFORM CONDITIONS 输出波形

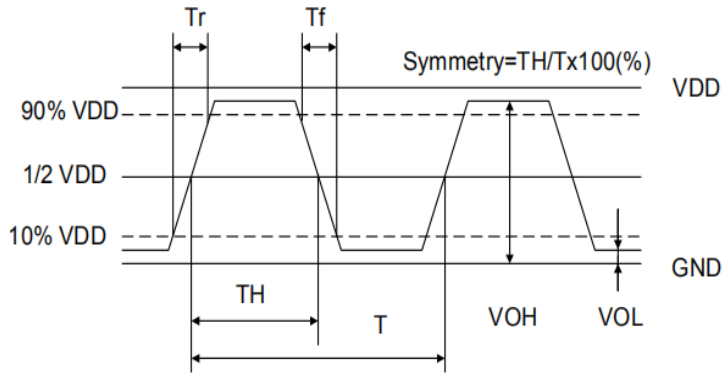

■ Product Structure

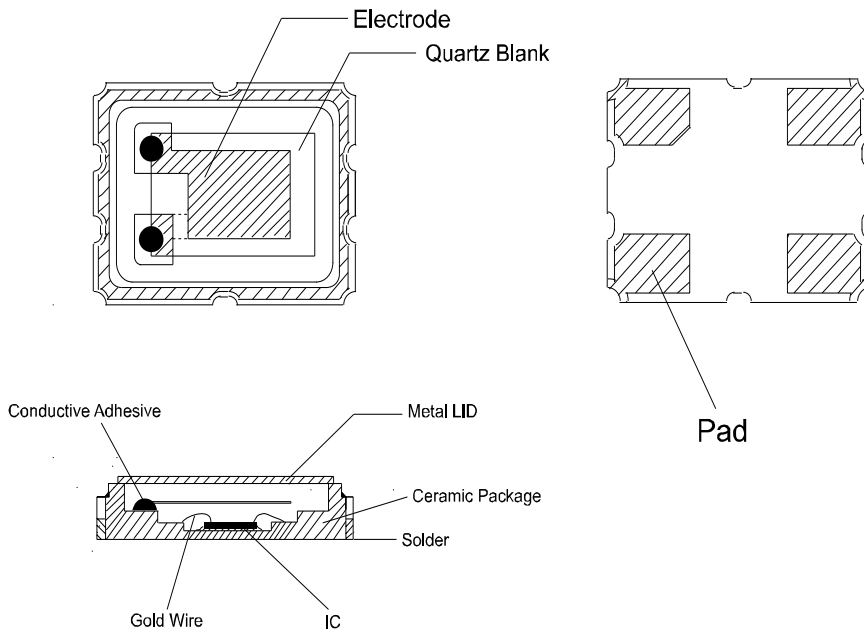

■ Marking

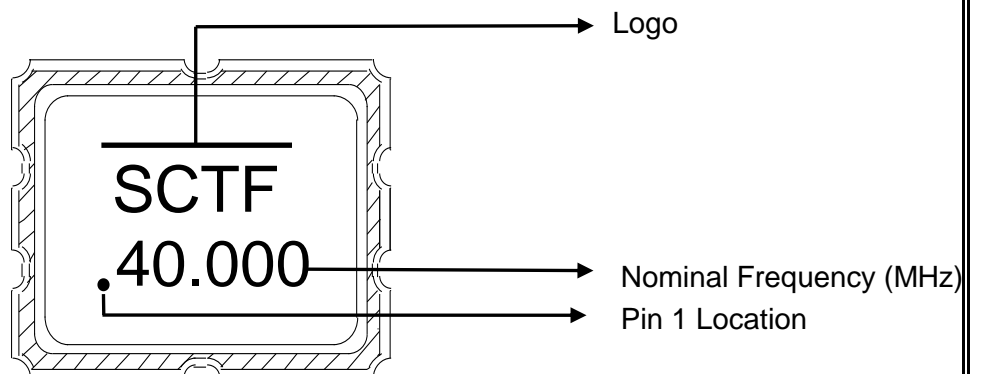

| SHENZHEN SCTF ELECTRONICS CO. , LTD | | |
|-------------------------------------|--|-------|
| DATE | Specification of quartz crystal oscillator 石英晶体振荡器规格书 | Page: |
| 2021-9-30 | P/N: SX3M40.000A20F30TNN Spec.NO.: SCTF2021X570 | 5 |

REFLOW PROFILES 回流焊条件

| Profile Feature | Sn-Pb Eutectic Assembly | Pb-Free Assembly |
|---|-------------------------|------------------|
| Preheat/Soak | | |
| ●Temperature Min(Ts min) | 100 °C | 150 °C |
| ●Temperature Max (Ts max) | 150 °C | 200 °C |
| ●Time (Ts min to Ts max) | 60-120 seconds | 60-120 seconds |
| Ramp-up rate (TL to Tp) | 3 °C/second max. | 3 °C/second max. |
| Time maintained above | | |
| ●Liquidous temperature (TL) | 183 °C | 217 °C |
| ●Time (tL) maintained above TL | 60-150 seconds | 60-150 seconds |
| Peak package body temperature (Tp) | 235°C | 260°C |
| Time within 5 °C of the specified classification temperature (Tp) | 20 seconds | 30 seconds |
| Ramp-down rate (Tp to TL) | 6 °C/second max. | 6 °C/second max. |
| Time 25 °C to peak temperature | 6 minutes max. | 8 minutes max. |
| Suggest reflow times | 3 Times max. | |

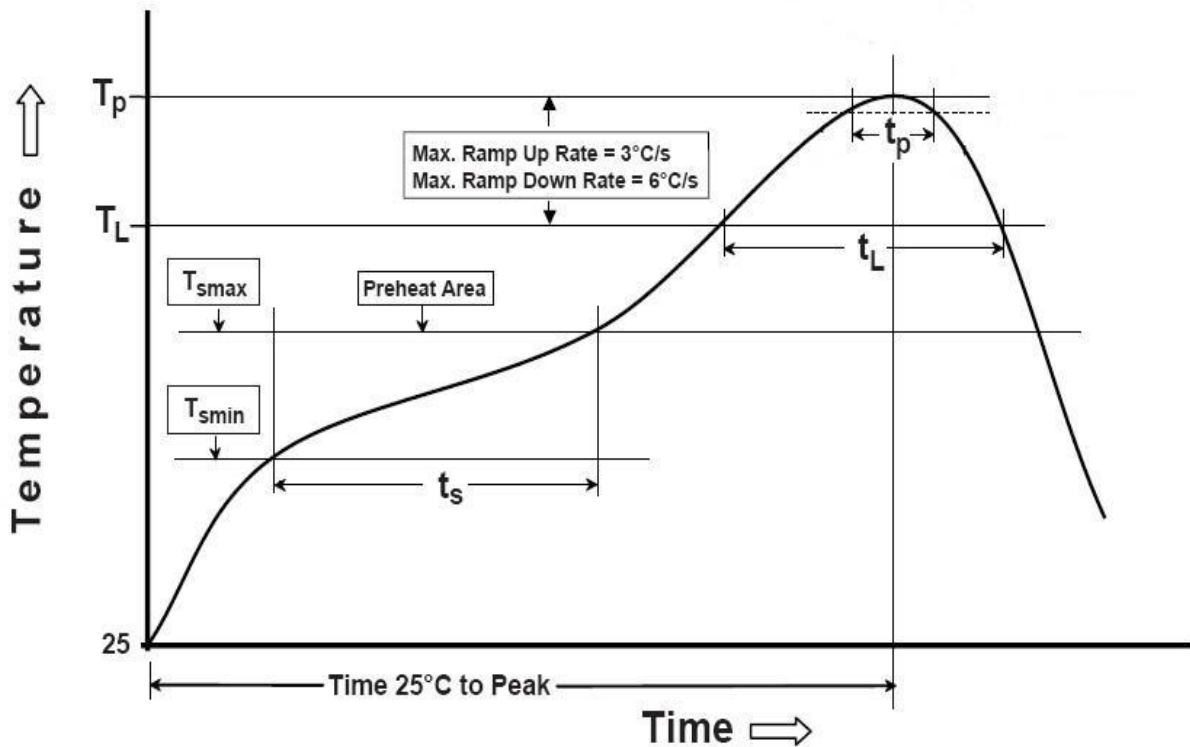

| SHENZHEN SCTF ELECTRONICS CO. , LTD | | |
|-------------------------------------|--|-------|
| DATE | Specification of quartz crystal oscillator 石英晶体振荡器规格书 | Page: |
| 2021-9-30 | P/N: SX3M40.000A20F30TNN Spec.NO.: SCTF2021X570 | 6 |

■ RELIABILITY SPECIFICATION 可靠性参数

| 序号 NO. | 项目 ITEM | 条件 CONDITIONS | 合格标准 BASIS OF VERDICT |
|-----------|---------------------------|--|---|
| 1 | 跌落 DROP | 100cm高处自由跌落到3cm厚木板上,3次 High:100cm;Thickness:3cm;3 times. | $\Delta FL \leq \pm 5 \text{ppm}$ |
| 2 | 振动 VIBRATION | 频率 Frequency:10~57.7Hz:幅度 Amplitude: $\pm 0.75 \text{mm}$ 频率Frequency:57.7Hz~500Hz:加速度幅度acceleration rate:98m/s ² 周期 Cycle time:10-500-10Hz: 15min 振动方向 Direction:X,Y, Z 振动时间 Duration: 每个方向2小时 2 h/direction. | $\Delta FL \leq \pm 5 \text{ppm}$ |
| 3 | 温度变化 TEMPERATURE SHOCK | -40°C $\pm 2^\circ\text{C}$ (30min) \leftrightarrow 85°C $\pm 2^\circ\text{C}$ (30min);循环10次 -40°C $\pm 2^\circ\text{C}$ (30min) \leftrightarrow 85°C $\pm 2^\circ\text{C}$ (30min);For 10 cycles | $\Delta FL \leq \pm 5 \text{ppm}$ |
| 4 | 湿热 HUMIDITY | 温度:40°C $\pm 2^\circ\text{C}$;湿度90-95%;时间:96小时 Temp:40°C $\pm 2^\circ\text{C}$;Humidity:90-95%;Times:96h | $\Delta FL \leq \pm 5 \text{ppm}$ |
| 5 | 低温 COLD RESISTANCE | 温度:-40°C $\pm 2^\circ\text{C}$;时间:96小时 Temp:-40°C $\pm 2^\circ\text{C}$;Times:96h | $\Delta FL \leq \pm 5 \text{ppm}$ |
| 6 | 高温1 HEAT RESISTANCE 1 | 温度:100°C $\pm 2^\circ\text{C}$;时间:96小时 Temp:100°C $\pm 2^\circ\text{C}$;Times:96h | $\Delta FL \leq \pm 5 \text{ppm}$ |
| 7 | 高温2 HEAT RESISTANCE 2 | 温度:155°C $\pm 2^\circ\text{C}$;时间:2小时 Temp:155°C $\pm 2^\circ\text{C}$;Times:2h | $\Delta FL \leq \pm 5 \text{ppm}$ |
| 8 | 高温3 HEAT RESISTANCE 3 | 温度:85°C $\pm 2^\circ\text{C}$;电压:3.3V/5.0V;时间:96小时 Temp:85°C $\pm 2^\circ\text{C}$;Voltage:3.3V/5.0V;Times:96h | $\Delta FL \leq \pm 5 \text{ppm}$ |
| 9 | 回流焊 REFLOW | 150°C $\pm 5^\circ\text{C}$ 保持120s后升到270°C $\pm 5^\circ\text{C}$ 保持10s, 升温 and 保温 时间小于200s, 常温放置1~2h后测定 Keep 150 °C \pm 5 °C 120s and then rose to 270 °C \pm 5 °C for 10s, warming and holding time is less than the 200s, placed at room temperature 1 ~ 2h after test | $\Delta FL \leq \pm 5 \text{ppm}$ |
| 10 | 盐雾 SALT SPRAY | 盐雾浓度:5%;温度:35°C;时间:24小时 Salt density:5%;Temp:35°C;Times:24h | 目测无明显腐蚀现象 Visual no significant corrosion. |
| 11 | 老化 AGING | 温度:85°C;时间:30天 Temp:85°C;Times:30days | $\Delta FL \leq \pm 5 \text{ppm}$ |
| 12 | 气密性 LEAKAGE | 氦气(0.6~0.65MPa):10分钟 He(0.6~0.65MPa):10min | $\leq 3 \times 10^{-9} \text{Pa} \cdot \text{m}^3/\text{s}$ |
| 13 | 焊接 SOLDER | 温度:260°C $\pm 5^\circ\text{C}$ Temp:260°C $\pm 5^\circ\text{C}$ | 浸锡率大于90% Soldering tin rate greater than 90% |

SHENZHEN SCTF ELECTRONICS CO., LTD

| DATE | Specification of quartz crystal oscillator 石英晶体振荡器规格书 | Page: |
|-----------|--|-------|
| 2021-9-30 | P/N: SX3M40.000A20F30TNN Spec.NO.: SCTF2021X570 | 7 |

■ Taping Specifications

UNIT(单位):mm(毫米)



| TEYE | A | B | C | D | E | F | G | H | I | J | K | L | M | N | O |
|-------------|------|------|------|------|------|------|------|------|------|------|------|------|-------|-------|--------|
| 3.2×2.5 SMD | 0.25 | 3.60 | 1.30 | 8.00 | 3.50 | 2.90 | 4.00 | 4.00 | 2.00 | 1.50 | 2.00 | 4.00 | 13.00 | 60.00 | 180.00 |

■ Packaging specifications

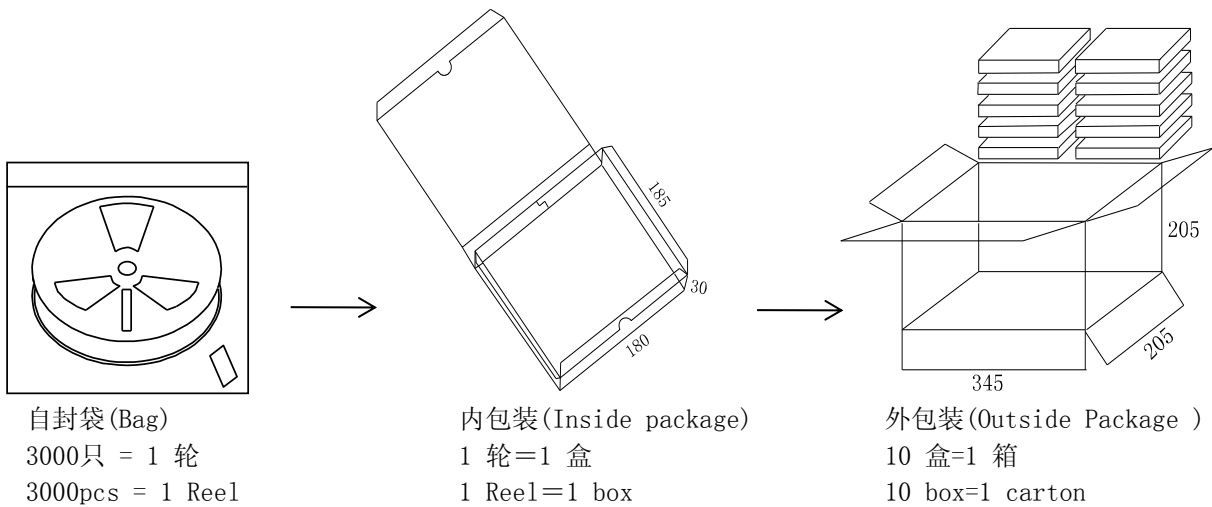

SHENZHEN SCTF ELECTRONICS CO. , LTD

DATE

Specification of quartz crystal oscillator
石英晶体振荡器规格书

Page:

2021-9-30

P/N: SX3M40.000A20F30TNN
Spec.NO.: SCTF2021X570

8

单击下面可查看定价，库存，交付和生命周期等信息

[>>SCTF\(星通时频\)](#)