



# STK3232

**Ambient Light Sensor and Proximity Sensor with I2C interface**

---

**Preliminary Datasheet**

Version – 0.9.0

**Sensortek Technology Corporation**

## 1. OVERVIEW

### Description

The STK3232 is an integrated ambient and infrared light to digital converter with I<sup>2</sup>C interface. This device provides not only ambient light sensing to allow robust backlight/display brightness control but also infrared sensing to allow proximity estimation featured with interrupt function.

For ambient light sensing, the STK3232 incorporates a photodiode, timing controller and ADC in a single chip. The excellent spectral response is designed to be close-to human eye. The STK3232 is suitable for detecting a wide range of light intensity environment.

For proximity sensing, the STK3232 also incorporates a photodiode, timing controller and ADC in the same chip. The spectral response of STK3232 is optimized for wavelength 940nm infrared light. The STK3232 provides programmable current setting to drive IR LED and employs a noise cancellation scheme to highly reject unwanted ambient IR noise.

The STK3232 has excellent temperature compensation, robust on-chip refresh rate setting without external components. Software shutdown mode control is provided for power saving application. The STK3232 operating voltage range is 1.7V to 3.0V.

### Feature

- Integrated ambient light sensor and proximity sensor in one package.

#### Proximity Sensor

- 16 bits resolution for proximity detection
- Built-in LED driver with flexible setting
  - LED turn-on time : 7 steps IT
  - LED current : 3.125 / 6.25 / 12.5 / 25 / 50 / 100 / 150 mA
- Flexible interrupt setting
  - Several interrupt modes meet application requirements.
  - Flag modes are included.
  - Intelligent persistence to speed up the response time : 1/2/4/16 times
- Low noise design
- High ambient light suppression

#### Ambient Light Sensor

- Convert ambient light intensity to 16-bit digital data format
- 3rd generation ambient light sensor which closes to human-eye response and suppress IR portion.
- Flexible digital settings
  - Integration time : 7 steps IT
- Flexible interrupt setting
  - Interrupt while out-of- window
  - Persistence : 1/2/4/8 times
- Clear channel for different light source compensation.

#### General

- Fully digital control with I<sup>2</sup>C interface
  - 1.7 ~ 3.6V I<sup>2</sup>C interface
- Low power design
  - Standby mode
  - Wait mode
- V<sub>DD</sub> wide operation voltage : 1.7~3.0V
- Excellent temperature compensation: -40 to 85°C
- Available package options: OLGA
  - STK3232 : 2.15 x 1.4 x 0.6 (mm)
- Lead-free package (RoHS compliant)
- Moisture Sensitivity Level 3

#### Applications

- Mobile Phone, Smart-phone, PDA

**2. FUNCTION BLOCK**

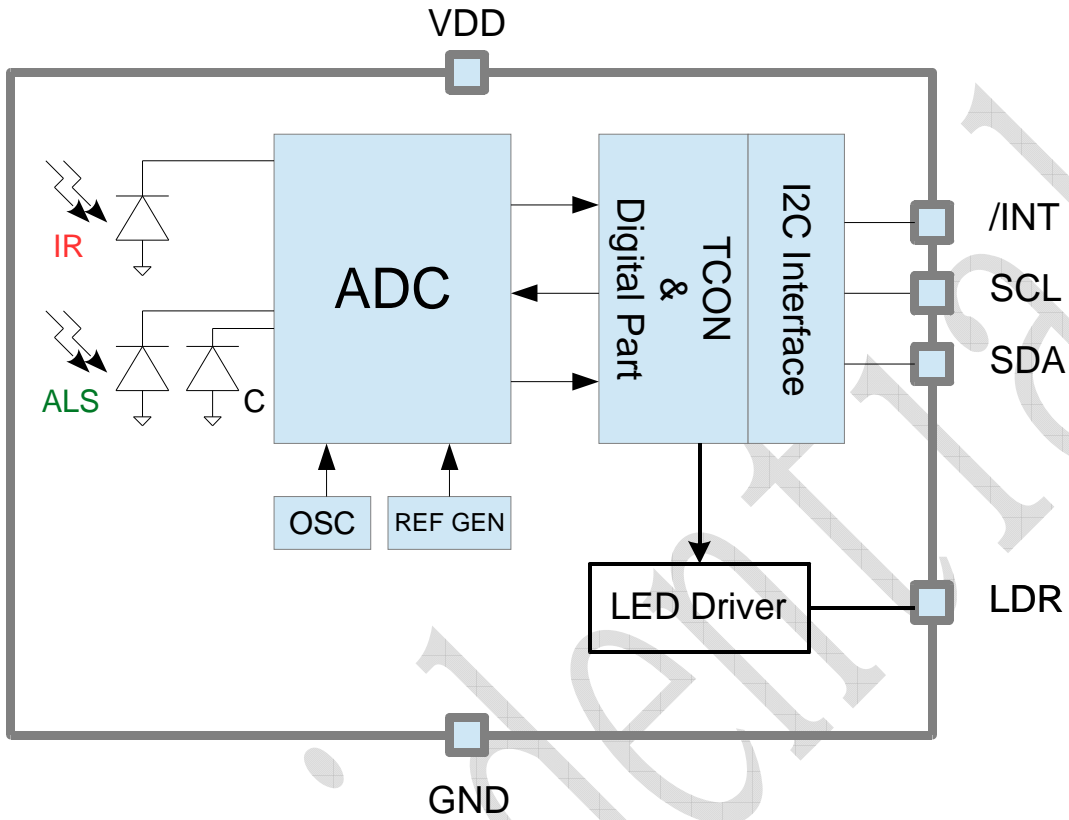

### 3. PINOUT DIAGRAM

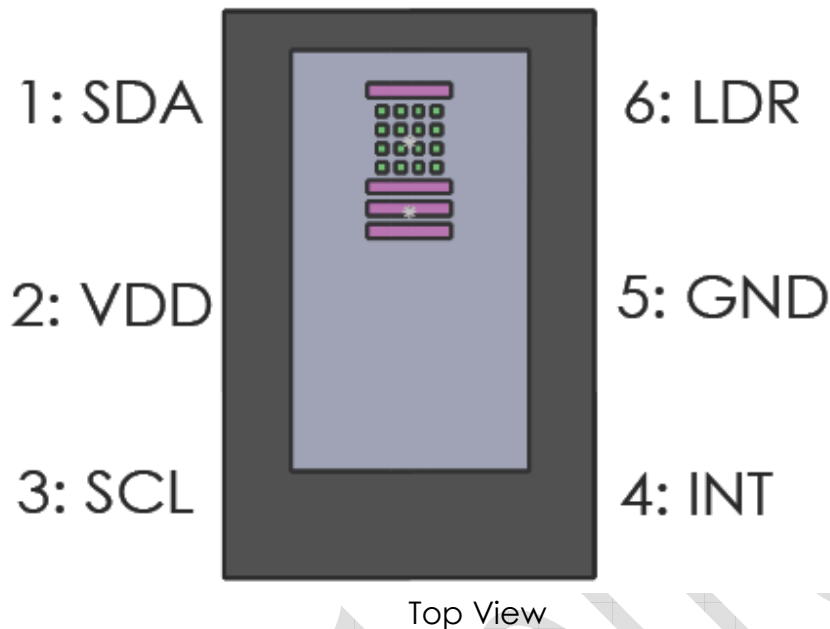

### 4. PIN DESCRIPTION

Pin No.	Pin Name	Dir.	Pin Function
1	SDA	B	I <sup>2</sup> C serial data line. (Open Drain)
2	VDD	PWR	Power supply: 1.7V to 3.0V.
3	SCL	I	I <sup>2</sup> C serial clock line.
4	/INT	O	Interrupt pin, LO for interrupt alarming. (Open Drain)
5	GND	GND	Ground. The thermal pad is also connected to the GND pin.
6	LDR	I	IR LED driver pin connecting to the cathode of the external IR LED. The sink current of the IR LED driver can be programmed through I <sup>2</sup> C or the external resistor.

Direction denotation:

O	Output	GND	Ground
I	Input	B	Bi-direction
PWR	Power	NC	Not Connect

## 5. ELECTRICAL SPECIFICATIONS

### Absolute Maximum Ratings

Symbol	Parameter	Min.	Typ.	Max.	Unit
V <sub>DD</sub>	Supply voltage	-0.3	—	3.6	V
V <sub>LEDA</sub>	Voltage of LED's anode	-0.3	—	4.7	V
V <sub>LDR</sub>	Voltage of LDR			3.6	V
T <sub>a</sub>	Operation temperature	-40	—	85	°C
T <sub>s</sub>	Storage temperature	-40	—	85	°C

NOTE: All voltages are measured with respect to GND

### Recommended Operating Conditions

Symbol	Parameter	Min.	Typ.	Max.	Unit
V <sub>DD</sub>	Supply voltage	1.7	—	3.0	V
V <sub>LEDA</sub>	Voltage of LED's anode	2.8	—	4.6	V
f <sub>I2C</sub>	Clock frequency of I <sup>2</sup> C	—	—	400	KHz
T <sub>a</sub>	Operation temperature	-40	—	85	°C

NOTE: All voltages are measured with respect to GND

Symbol	Parameter	Max.	Unit
ESD	Electrostatic discharge protection	2 (HBM)	kV
		200 (MM)	V
		100 (Latch Up)	mA

NOTE: All voltages are measured with respect to GND

## 5.1 Electrical and Optical Characteristics

$V_{DD} = V_{LED} = 2.8V$ , under room temperature 25°C (unless otherwise noted)

Symbol	Parameter	Condition	Min.	Typ.	Max.	Unit
Operation Characteristics						
$I_{ALS}$	ALS only supply current	Note1,2		TBD		$\mu A$
$I_{PS}$	PS only supply current	Note1,2		TBD		$\mu A$
$I_{WAIT}$	Supply current at wait state	Note1,2		TBD		$\mu A$
$I_{SD}$	Shutdown current	Note1,2		TBD		$\mu A$
$V_{IH}$	Logic high, I <sup>2</sup> C	Note6	1.3		$V_{DD}$	V
$V_{IL}$	Logic low, I <sup>2</sup> C	Note7	—		0.4	V
ALS Characteristics						
$\lambda_{p1}$	Peak sensitivity wavelength for ALS			550		nm
$ALS_{FSCNT}$	Full scale ALS counts				65535	counts
$ALS_{DARK}$	ALS dark offset	Note2,3,4		0	TBD	counts
$ALS_{SENSE}$	ALS sensing tolerance	Note2,3			TBD	%
Proximity Characteristics						
$\lambda_{p2}$	High sensitivity wavelength range for PS		800		1000	nm
$PS_{FSCNT}$	Full scale PS counts				65535	counts
$I_{LED_{SINK}}$	LED sink current	IRDR_LED[2:0] Note5				
		000		3.125		mA
		001		6.25		mA
		010		12.5		mA
		011		25		mA
		100		50		mA
		101		100		mA
		110		150		mA
$AMB_{SUPP}$	Ambient Light Suppression	Note8			TBD	Lux

Note 1 : No LED operation.

Note 2 :  $GAIN\_ALS[1:0] = 2'b00$ ,  $.IT\_ALS[3:0] = 4'b0010$ ,  $GAIN\_PS[1:0] = 2'b00$ ,  $.IT\_PS[3:0] = 4'b0000$ .

Note 3 : White LED parallel light source.

Note 4 :  $E_{ambient} = 0$  Lux.

Note 5 : The voltage of LDR pin is fixed at 1V.

Note 6 : I<sup>2</sup>C logical high voltage level is specified as worst-case condition when all of the recommended operation supply voltages ( $V_{DD}$ ) are taken into consideration. The logical high level is different when different supply voltage is applied.

Note 7 : I<sup>2</sup>C logical low voltage level is specified as worst-case condition when all of the recommended operation supply voltages ( $V_{DD}$ ) are taken into consideration. The logical low level is different when different supply voltage is applied.

Note 8 : Sunlight environment.

## 5.2 Timing Chart

### Characteristics of the SDA and SCL I/O

Symbol	Parameter	Standard Mode		Fast Mode		Unit
		Min.	Max.	Min.	Max.	
$f_{SCLK}$	SCL clock frequency	10	100	10	400	KHz
$t_{HDSTA}$	Hold time after (repeated) start condition. After this period, the first clock is generated	4.0	—	0.6	—	$\mu$ s
$t_{LOW}$	LOW period of the SCL clock	4.7	—	1.3	—	$\mu$ s
$t_{HIGH}$	HIGH period of the SCL clock	4.0	—	0.6	—	$\mu$ s
$t_{SUSTA}$	Set-up time for a repeated START condition	4.7	—	0.6	—	$\mu$ s
$t_{HDDAT}$	Data hold time	0	—	0	—	ns
$t_{SUDAT}$	Data set-up time	250	—	100	—	ns
$t_r$	Rise time of both SDA and SCL signals	—	1000	—	300	ns
$t_f$	Fall time of both SDA and SCL signals	—	300	— <td 300	ns	
$t_{SUSTO}$	Set-up time for STOP condition	4.0	—	0.6	—	$\mu$ s
$t_{BUF}$	Bus free time between a STOP and START condition	4.7	—	1.3	—	$\mu$ s

Note 1:  $f_{SCLK}$  is the  $(t_{SCLK})^{-1}$ .

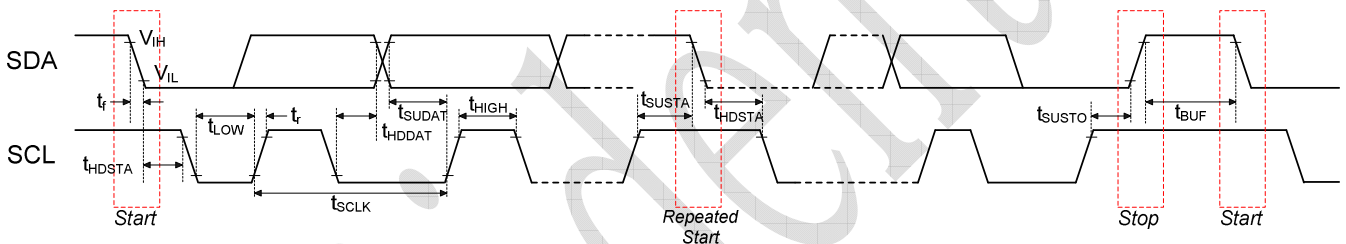

Timing Chart of the SDA and SCL

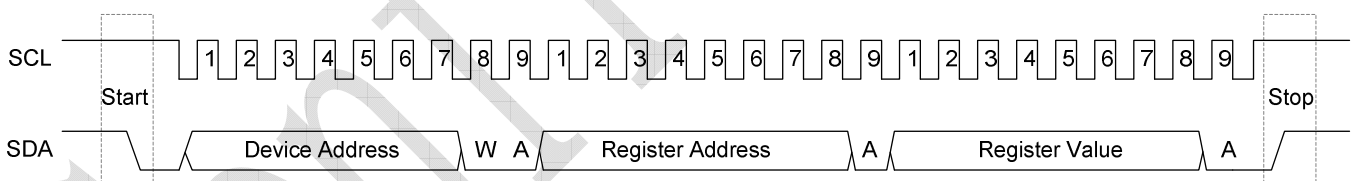

Write Command

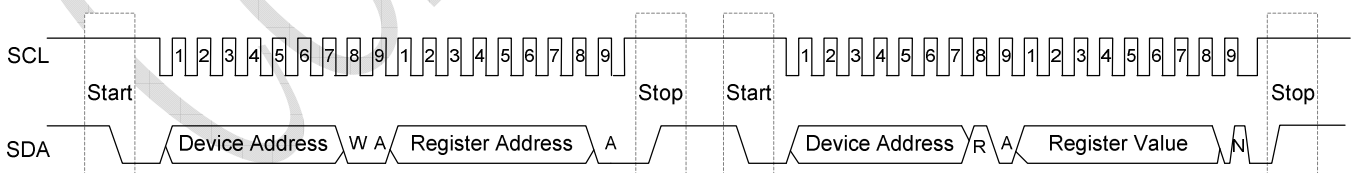

Read Data

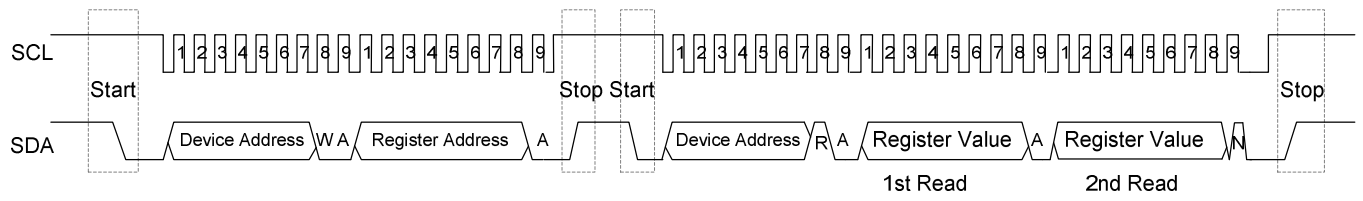

**Sequential Read Data**

Confidential



## 6. FUNCTION DESCRIPTION

### 6.1 Digital Interface

STK3232 contains eight-bit registers accessed via the I<sup>2</sup>C bus. All operations can be controlled by the command register. The simple command structure makes user easy to program the operation setting and latch the output data from STK3232. Section 5.2 Timing chart displays the STK3232 I<sup>2</sup>C command format for reading and writing operation between host and STK3232.

STK3232 provides fixed I<sup>2</sup>C slave address of 0x47 using 7 bit addressing protocol.

Slave Address	R/W Command Bit	OPERATION
0x47	0	Write Command to STK3232
(followed by the R/W bit)	1	Read Data from STK3232

## 6.2 System Operation

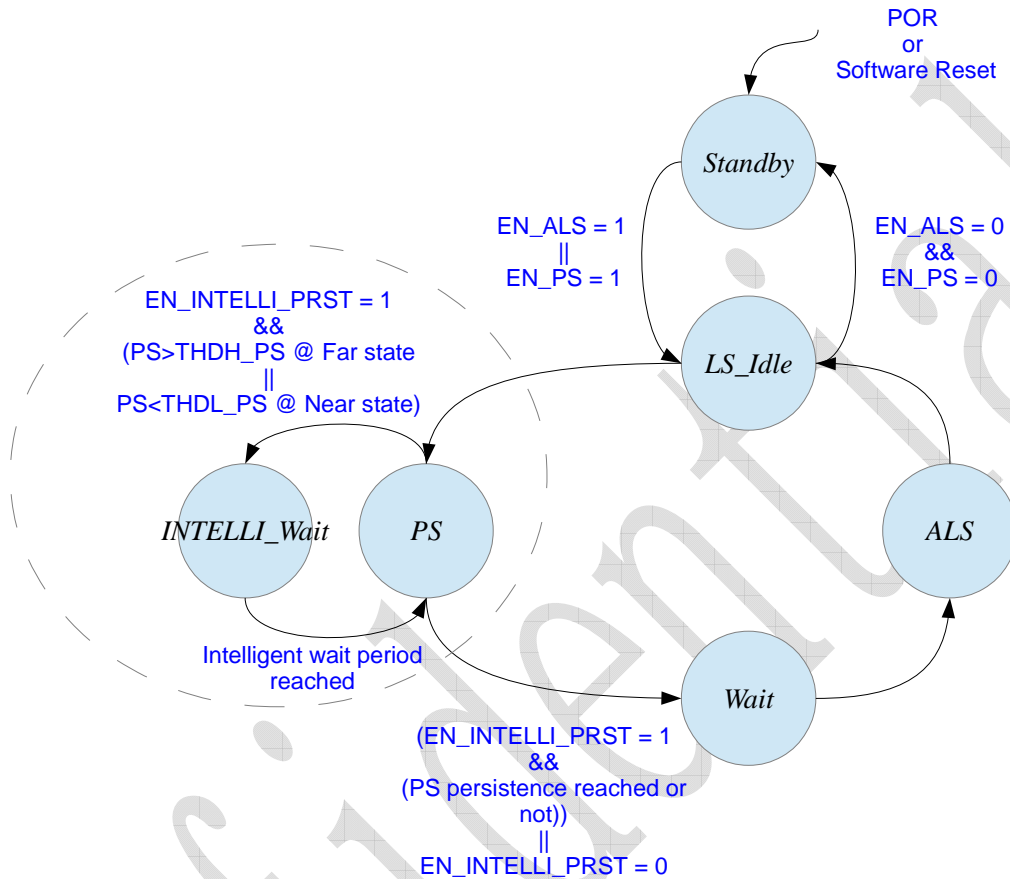

## 6.3 ALS Operation

### 6.3.1 ALS General Operation

The related ALS control bits are summarized below.

#### ALS Control Bits

General Control	
EN_ALS	Enable ALS sensing function
IT_ALS[3:0]	ALS integration time
GAIN_ALS[1:0]	ALS gain control
PRST_ALS[1:0]	ALS persistence number
GAIN_C[1:0]	Clear channel gain control
ALS Interrupt Control	
EN_ALS_INT	Enable ALS function interrupt
EN_ALS_DR_INT	Enable ALS data ready interrupt
THDH_ALS[15:0]	ALS out-of-windows high threshold
THDL_ALS[15:0]	ALS out-of-windows low threshold

**ALS Data/Status Bits**

<b>Data</b>	
DATA_ALS[15:0]	16-bits ALS channel raw data
DATA_C[15:0]	16-bits Clear channel raw data
<b>Status</b>	
FLG_ALS_DR	Indicate the ALS data ready event
FLG_ALS_INT	Indicate the Green channel out-of-windows event

STK3232 uses the coated photodiode array to measure the Lux of the incoming light and also an un-filtered clear photodiode array to improve the ALS sensing accuracy.

The ALS sensing function is enabled by the EN\_ALS bit and the gain control bit GAIN\_ALS[1:0]/GAIN\_C[1:0] and IT period IT\_ALS[3:0] shall be set before the EN\_ALS.

The FLG\_ALS\_DR bit shall be asserted every ADC conversion cycle complete and shall be cleared automatically after one of the DATA\_ALS[15:0]/DATA\_C[15:0] is be read out through I<sup>2</sup>C.

The ALS/C data are 16-bit output and are stored in two bytes register. Higher byte register must be read first than lower byte. Data reading word protection is implemented to make sure the conversion data within the same conversion cycle could be read correctly. When the higher byte register is read, the lower 8-bit data will be stored into a shadow register which is read by the following sequential read or another single read to the lower byte register.

### 6.3.2 ALS Interrupt Description

#### **ALS Out-of-Windows Interrupt**

STK3232 provides the ALS data out-of-windows interrupt. Once the EN\_ALS\_INT is set to 1, then the STK3232 shall issue an ALS interrupt and assert the FLG\_ALS\_INT bit if the ALS data DATA\_ALS[15:0] are outside the user's programmed window defined by THDH\_ALS[15:0] and THDL\_ALS[15:0]. The FLG\_ALS\_INT shall be cleared by write the bit 0 and shall be reset to 0 if POR/SWRst or EN\_ALS = 0. Clear the EN\_ALS\_INT will also clear the FLG\_ALS\_INT bit to 0.

ALS persistence numbers PRST\_ALS[1:0] is used to avoid the false alarm of ALS out-of-windows event due to environment noise. If ALS persistence is set larger than 1, then the ALS out-of-windows interrupt will not be issued until continuous persistence numbers of ADC conversion results outside the defined windows.

#### **ALS Data Ready Interrupt**

STK3232 also provides the ALS data ready interrupt. Once the EN\_ALS\_DR\_INT is set to 1, then the STK3232 shall issue an ALS data ready interrupt every ADC conversion cycle and assert the FLG\_ALS\_DR bit. The FLG\_ALS\_DR shall be cleared automatically after any one of the DATA\_R/G/B/C[15:0] is be read out through I<sup>2</sup>C and shall be reset to 0 if POR/SWRst or EN\_ALS = 0. Clear the EN\_ALS\_DR\_INT will not influence the FLG\_ALS\_DR status.

## 6.4 PS Operation

### 6.4.1 PS General Operation

The related PS control bits are summarized below.

#### PS Control Bits

<b>General Control</b>	
EN_PS	Enable PS function
EN_INTELLI_PRST	Enable PS intelligent persistence
IT_PS[3:0]	PS integration time
GAIN_PS[1:0]	PS gain control
PRST_PS[1:0]	PS persistence number
DATA_PS_OFFSET[15:0]	PS digital offset cancel
INTELLI_WAIT_PS[6:0]	PS intelligent persistence wait period
<b>LED Control</b>	
IRDR_LED[2:0]	Choose LED driving current
<b>PS Interrupt Control</b>	
PS_INT_MODE[2:0]	Choose PS interrupt mode.
EN_PS_INT	Enable PS function interrupt
EN_PS_DR_INT	Enable PS data ready interrupt
THDH_PS[15:0]	PS near-far detect high threshold
THDL_PS[15:0]	PS near-far detect low threshold

#### PS Data/Status Bits

<b>Data</b>	
DATA_PS[15:0]	16-bits PS raw data
<b>Status</b>	
FLG_NF	Indicate the current object near/far state
FLG_PS_INT	Indicate the object near/far state changed event
FLG_PS_DR	Indicate the PS data ready event

The proximity function is used for object detection by IR-sensitivity photodiode detection of reflected IR energy emitted by the built-in IR LED.

The DATA\_PS[15:0] will be the ADC output subtract offset data defined in DATA\_PS\_OFFSET[15:0]. The PS data are 16-bit output and are stored in two bytes register. Higher byte register must be read first than lower byte. Data reading word protection is implemented to make sure the conversion data within the same conversion cycle could be read correctly. When the higher byte register is read, the lower 8-bit data will be stored into a shadow register which is read by the following sequential read or another single read to the lower byte register.

The FLG\_NF is used to indicate the current object is in near or far state and persistence is also applied to this flag if PRST\_PS > 1.

The FLG\_PS\_DR bit shall be asserted every ADC conversion cycle complete and shall be cleared automatically after the DATA\_PS[15:0] is be read out through I<sup>2</sup>C.

IRDR\_LED[2:0] is used to choose different LED constant driving current. STK3232 has 8 different LED current

levels 3.125/6.25/12.5/25/50/100/150 mA.

#### 6.4.2 PS Interrupt Description

The EN\_PS\_INT[0] register is used to control PS interrupt function for enable or disable  
 The PS\_NF\_MODE[1] register is used to select how STK3630 reports the object near/far state to application.  
 The PS\_INT\_MODE[2] register is PS interrupt modes for near/far state change are described as below.

##### **PS INT Function (EN\_PS\_INT[0] = 1'b0) & PS Near/Far Flag Mode (PS\_NF\_Mode[1] = 1'b0)**

If EN\_PS\_INT[0] is set to 1'b0, then the polling mode is used and the INT pin is non-active when near/far event detected. In this mode, the INT output level is fixed to pull-high and the FLG\_PS\_INT will never be asserted. The application simply polls the FLG\_NF to check the object in near or far state.

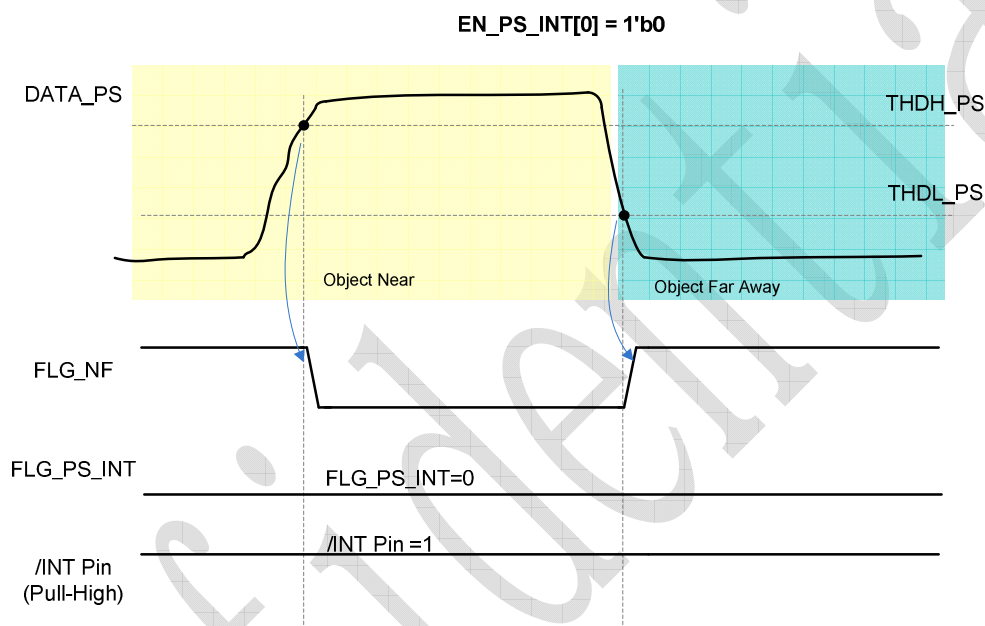

##### **PS INT Function (EN\_PS\_INT[0] = 1'b1) & PS Near/Far Flag Mode (PS\_NF\_Mode[1] = 1'b0)**

The INT pin is treated as interrupt signal. The FLG\_NF is used to indicate whether the object is in near or far state. The STK3232 is default in object far state and the FLG\_NF = 1. Once the object moving close to the STK3232 and PS code exceed the high threshold THDH\_PS, STK3232 will switch to object near state and the FLG\_NF is cleared to 0. STK3232 will issue a PS interrupt to inform the object near/far state changed and also set the FLG\_PS\_INT to 1. If the object move far away from the STK3232 and PS code lower than the low threshold THDL\_PS, STK3232 will switch to object far state and the FLG\_NF is set to 1. STK3232 will also issue a PS interrupt to inform and set FLG\_PS\_INT. The FLG\_PS\_INT shall be cleared by write the bit 0 and shall be reset to 0 if POR/SWRst or EN\_PS = 0. The FLG\_NF shall be reset to 1 if POR/SWRst or EN\_PS = 0. Change the PS\_MODE will also clear the FLG\_PS\_INT to 0, but keep the current PS code and FLG\_NF state.

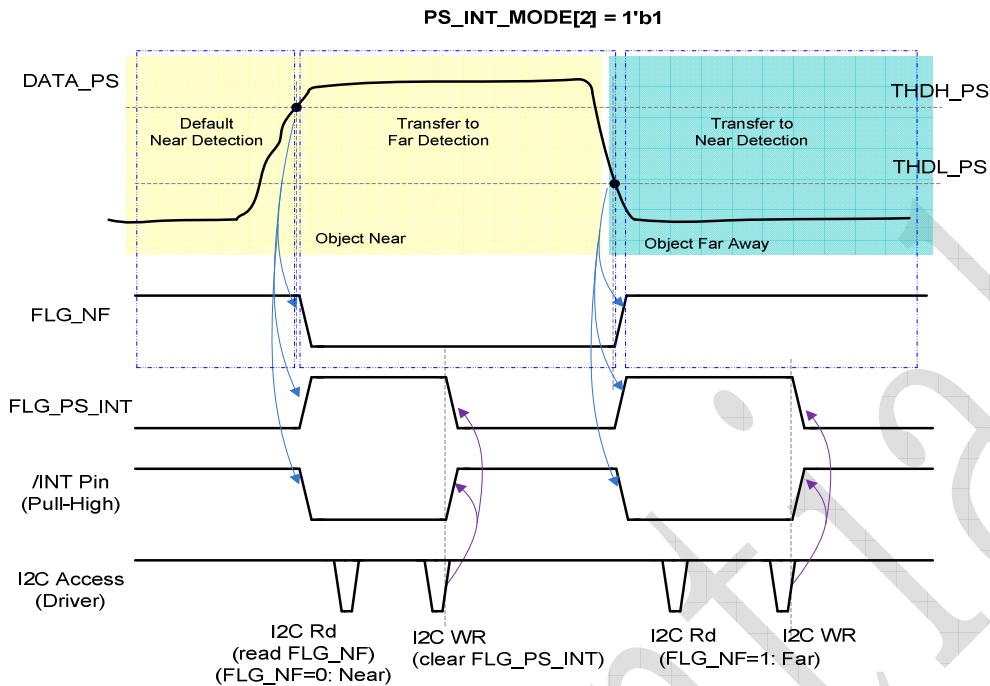

PS persistence numbers  $PRST\_PS[1:0]$  is used to avoid the false alarm of PS interrupt event due to environment noise. If PS persistence is set larger than 1, then the PS interrupt will not be issued until continuous persistence numbers of ADC conversion results meet the interrupt condition describe above.

STK3232 also provides intelligent persistence to speed up the response time and can be enabled by set  $EN\_INTELLI\_PRST$  to 1. Once the PS signal is exceed the high threshold when object in far state or lower than low threshold when in near state,  $EN\_INTELLI\_PRST = 1$  and the PS persistence number  $PRST\_PS[1:0]$  large than 1, the STK3232 will enter the  $PS\_INTELLI\_WAIT$  PS function sub-state and use a shorter  $INTELLI\_WAIT\_PS$  period to perform the PS persistence check. This is used to shorten the PS response time and also avoid the flicker noise influence when choosing the right wait period. The STK3232 shall return to the normal operation state loop no matter what PS persistence success or fail.

For example:

(1)  $PRST\_PS[1:0] = 2'b01$  (x2),  $EN\_ALS = 1$ ,  $EN\_PS = 1$ ,  $EN\_WAIT = 1$ ,  $EN\_INTELLIGENT\_PRST = 0$

(2)  $PRST\_PS[1:0] = 2'b01$  (x2),  $EN\_ALS = 1$ ,  $EN\_PS = 1$ ,  $EN\_WAIT = 1$ ,  $EN\_INTELLIGENT\_PRST = 1$

(3)  $PRST\_PS[1:0] = 2'b10$  (x4),  $EN\_ALS = 1$ ,  $EN\_PS = 1$ ,  $EN\_WAIT = 1$ ,  $EN\_INTELLIGENT\_PRST = 1$  and fail to issue interrupt (no continue persistence numbers of PS ADC conversion results is out of threshold),

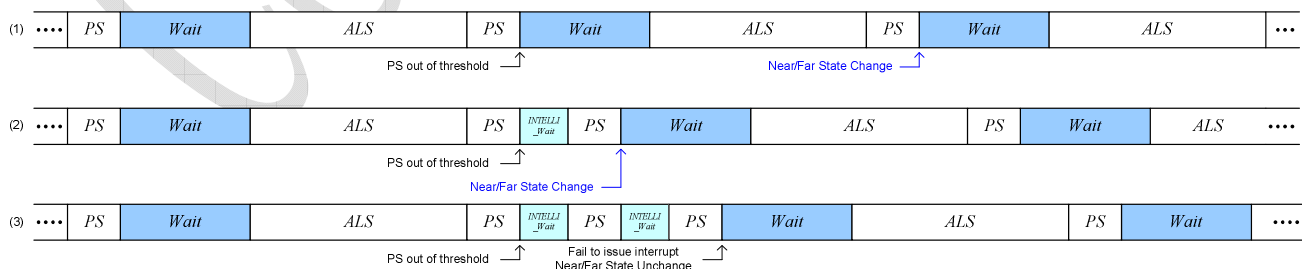

### **PS INT Function (EN\_PS\_INT[0] = 1'b1) & PS Near/Far Flag Mode (PS\_NF\_Mode[1] = 1'b1)**

If PS\_NF\_MODE[1] = 1'b1, then the polling mode is used and the INT pin is treated as a near/far flag signal, not an interrupt signal. In this mode, the INT output level is same with the FLG\_NF signal level and the FLG\_PS\_INT will never be asserted. The application simply polls the INT level (high or low) to check the object in near or far state. INT Pin is only from PS FLG\_NF, and the ALS interrupt, Invalid PS interrupt is ignored.

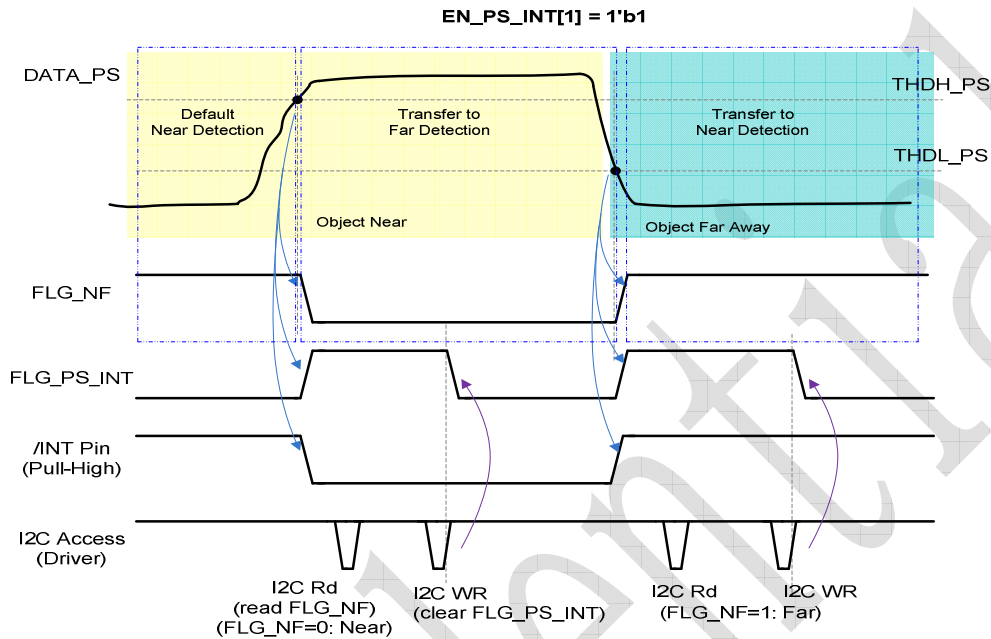

### **PS Data Ready Interrupt**

STK3232 provides the PS data ready interrupt. Once the EN\_PS\_DR\_INT is set to 1, then the STK3232 shall issue a PS data ready interrupt every ADC conversion cycle and assert the FLG\_PS\_DR bit. The FLG\_PS\_DR shall be cleared automatically after the DATA\_PS[15:0] is be read out through I2C and shall be reset to 0 if POR/SWRst or EN\_PS = 0. Clear the EN\_PS\_DR\_INT will not influence the FLG\_PS\_DR status.

## 6.5 Wait State Operation

### 6.5.1 Wait State General Operation

The related Wait control bits are summarized below.

<b>Wait Control Bits</b>	
<b>General Control</b>	
EN_WAIT	Enable Wait state
WAIT[7:0]	Wait period

Wait state is used for power saving



## 7. CONTROL REGISTER MAP

ADDR	REG NAME	BIT								Default
		7	6	5	4	3	2	1	0	
0x00	<a href="#">STATE</a>				EN_CTAU TOK	EN_INTELLI PRST	EN_WAIT	EN_ALS	EN_PS	0x00
0x01	<a href="#">PSCTRL</a>	PRST_PS[1:0]		GAIN_PS[1:0]		IT_PS[3:0]				0x00
0x02	<a href="#">ALSCTRL1</a>	PRST_ALS[1:0]		GAIN_ALS[1:0]		IT_ALS[3:0]				0x02
0x03	<a href="#">LEDCTRL</a>	IRDR_LED[2:0]						EN_CTIRFC	EN_CTIR	0x60
0x04	<a href="#">INTCTRL1</a>	INT_CTRL		EN_INVALI D_PS_INT		EN_ALS_I NT	PS_INT_M ODE	PS_NF_MO DE	EN_PS_I NT	0x00
0x05	<a href="#">WAIT</a>	WAIT[7:0]								0x00
0x06	<a href="#">THDH1_PS</a>	THDH_PS[15:8]								0xFF
0x07	<a href="#">THDH2_PS</a>	THDH_PS[7:0]								0xFF
0x08	<a href="#">THDL1_PS</a>	THDL_PS[15:8]								0x00
0x09	<a href="#">THDL2_PS</a>	THDL_PS[7:0]								0x00
0x0A	<a href="#">THDH1_ALS</a>	THDH_ALS[15:8]								0xFF
0x0B	<a href="#">THDH2_ALS</a>	THDH_ALS[7:0]								0xFF
0x0C	<a href="#">THDL1_ALS</a>	THDL_ALS[15:8]								0x00
0x0D	<a href="#">THDL2_ALS</a>	THDL_ALS[7:0]								0x00
0x10	<a href="#">FLAG</a>	FLG_ALS_ DR	FLG_PS_D R	FLG_ALS_I NT	FLG_PS_I NT		FLG_ALS_S AT	FLG_INVALI D_PS_INT	FLG_NF	0x01
0x11	<a href="#">DATA1_PS</a>	DATA_PS[15:8]								0x00
0x12	<a href="#">DATA2_PS</a>	DATA_PS[7:0]								0x00
0x13	<a href="#">DATA1_ALS</a>	DATA_ALS[15:8]								0x00
0x14	<a href="#">DATA2_ALS</a>	DATA_ALS[7:0]								0x00
0x1B	<a href="#">DATA1_C</a>	DATA_C[15:8]								0x00
0x1C	<a href="#">DATA2_C</a>	DATA_C[7:0]								0x00
0x1D	<a href="#">DATA1_PS_OFFSET</a>	DATA_PS_OFFSET[15:8]								0x00
0x1E	<a href="#">DATA2_PS_OFFSET</a>	DATA_PS_OFFSET[7:0]								0x00
0x20	<a href="#">DATA_CTIR1</a>	DATA_CTIR1[7:0]								0x00
0x21	<a href="#">DATA_CTIR2</a>	DATA_CTIR2[7:0]								0x00
0x22	<a href="#">DATA_CTIR3</a>	DATA_CTIR3[7:0]								0x00
0x23	<a href="#">DATA_CTIR4</a>	DATA_CTIR4[7:0]								0x00
0x3E	<a href="#">PDT_ID</a>	PDT_ID[7:0]								TBD
0x3F	<a href="#">Reserved</a>	Reserved								
0x4E	<a href="#">ALSCTRL2</a>			GAIN_C[1:0]						0x00
0x4F	<a href="#">INTELLI_WAIT_PS</a>	INTELLI_WAIT_PS[6:0]								0x00
0x80	<a href="#">SOFT RESET</a>	Write any to soft reset								
0xA5	<a href="#">INTCTRL2</a>							EN_ALS_DR _INT	EN_PS_ DR_INT	0x00

**STATE Register (0x00)**

Bit	7	6	5	4	3	2	1	0
ITEM				EN_CTAU TOK	EN_INTEL LI_WAIT	EN_WAIT	EN_ALS	EN_PS
Access				R/W	R/W	R/W	R/W	R/W
Default				0	0	0	0	0

Bit	ITEM	Description
0	EN_PS	Enable the PS function. 0 : Disable 1 : Enable
1	EN_ALS	Enable the ALS/C function. 0 : Disable 1 : Enable
2	EN_WAIT	Enable the Wait state. 0 : Disable 1 : Enable
3	EN_INTELLI_PRST	Enable the intelligent persistence function. 0 : Disable 1 : Enable
4	EN_CTAUTOK	Enable the CTAUTOK function. 0 : Disable 1 : Enable

**PSCTRL Register (0x01)**

Bit	7	6	5	4	3	2	1	0
ITEM	PRST_PS[1:0]		GAIN_PS[1:0]		IT_PS[3:0]			
Access	R/W		R/W		R/W			
Default	2'b00		2'b00		4'b0000			

Bit	ITEM	Description																
3:0	IT_PS[3:0]	PS integration time. <table border="1"> <tr> <td>4'b0000</td> <td>96 us</td> </tr> <tr> <td>4'b0001</td> <td>192 us</td> </tr> <tr> <td>4'b0010</td> <td>384 us</td> </tr> <tr> <td>4'b0011</td> <td>768 us</td> </tr> <tr> <td>4'b0100</td> <td>1.54 ms</td> </tr> <tr> <td>4'b0101</td> <td>3.07 ms</td> </tr> <tr> <td>4'b0110</td> <td>6.14 ms</td> </tr> <tr> <td>others</td> <td>Reserved</td> </tr> </table>	4'b0000	96 us	4'b0001	192 us	4'b0010	384 us	4'b0011	768 us	4'b0100	1.54 ms	4'b0101	3.07 ms	4'b0110	6.14 ms	others	Reserved
4'b0000	96 us																	
4'b0001	192 us																	
4'b0010	384 us																	
4'b0011	768 us																	
4'b0100	1.54 ms																	
4'b0101	3.07 ms																	
4'b0110	6.14 ms																	
others	Reserved																	
5:4	GAIN_PS[1:0]	PS gain setting. <table border="1"> <tr> <td>2'b00</td> <td>x 1 times</td> </tr> <tr> <td>2'b01</td> <td>x 2 times</td> </tr> <tr> <td>2'b10</td> <td>x 4 times</td> </tr> <tr> <td>2'b11</td> <td>x 8 times</td> </tr> </table>	2'b00	x 1 times	2'b01	x 2 times	2'b10	x 4 times	2'b11	x 8 times								
2'b00	x 1 times																	
2'b01	x 2 times																	
2'b10	x 4 times																	
2'b11	x 8 times																	

7:6	PRST_PS[1:0]	PS persistence setting. The PS has an interrupt persistence filter. The persistence filter allows user to specify the number of consecutive out-of-threshold PS occurrences before an interrupt is triggered.	
		2'b00	x 1 times
		2'b01	x 2 times
		2'b10	x 4 times
		2'b11	x 16 times

### ALSCTRL1 Register (0x02)

Bit	7	6	5	4	3	2	1	0
ITEM	PRST_ALS[1:0]		GAIN_ALS[1:0]		IT_ALS[3:0]			
Access	R/W		R/W		R/W			
Default	2'b00		2'b00		4'b0010			

Bit	ITEM	Description	
3:0	IT_ALS[3:0]	ALS integration time.	
		4'b0000	25 ms
		4'b0001	50 ms
		4'b0010	100 ms
		4'b0011	200 ms
		4'b0100	400 ms
		4'b0101	800 ms
		4'b0110	1600 ms
		others	Reserved
5:4	GAIN_ALS[1:0]	ALS gain setting. GAIN_ALS[1:0] is used to control of the ALS channel signal gain. The Clear channel is controlled by GAIN_C[1:0].	
		2'b00	x 1 times
		2'b01	x 4 times
		2'b10	x 16 times
		2'b11	x 64 times
7:6	PRST_ALS[1:0]	ALS persistence setting. The ALS has an interrupt persistence filter. The persistence filter allows user to specify the number of consecutive out-of-windows ALS occurrences before an interrupt is triggered.	
		2'b00	x 1 times
		2'b01	x 2 times
		2'b10	x 4 times
		2'b11	x 8 times

### LEDCTRL Register (0x03)

Bit	7	6	5	4	3	2	1	0
ITEM	IRDR_LED[2:0]						EN_CTIRFC	EN_CTIR
Access	R/W						R/W	R/W
Default	3'b101						0	0

Bit	ITEM	Description																
7:5	IRDR_LED[2:0]	LED constant current setting. The STK3232 provides different sinking ability for IRLED through setting IRDR. <table border="1" data-bbox="507 689 1072 922"> <thead> <tr> <th>3'b</th> <th>Current Sink</th> </tr> </thead> <tbody> <tr> <td>000</td> <td>3.125 mA current sink</td> </tr> <tr> <td>001</td> <td>6.25 mA current sink</td> </tr> <tr> <td>010</td> <td>12.5 mA current sink</td> </tr> <tr> <td>011</td> <td>25 mA current sink</td> </tr> <tr> <td>100</td> <td>50 mA current sink</td> </tr> <tr style="background-color: #c8e6c9;"> <td>101</td> <td>100 mA current sink</td> </tr> <tr> <td>110</td> <td>150 mA current sink</td> </tr> </tbody> </table>	3'b	Current Sink	000	3.125 mA current sink	001	6.25 mA current sink	010	12.5 mA current sink	011	25 mA current sink	100	50 mA current sink	101	100 mA current sink	110	150 mA current sink
3'b	Current Sink																	
000	3.125 mA current sink																	
001	6.25 mA current sink																	
010	12.5 mA current sink																	
011	25 mA current sink																	
100	50 mA current sink																	
101	100 mA current sink																	
110	150 mA current sink																	
1	EN_CTIRFC	If EN_CTIR and EN_CTAUTOK always set to 1. 0 : CTIR is auto mode. 1 : CTIR is manual mode. (To set DATA_CTIRn data can reduce sunlight effect.) <table border="1" data-bbox="507 1070 1091 1200"> <thead> <tr> <th>mode</th> <th>EN_CTAUTOK</th> <th>EN_CTIRFC</th> <th>EN_CTIR</th> </tr> </thead> <tbody> <tr> <td>Auto</td> <td>1</td> <td>0</td> <td>1</td> </tr> <tr> <td>Manual</td> <td>0</td> <td>1</td> <td>1</td> </tr> </tbody> </table>	mode	EN_CTAUTOK	EN_CTIRFC	EN_CTIR	Auto	1	0	1	Manual	0	1	1				
mode	EN_CTAUTOK	EN_CTIRFC	EN_CTIR															
Auto	1	0	1															
Manual	0	1	1															
0	EN_CTIR	Enable the CTIR function. 0 : Disable 1 : Enable																

### INTCTRL1 Register (0x04)

Bit	7	6	5	4	3	2	1	0
ITEM	INT_CTRL		EN_INVALID_PS_INT		EN_ALS_INT	PS_INT_MODE[2:0]		
Access	R/W		R/W		R/W	R/W		
Default	0		0		0	3'b000		

Bit	ITEM	Description
2:0	PS_INT_MODE[2:0]	Select PS interrupt mode. Refer to the PS interrupt description.
3	EN_ALS_INT	Enable the ALS out-of-windows interrupt. 0 : Disable 1 : Enable
5	EN_INVALID_PS_INT	Enable the Invalid PS interrupt. 0 : Disable 1 : Enable
7	INT_CTRL	0 : Set /INT pin low if FLG_ALS_INT or FLG_ALS_DR or FLG_PS_INT or FLG_PS_DR high (logical OR)

		1 : Set /INT pin low if FLG_ALS_INT and FLG_ALS_DR and FLG_PS_INT and FLG_PS_DR high (logical AND)
--	--	--

### WAIT Register (0x05)

Bit	7	6	5	4	3	2	1	0
ITEM	WAIT[7:0]							
Access	R/W							
Default	8'b00000000							

Bit	ITEM	Description
7:0	WAIT[7:0]	PS/GS wait state period. wait period = (WAIT[7:0] + 1) * 1.54 ms

### THDH1 PS Register (0x06)

Bit	7	6	5	4	3	2	1	0
ITEM	THDH_PS[15:8]							
Access	R/W							
Default	8'b11111111							

### THDH2 PS Register (0x07)

Bit	7	6	5	4	3	2	1	0
ITEM	THDH_PS[7:0]							
Access	R/W							
Default	8'b11111111							

### THDL1 PS Register (0x08)

Bit	7	6	5	4	3	2	1	0
ITEM	THDL_PS[15:8]							
Access	R/W							
Default	8'b00000000							

### THDL2 PS Register (0x09)

Bit	7	6	5	4	3	2	1	0
ITEM	THDL_PS[7:0]							
Access	R/W							
Default	8'b00000000							

Bit	ITEM	Description
15:0	THDH_PS[15:0]	PS high threshold.
15:0	THDL_PS[15:0]	PS low threshold.

### THDH1 ALS Register (0x0A)

Bit	7	6	5	4	3	2	1	0
ITEM	THDH_ALS[15:8]							
Access	R/W							
Default	8'b11111111							

### THDH2 ALS Register (0x0B)

Bit	7	6	5	4	3	2	1	0
ITEM	THDH_ALS[7:0]							
Access	R/W							
Default	8'b11111111							

### THDL1 ALS Register (0x0C)

Bit	7	6	5	4	3	2	1	0
ITEM	THDL_ALS[15:8]							
Access	R/W							
Default	8'b00000000							

### THDL2 ALS Register (0x0D)

Bit	7	6	5	4	3	2	1	0
ITEM	THDL_ALS[7:0]							
Access	R/W							
Default	8'b00000000							

Bit	ITEM	Description
15:0	THDH_ALS[15:0]	ALS high threshold.
15:0	THDL_ALS[15:0]	ALS low threshold.

### FLAG Register (0x10)

Bit	7	6	5	4	3	2	1	0
ITEM	FLG_ALS_DR	FLG_PS_DR	FLG_ALS_INT	FLG_PS_INT		FLG_ALS_SAT	FLG_INVALID_PS_INT	FLG_NF
Access	R/W	R/W	R/W	R/W		RO	R/W	RO
Default	0	0	0	0		0	0	1

Bit	ITEM	Description
0	FLG_NF	Object near/far flag. Default FLG_NF = 1, object in far state. 0 : Object in near state 1 : Object in far state

1	FLG_INVALID_PS_INT	Indicate if interrupt event is related to INVALID_PS_INT. Write bit 0 to clear. 0 : No INVALID_PS_INT event 1 : INVALID_PS_INT event
2	FLG_ALS_SAT	Indicate the ALS channel circuit saturation. 0 : No ALS channel circuit saturation, the data is valid. 1 : ALS channel circuit saturation, the data is not valid.
4	FLG_PS_INT	Indicate if interrupt event is related to PS_INT. Write bit 0 to clear. 0 : No PS_INT event 1 : PS_INT event
5	FLG_ALS_INT	Indicate if interrupt event is related to ALS_INT. Write bit 0 to clear. 0 : No ALS_INT event 1 : ALS_INT event
6	FLG_PS_DR	Indicate PS data conversion complete. Automatically cleared after DATA_PS[15:0] is read. 0: PS data is not ready 1: PS data is ready
7	FLG_ALS_DR	Indicate ALS data conversion complete. Automatically cleared after DATA_ALS[15:0] is read. 0: ALS data is not ready 1: ALS data is ready

### DATA1 PS Register (0x11)

Bit	7	6	5	4	3	2	1	0
ITEM	DATA_PS[15:8]							
Access	RO							
Default	8'b00000000							

### DATA2 PS Register (0x12)

Bit	7	6	5	4	3	2	1	0
ITEM	DATA_PS[7:0]							
Access	RO							
Default	8'b00000000							

The STK3232 has two 8-bit read-only registers to hold the data from ADC of PS. The most significant bit (MSB) is accessed at register 0x11, and the least significant bit (LSB) is accessed at register 0x12. The registers are updated for every PS integration time (conversion cycle).

### DATA1 ALS Register (0x13)

Bit	7	6	5	4	3	2	1	0
ITEM	DATA_ALS[15:8]							
Access	RO							
Default	8'b00000000							

### DATA2 ALS Register (0x14)

Bit	7	6	5	4	3	2	1	0
ITEM	DATA_ALS[7:0]							
Access	RO							
Default	8'b00000000							

### DATA1 C Register (0x1B)

Bit	7	6	5	4	3	2	1	0
ITEM	DATA_C[15:8]							
Access	RO							
Default	8'b00000000							

### DATA2 C Register (0x1C)

Bit	7	6	5	4	3	2	1	0
ITEM	DATA_C[7:0]							
Access	RO							
Default	8'b00000000							

The STK3232 has two 8-bit read-only registers to hold each data from ADC of ALS/C. The registers are updated for every ALS/C integration time (conversion cycle).

### DATA1 PS OFFSET Register (0x1D)

Bit	7	6	5	4	3	2	1	0
ITEM	DATA_PS_OFFSET[15:8]							
Access	RW							
Default	8'b00000000							

### DATA2 PS OFFSET Register (0x1E)

Bit	7	6	5	4	3	2	1	0
ITEM	DATA_PS_OFFSET[7:0]							
Access	RW							
Default	8'b00000000							

### DATA CTIR1 Register (0x20)

Bit	7	6	5	4	3	2	1	0
ITEM	DATA_CTIR1[7:0]							
Access	RW							
Default	8'b00000000							



### DATA CTIR2 Register (0x21)

Bit	7	6	5	4	3	2	1	0
ITEM	DATA_CTIR2[7:0]							
Access	RW							
Default	8'b00000000							

### DATA CTIR3 Register (0x22)

Bit	7	6	5	4	3	2	1	0
ITEM	DATA_CTIR3[7:0]							
Access	RW							
Default	8'b00000000							

### DATA CTIR4 Register (0x23)

Bit	7	6	5	4	3	2	1	0
ITEM	DATA_CTIR4[7:0]							
Access	RW							
Default	8'b00000000							

### Product ID (0x3E)

Read Only; PDT\_ID = Product ID to indicate the product information.

### Reserved (0x3F)

Read Only; RSRVD = Reserved for engineering mode.

### ALSCTRL2 Register (0x4E)

Bit	7	6	5	4	3	2	1	0
ITEM	GAIN_C[1:0]							
Access	R/W							
Default	2'b00							

Bit	ITEM	Description								
5:4	GAIN_C[1:0]	Clear channel gain setting. GAIN_C[1:0] is used to control of the Clear channel signal gain. The ALS are controlled by GAIN_ALS[1:0].								
		<table border="1"> <tbody> <tr> <td>2'b00</td> <td>x 1 times</td> </tr> <tr> <td>2'b01</td> <td>x 4 times</td> </tr> <tr> <td>2'b10</td> <td>x 16 times</td> </tr> <tr> <td>2'b11</td> <td>x 64 times</td> </tr> </tbody> </table>	2'b00	x 1 times	2'b01	x 4 times	2'b10	x 16 times	2'b11	x 64 times
2'b00	x 1 times									
2'b01	x 4 times									
2'b10	x 16 times									
2'b11	x 64 times									

### INTELLI\_WAIT\_PS Register (0x4F)

Bit	7	6	5	4	3	2	1	0
ITEM	INTELLI_WAIT_PS[6:0]							
Access	R/W							
Default	7'b0000000							

Bit	ITEM	Description
6:0	INTELLI_WAIT_PS[6:0]	PS wait state period for intelligent persistence. wait period = (INTELLI_WAIT_PS[6:0] + 1) * 390us

### Soft reset (0x80)

Write any data to this register will reset the chip.

### INTCTRL2 Register (0xA5)

Bit	7	6	5	4	3	2	1	0
ITEM							EN_ALS_DR_INT	EN_PS_DR_INT
Access							R/W	R/W
Default							0	0

Bit	ITEM	Description
0	EN_PS_DR_INT	Enable the PS Data Ready interrupt. 0 : Disable 1 : Enable
1	EN_ALS_DR_INT	Enable the ALS Data Ready interrupt. 0 : Disable 1 : Enable

## 8. ALS RESPONSE CHARTS

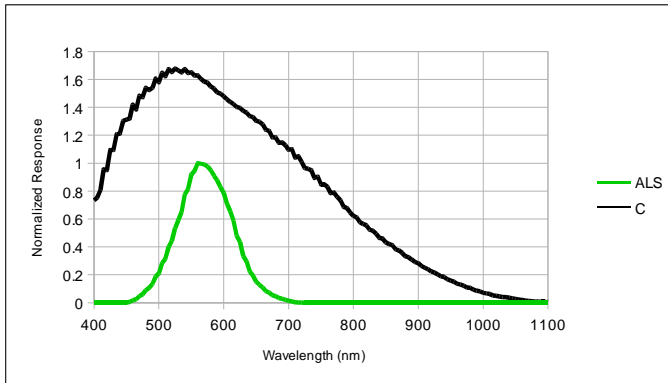

ALS Spectrum

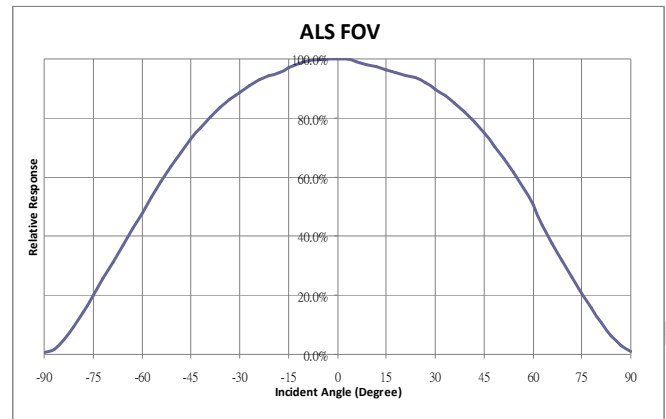

ALS FOV

**9. PROXIMITY CHARACTERISTIC**

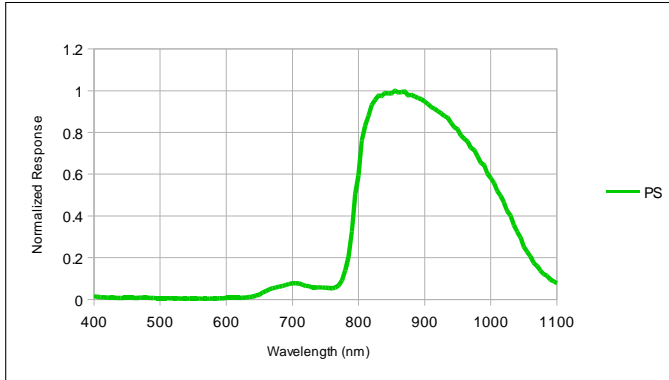

PS Spectrum

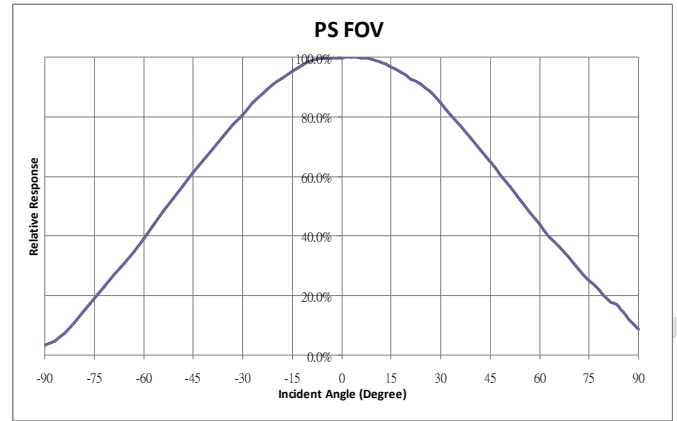

PS FOV

Confidential

## 10. APPLICATION NOTE

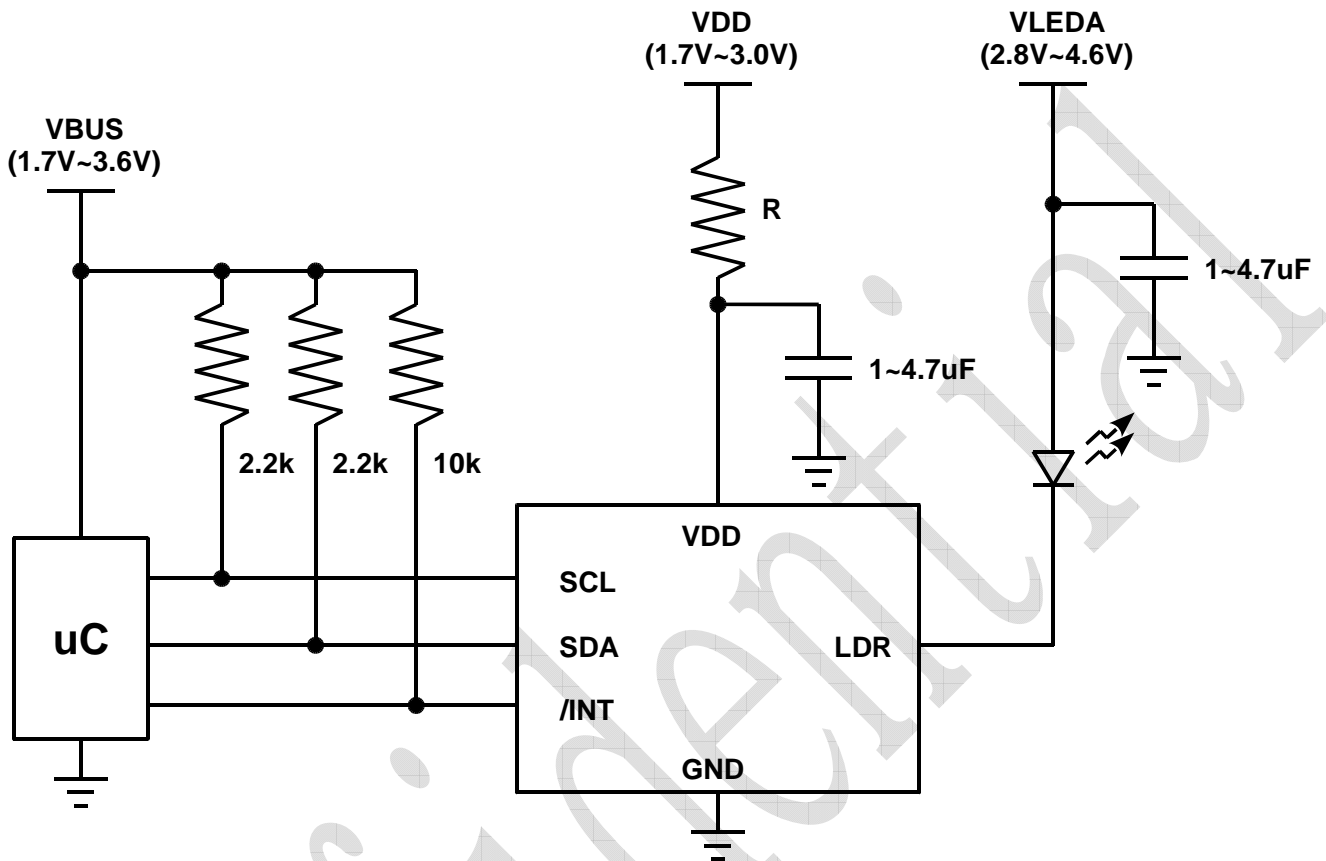

STK3232 Typical Application Circuit with Independent VDD and VLED Supply Voltage

### 10.1 Power Noise Consideration

It is suggested that IC power and  $V_{LED}$  comes from individual source to get the best performance of STK3232 and an R/C low pass filter is also suggested to be added in the  $V_{DD}$  path of STK3232 to reduce the switching noise from whole system. The recommended R value is 22 Ohm.

## 11. PACKAGE OUTLINE

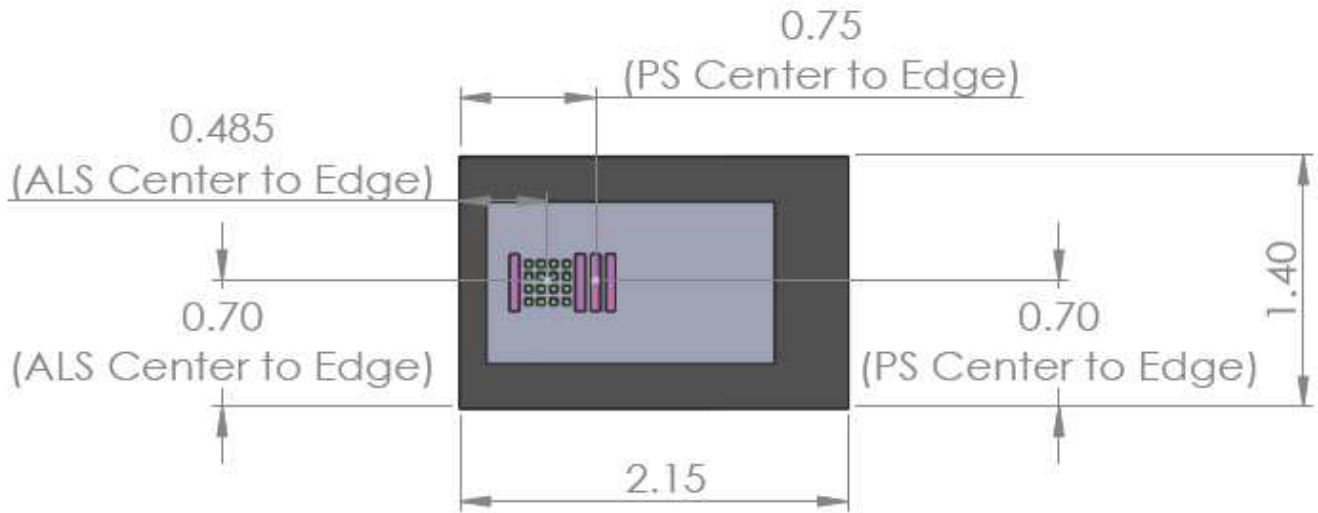
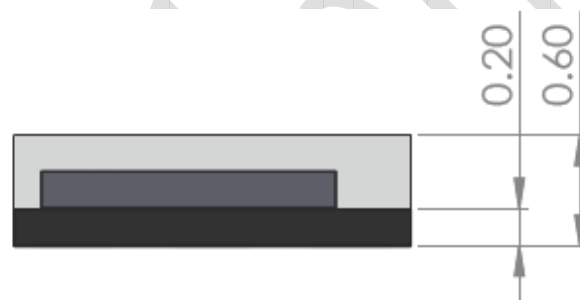
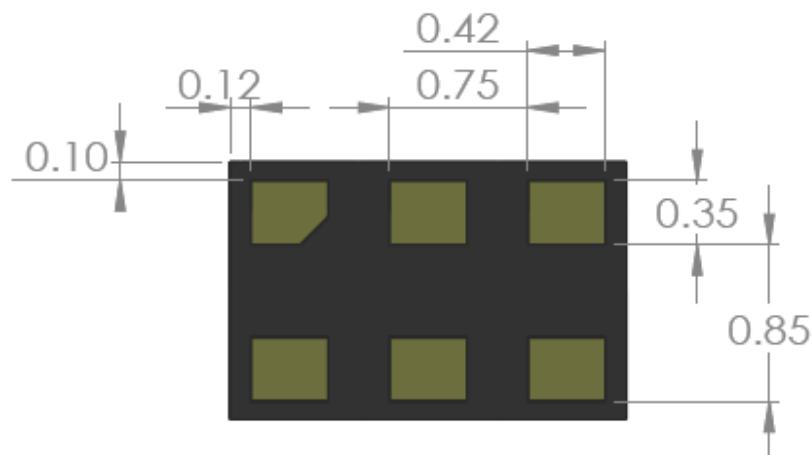
**Top View**

**Side View**

**Bottom View**

### PCB Pad Layout and Solder Mask Define Recommendation

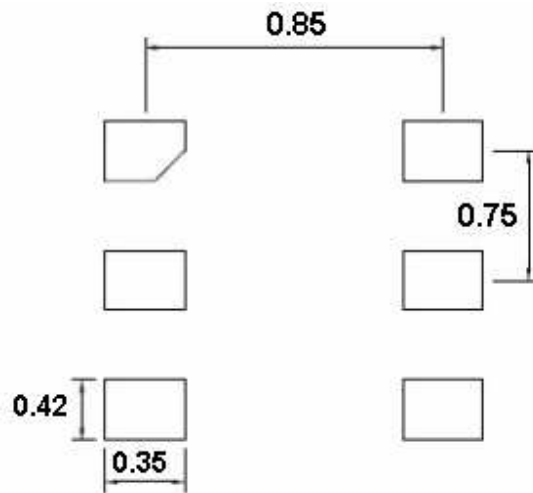
Suggested PCB pad layout guidelines for the Dual Flat No-Lead surface mount package are shown below.

PCB Pad Layout



Solder Mask Define

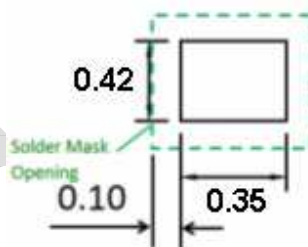

Notes: all linear dimensions are in mm.

## 12. SOLDERING INFORMATION

### 12.1 Soldering Condition

0. Pb-free solder temperature profile

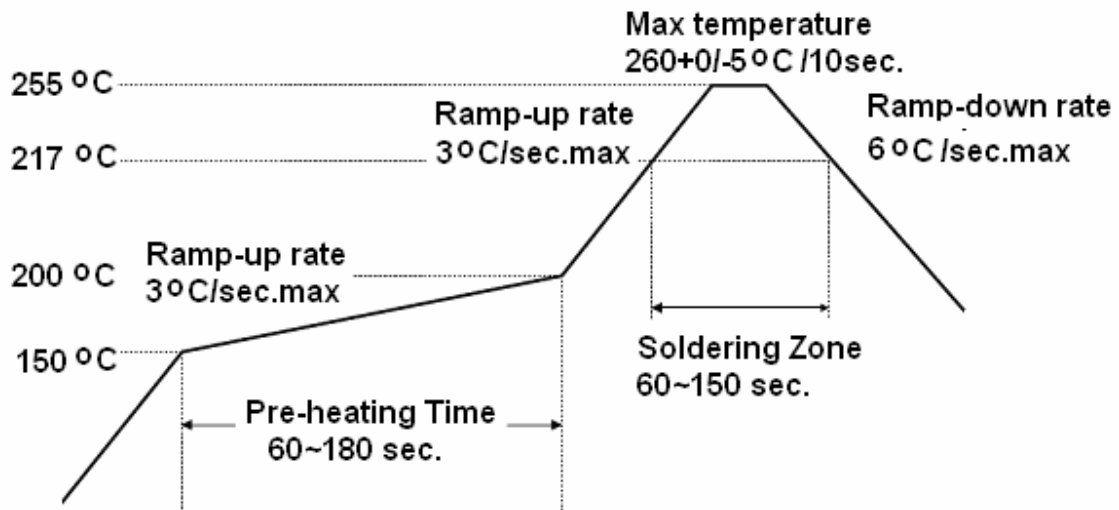

2. Reflow soldering should not be done more than three times.
3. When soldering, do not put stress on the ICs during heating.
4. After soldering, do not warp the circuit board.

### 12.2 Soldering Iron

Each terminal is to go to the tip of soldering iron temperature less than 350°C for 3 seconds within once in less than the soldering iron capacity 25W. Leave two seconds and more intervals, and do soldering of each terminal. Be careful because the damage of the product is often started at the time of the hand solder.

### 12.3 Repairing

Repair should not be done after the ICs have been soldered. When repairing is unavoidable, a double-head soldering iron should be used (as below figure). It should be confirmed beforehand whether the characteristics of the ICs will or will not be damaged by repairing.



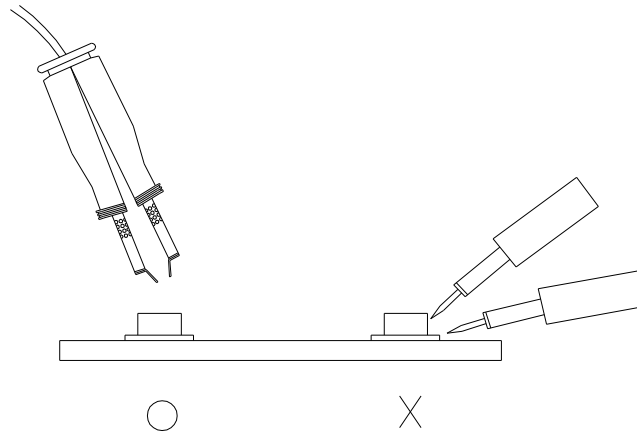

## 13. STORAGE INFORMATION

### 13.1 Storage Condition

1. Devices are packed in moisture barrier bags (MBB) to prevent the products from moisture absorption during transportation and storage. Each bag contains a desiccant.
2. The delivery product should be stored with the conditions shown below:

Storage Temperature	10 to 30°C
Relatively Humidity	below 60%RH

### 13.2 Treatment After Unsealed

1. Floor life (time between soldering and removing from MBB) must not exceed the time shown below:

Floor Life	168 Hours
Storage Temperature	10 to 30°C
Relatively Humidity	below 60%RH

2. When the floor life limits have been exceeded or the devices are not stored in dry conditions, they must be re-baked before reflow to prevent damage to the devices. The recommended conditions are shown below

Temperature	60°C
Re-Baking Time	12 Hours

## 14. TAPE AND REEL DIMENSION

TBD

Notes: all linear dimensions are in mm.

Confidential

## Revision History

Date	Version	Modified Items
2018/2/27	0.9.0	Initial release.

### Important Notice

This document contains information that is proprietary to Sensortek Technology Corp. ("sensortek"), and is subject to change without notice. Any part of this document may not be used, reproduced, duplicated or disclosed in any form or any means without the prior written permission of sensortek.

Sensortek does not warrant or represent that any license, either express or implied, is granted under any sensortek's patent right, copyright, mask work right, or other intellectual property right relating to any combination, machine, or process in which sensortek's products or services are used. In addition, Sensortek does not assume any liability for the occurrence of infringing on any patent or other intellectual property rights of a third party.

Sensortek reserves the right to make corrections, modifications, enhancements, improvements, and other changes to its products and services at any time and to discontinue any product or service without notice. Customers should obtain the latest relevant information before placing orders and should verify that such information is current and complete.

单击下面可查看定价，库存，交付和生命周期等信息

[>>Sensortek \(升佳电子\)](#)