

Applicable for automotive exterior light

WICOP-B 1x1 Amber

SWA0Y1XA

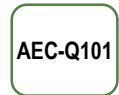
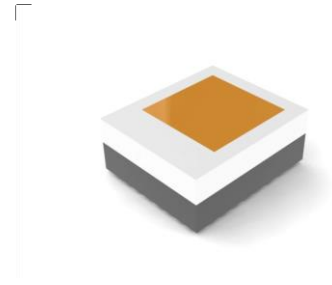

Product Brief

Description

- The Compact LED series is designed for high current operation and high flux output applications.
- It incorporates state of the art SMD design and low thermal resistant material.
- The Compact LED is ideal light sources for automotive applications and mobile flash, general lighting.

Features and Benefits

- Super high Flux output and high Luminance
- Designed for high current operation
- SMT solderable
- Lead Free product
- Compact module design available.

Key Applications

- Automotive Lighting

Table of Contents

Index	
• Product Brief	1
• Table of Contents	2
• Performance Characteristics	3
• Characteristics Graph	5
• Color Bin Structure	11
• Mechanical Dimensions	13
• Recommended Solder Pad	14
• Reflow Soldering Characteristics	15
• Emitter Tape & Reel Packaging	16
• Product Nomenclature	18
• Handling of Silicone Resin for LEDs	19
• Precaution For Use	20
• Company Information	23

Performance Characteristics

Table 1. Characteristics, IF = 350mA, Tj = 25°C

Parameter	Symbol	Min	Typ	Max	Unit
Forward Voltage ^{[1],[2],[4]}	V_F	2.75	3.13	3.5	V
Luminous Flux ^{[1],[3],[4]}	Φ_V		75		lm
Luminous Flux ^{[1],[3],[4]} @1A (Reference only)	Φ_V		165		lm
Chromaticity Coordinates ^{[1],[4],[5]}	CIE_x		0.57		
	CIE_y		0.42		
Viewing Angle	$2\theta_{1/2}$		120		deg.
Real Thermal resistance	$R_{th JS}$		5.0	7.0	K / W
Electrical Thermal resistance	$R_{th JS}$		4.0	6.0	K / W
Temperature coefficient of V_F -40°C ≤ T ≤ 135 °C	TC_{V_F}		-2.5		mV/K
Temperature coefficient of color coordinates -40°C ≤ T ≤ 135 °C	TC_x		-0.05		10 ⁻³ /K
	TC_y		-0.05		10 ⁻³ /K

Notes :

[1] Tolerance : V_F : ±0.05V, Φ_V : ±8%, CIE_x , CIE_y : ±0.005

[2] LEDs are to be classified in forward voltage groups if requested by Customer. Minimum and maximum values include all tolerances.

[3] LEDs are to be classified in luminous flux groups. The ratio of the group limits ($\Phi_{V,max}/\Phi_{V,min}$) must not

[4] Parameter has to be checked by 100% in the production process.

[5] LEDs are to be classified in colour bins if requested by Customer.

Colour bins and tolerances are program specific and will be agreed by sample evaluation between SSC and the customer. The colour coordinates of the application have to fulfil ECE /SAE legislation, whereby the binning range must not exceed 0.02 typically. Minimum and maximum values include all tolerances.

Performance Characteristics

Table 2. Absolute Maximum Ratings

Parameter	Symbol	Value	Unit
Forward Current ($T_a=25^{\circ}\text{C}$)	I_F	50 ~ 1000	mA
Operating Temperature	T_{opr}	-40 ~ +125	$^{\circ}\text{C}$
Storage Temperature	T_{stg}	-40 ~ +125	$^{\circ}\text{C}$
Junction Temperature	T_j	135	$^{\circ}\text{C}$
Soldering Temperature	T_{sld}	Reflow Soldering : 260 $^{\circ}\text{C}$ for 10sec. Hand Soldering : 315 $^{\circ}\text{C}$ for 4sec.	
ESD (HBM) (R=1.5k Ω , C= 100pF)		Class 3B (JESD22-A114-E)	-

Notes :

- [1] LEDs are to be classified in forward voltage groups if requested by Customer. Minimum and maximum values include all tolerances.
- [2] LEDs are to be classified in luminous flux groups. The ratio of the group limits ($\Phi_{V,max}/\Phi_{V,min}$) must not exceed 1,6 including measurement tolerances. Minimum and maximum values include all tolerances.
- [3] LEDs are to be classified in color bins if requested by Customer.
Color bins and tolerances are program specific and will be agreed by sample evaluation between SSC and the customer. The color coordinates of the application have to fulfill ECE /SAE legislation, whereby the binning range must not exceed 0.02 typically. Minimum and maximum values include all tolerances.
- [4] Subject to Human Body Model / JESD22-A114.
- [5] Parameter has to be checked by 100% in the production process.

Characteristics Graph

Fig 1. Relative Intensity vs. Wavelength , $I_F = 350\text{mA}$, $T_j = 25^\circ\text{C}$

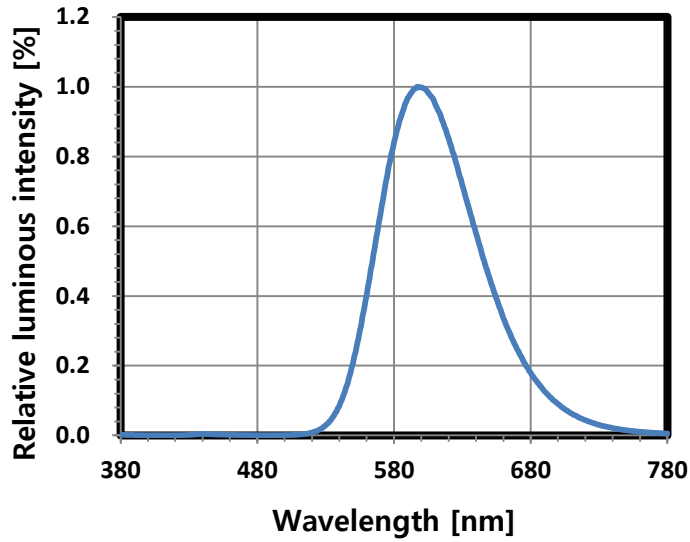

Characteristics Graph

Fig 2. Relative Intensity vs. Angle, $T_j = 25^\circ\text{C}$

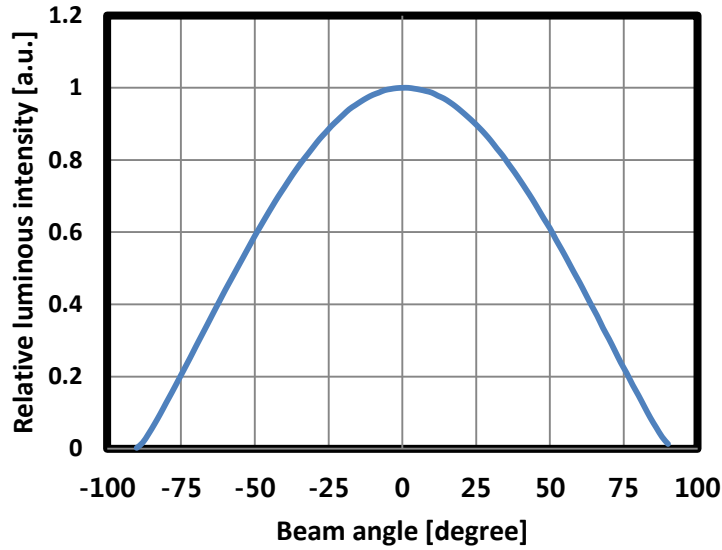
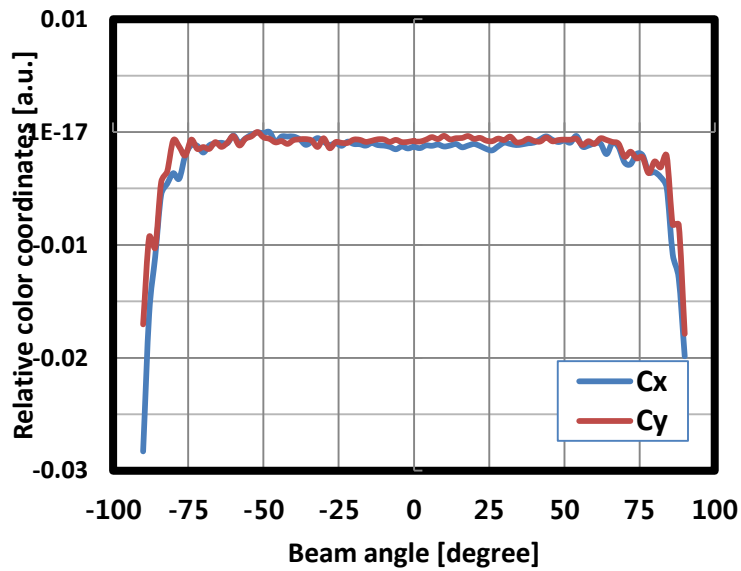

Fig 3. Distribution of color coordinates vs. Radiation Angle , $T_j = 25^\circ\text{C}$



Characteristics Graph

Fig 4. Forward Current vs. Forward Voltage, $T_j=25^\circ\text{C}$

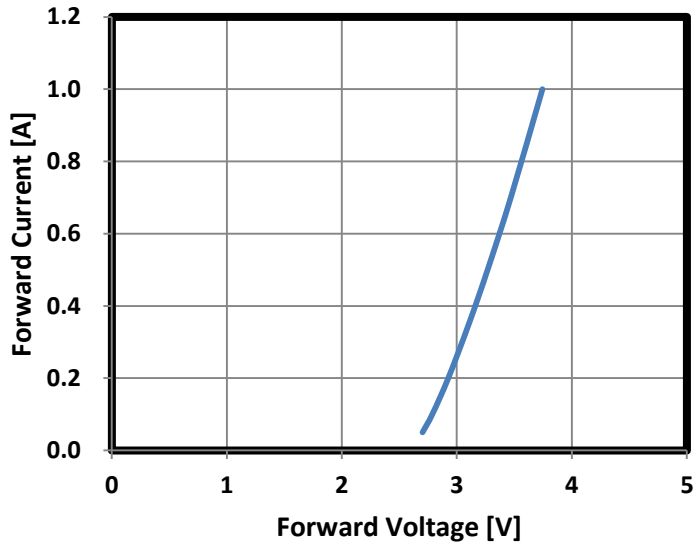
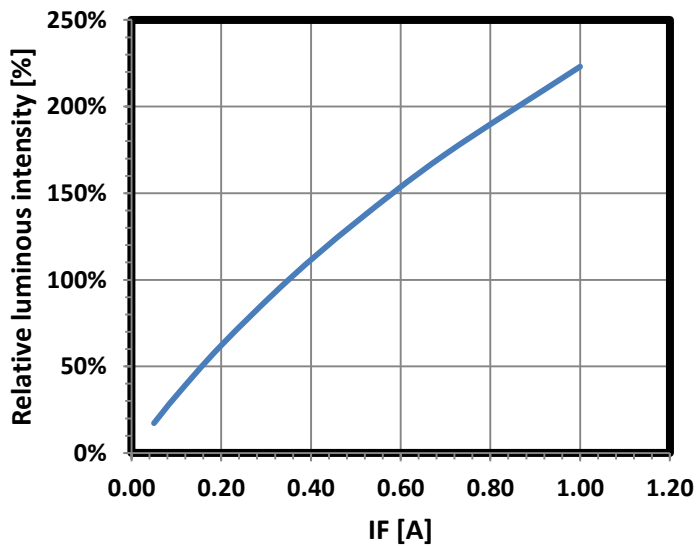
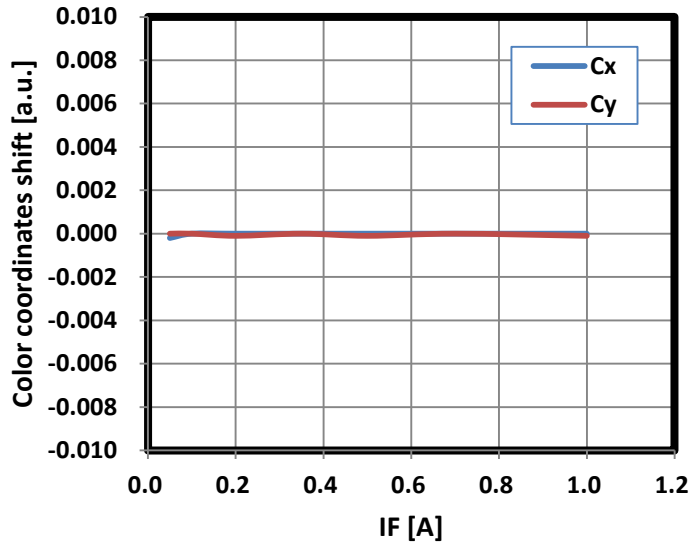

Fig 5. Forward Current vs. Relative Luminous Flux, $T_j=25^\circ\text{C}$



Characteristics Graph

Fig 6. Forward Current vs. CIE X, Y Shift , Tj=25°C



Characteristics Graph

Fig 7. Junction Temperature vs. Relative Light Output, $I_F=350\text{mA}$

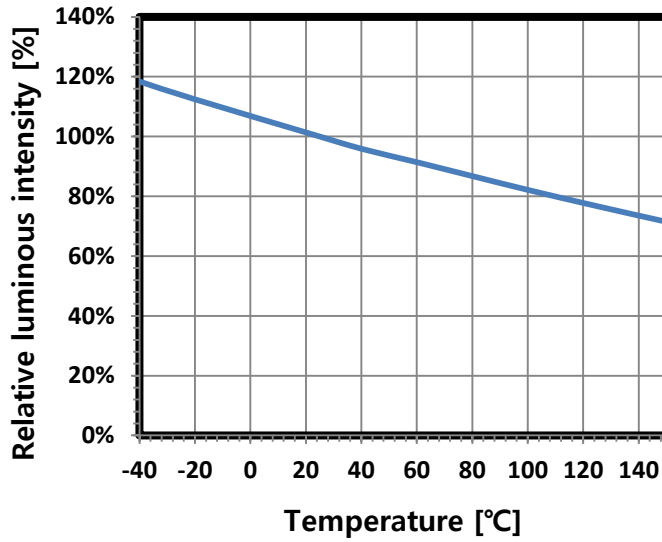
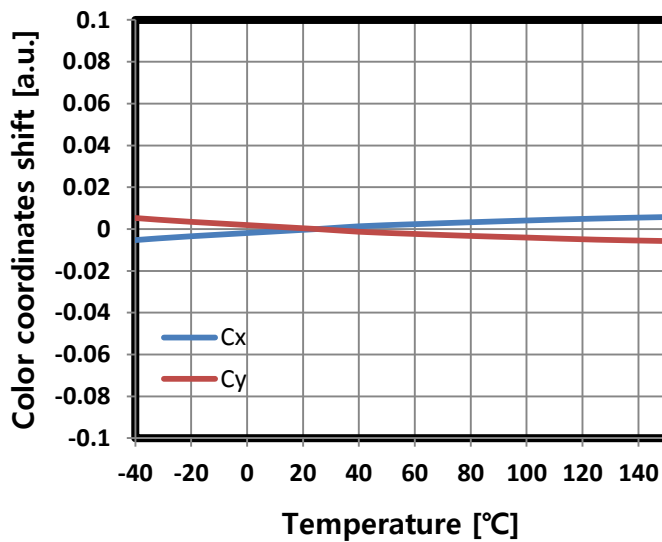

Fig 8. Junction Temperature vs. CIE X, Y Shift , $T_j=25^\circ\text{C}$



Characteristics Graph

Fig 9. Ambient temperature vs. Forward Voltage, $I_F=350\text{mA}$

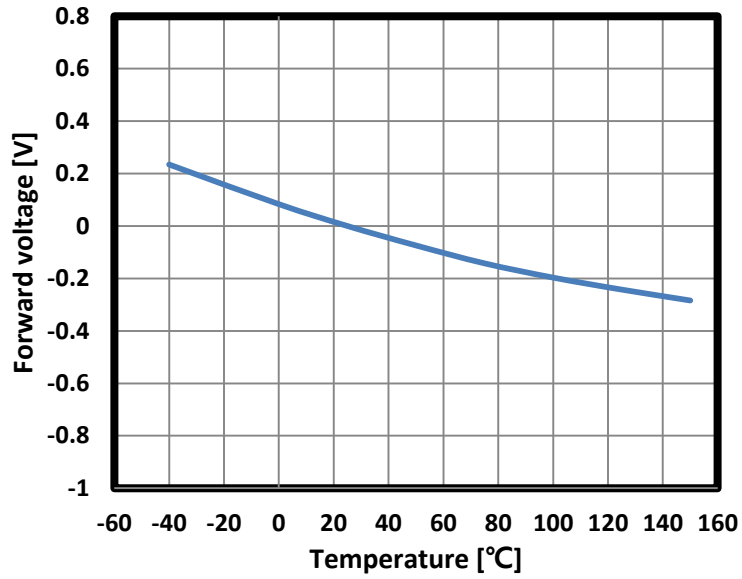
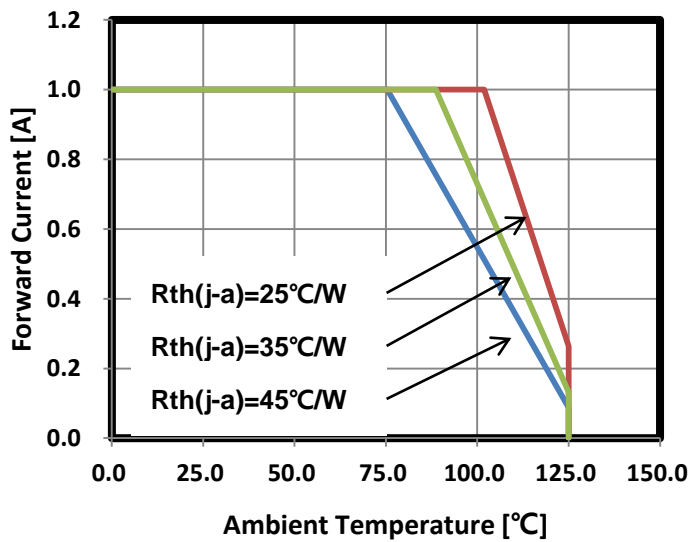

Fig 10. Maximum Forward Current vs. Ambient Temperature, $T_j(\text{max.}) = 135^\circ\text{C}$



Color Bin Structure

Table 3. Bin Code description

Part Number	Luminous Flux (lm) @ $I_F = 0.35A$			Color Chromaticity Coordinate @ $I_F = 0.35A$	Forward Voltage (V_F) @ $I_F = 0.35A$		
	Bin Code	Min.	Max.		Bin Code	Min.	Max.
SWA0Y1XA	S2	60	70	Refer to page.12	G	2.75	3.00
	T1	70	80		H	3.00	3.25
	T2	80	90				
	U1	90	100		I	3.25	3.50

Color Bin Structure

CIE Chromaticity Diagram, $T_j=25^\circ\text{C}$, $I_f=350\text{mA}$

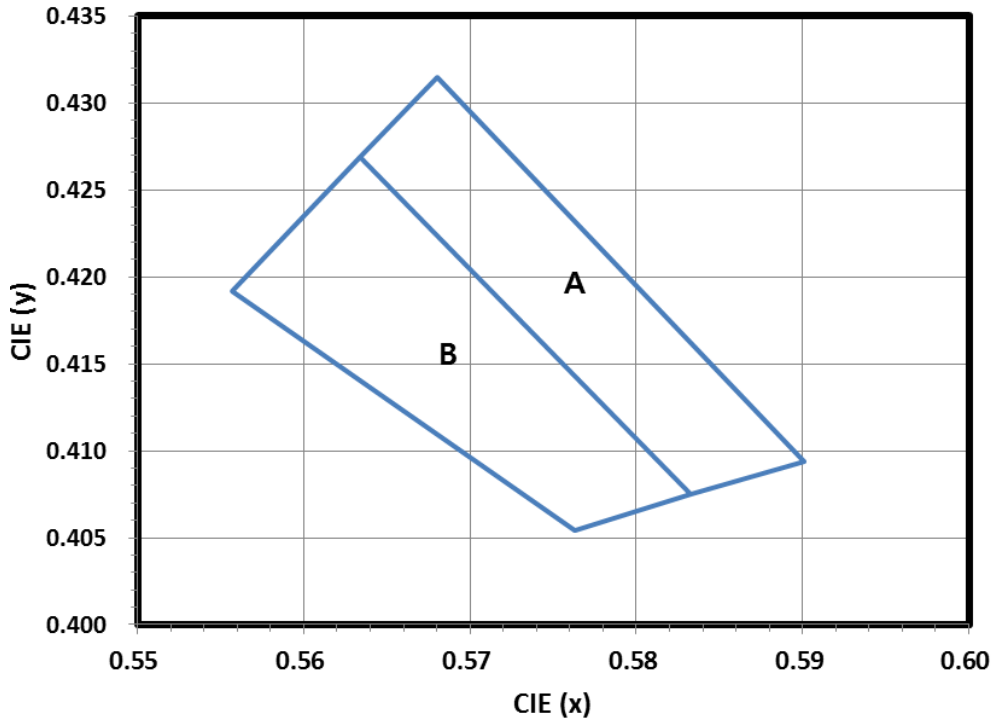

A		B	
CIE x	CIE y	CIE x	CIE y
0.5680	0.4315	0.5763	0.4054
0.5634	0.4269	0.5833	0.4075
0.5833	0.4075	0.5634	0.4269
0.5901	0.4094	0.5557	0.4192

Mechanical Dimensions

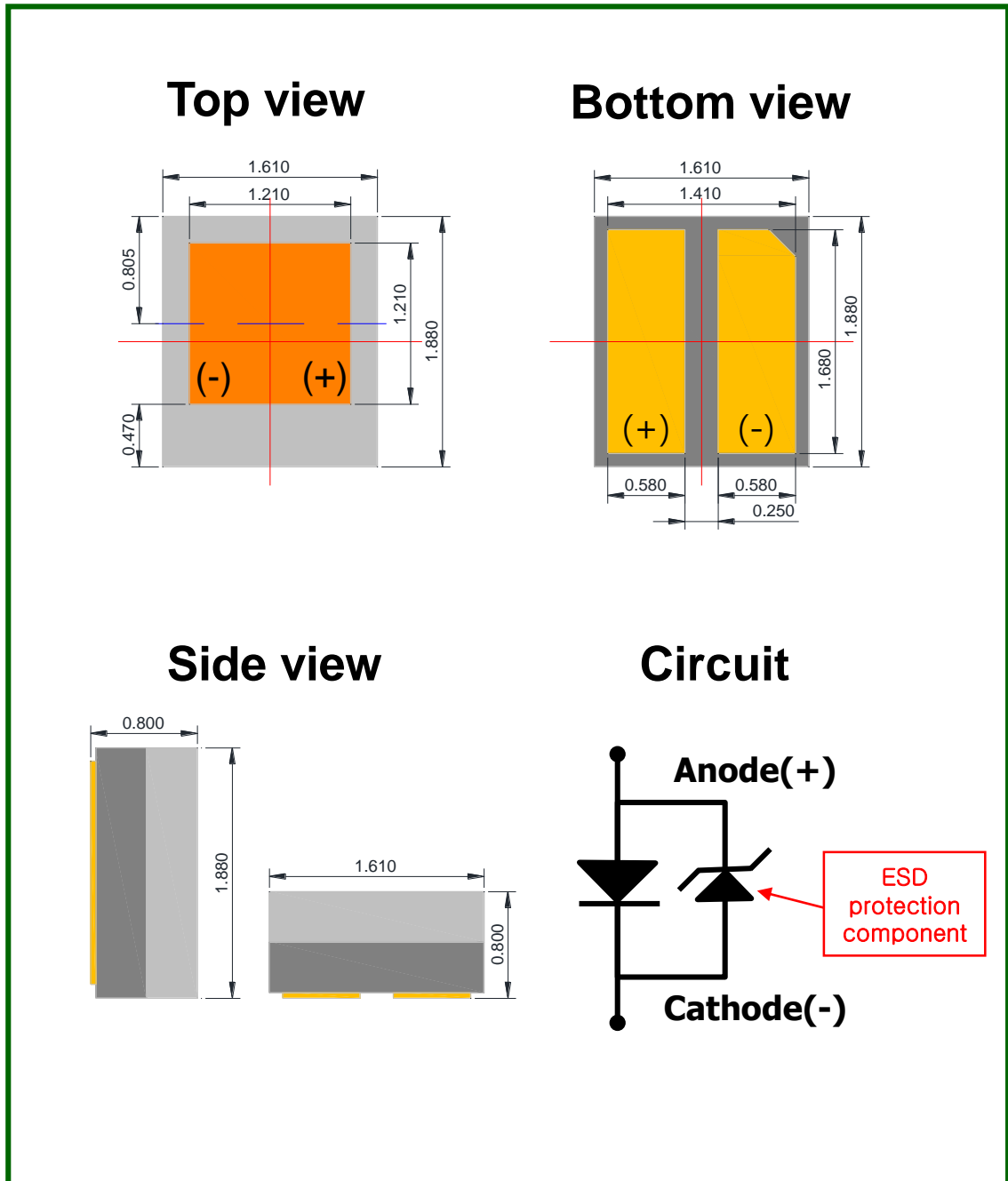

Notes :

1. All dimensions are in millimeters.
2. Scale : none
3. Undefined tolerance is ± 0.1 mm

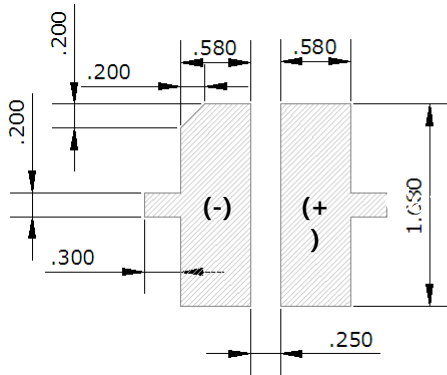
Recommended Solder Pad

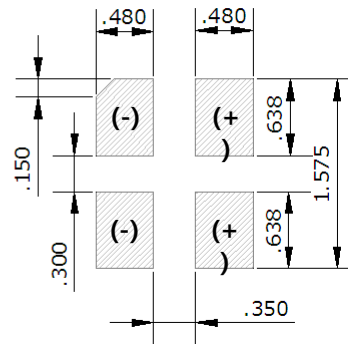

<Recommended solder pad>



<Recommended stencil pattern>

Notes :

1. All dimensions are in millimeters.
2. Scale : none
3. This drawing without tolerances are for reference only
4. Undefined tolerance is ± 0.1 mm

Reflow Soldering Characteristics

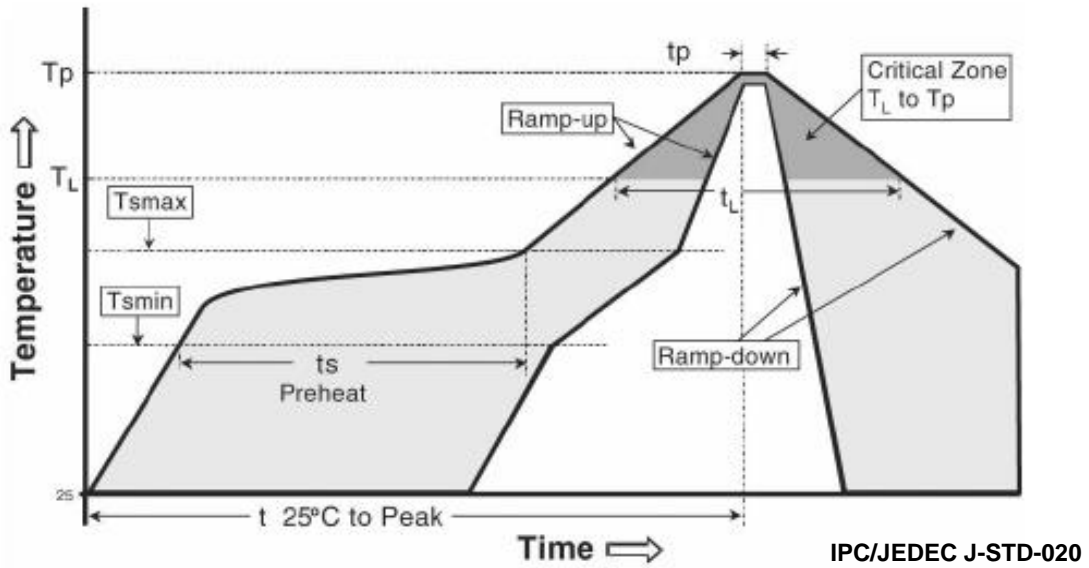

Profile Feature	Sn-Pb Eutectic Assembly	Pb-Free Assembly
Average ramp-up rate (T _{smax} to T _p)	3° C/second max.	3° C/second max.
Preheat - Temperature Min (T _{smin}) - Temperature Max (T _{smax}) - Time (T _{smin} to T _{smax}) (t _s)	100 °C 150 °C 60-120 seconds	150 °C 200 °C 60-180 seconds
Time maintained above: - Temperature (T _L) - Time (t _L)	183 °C 60-150 seconds	217 °C 60-150 seconds
Peak Temperature (T _p)	215°C	260°C
Time within 5°C of actual Peak Temperature (t _p) ²	10-30 seconds	20-40 seconds
Ramp-down Rate	6 °C/second max.	6 °C/second max.
Time 25°C to Peak Temperature	6 minutes max.	8 minutes max.

Caution

1. Reflow soldering is recommended not to be done more than two times. In the case of more than 24 hours passed soldering after first, LEDs will be damaged.
2. Repairs should not be done after the LEDs have been soldered. When repair is unavoidable, suitable tools must be used.
3. Die slug is to be soldered.
4. When soldering, do not put stress on the LEDs during heating.
5. After soldering, do not warp the circuit board.

Emitter Tape & Reel Packaging

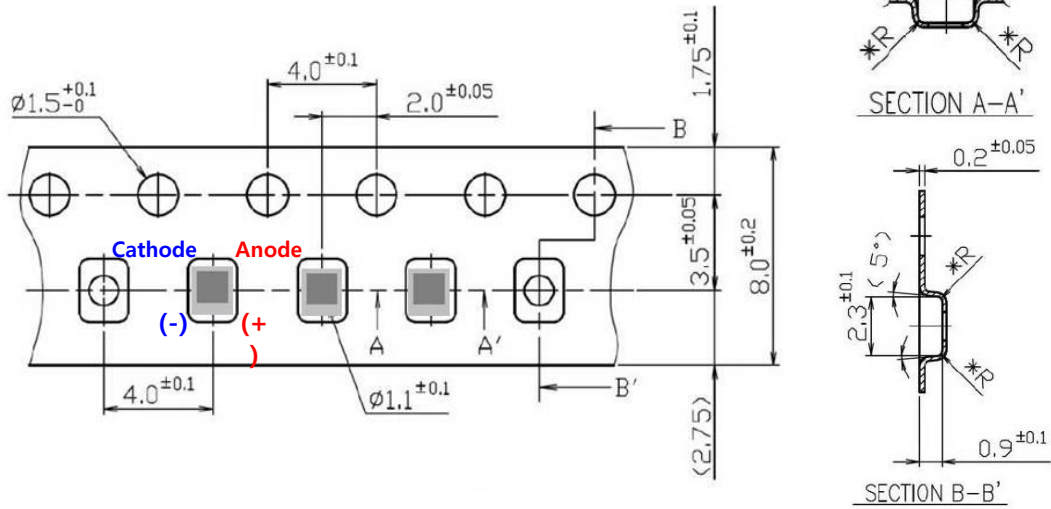

(Tolerance: ± 0.2 , Unit: mm)

- (1) Quantity : 1000pcs/Reel (Can be blank , less than 20)
- (2) Cumulative Tolerance : Cumulative Tolerance/10 pitches to be ± 0.2 mm
- (3) Adhesion Strength of Cover Tape : Adhesion strength to be 0.1-0.7N when the cover tape is turned off from the carrier tape at the angle of 10° to the carrier tape
- (4) Package : P/N, Manufacturing data Code No. and quantity to be indicated on a damp proof Package

Emitter Tape & Reel Packaging

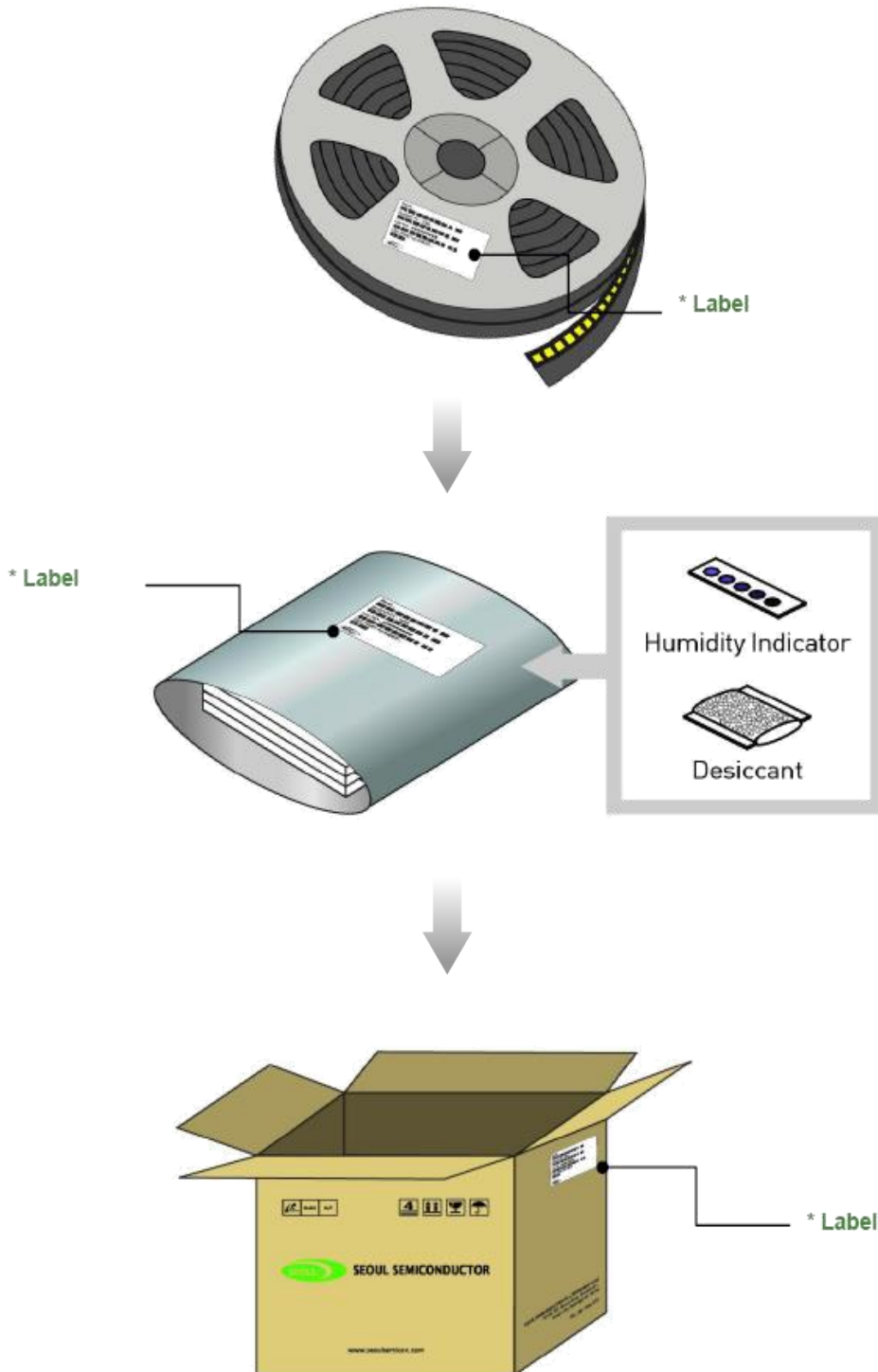

* Please refer to the next page for the 'Labeling Information' and 'Product Nomenclature'.

Product Nomenclature

Table 4. Part Numbering System : X₁X₂X₃X₄X₅X₆X₇X₈

Part Number Code	Description	Part Number	Value
X ₁	Company	S	SSC
X ₂	Package Type	W	WICOP
X ₃ X ₄	Color	A0	AMBER
X ₅	Chip Type	Y	-
X ₆ X ₇	Chip Number	1X	1CHIP
X ₈	Product Revision	A	-

Table 5. Lot Numbering System : Y₁Y₂Y₃Y₄Y₅Y₆Y₇Y₈Y₉Y₁₀-Y₁₁Y₁₂Y₁₃Y₁₄Y₁₅Y₁₆Y₁₇

Lot Number Code	Description	Lot Number	Value
Y ₁ Y ₂	Year		
Y ₃	Month		
Y ₄ Y ₅	Day		
Y ₆	Top View LED series		
Y ₇ Y ₈ Y ₉ Y ₁₀	Mass order		
Y ₁₁ Y ₁₂ Y ₁₃ Y ₁₄ Y ₁₅ Y ₁₆ Y ₁₇	Internal Number		

Handling of Silicone Resin for LEDs

1. During processing, mechanical stress on the surface should be minimized as much as possible. Sharp objects of all types should not be used to pierce the sealing compound.



2. In general, LEDs should only be handled from the side. By the way, this also applies to LEDs without a silicone sealant, since the surface can also become scratched.
3. When populating boards in SMT production, there are basically no restrictions regarding the form of the pick and place nozzle, except that mechanical pressure on the surface of the resin must be prevented. This is assured by choosing a pick and place nozzle which is larger than the LED's reflector area.
4. Silicone differs from materials conventionally used for the manufacturing of LEDs. These conditions must be considered during the handling of such devices. Compared to standard encapsulants, silicone is generally softer, and the surface is more likely to attract dust. As mentioned previously, the increased sensitivity to dust requires special care during processing. In cases where a minimal level of dirt and dust particles cannot be guaranteed, a suitable cleaning solution must be applied to the surface after the soldering of components.
5. Seoul Semiconductor suggests using isopropyl alcohol for cleaning. In case other solvents are used, it must be assured that these solvents do not dissolve the package or resin. Ultrasonic cleaning is not recommended. Ultrasonic cleaning may cause damage to the LED.
6. Please do not mold this product into another resin (epoxy, urethane, etc) and do not handle this product with acid or sulfur material in sealed space.
7. Avoid leaving fingerprints on silicone resin parts.

Precaution for Use

(1) Storage

To avoid the moisture penetration, we recommend store in a dry box with a desiccant.
The recommended storage temperature range is 5°C to 30°C and a maximum humidity of RH50%.

(2) Use Precaution after Opening the Packaging

Use SMT techniques properly when you solder the LED as separation of the lens may affect the light output efficiency.

Pay attention to the following:

a. Recommend conditions after opening the package

- Sealing
- Temperature : 5 ~ 40°C Humidity : less than RH30%

b. If the package has been opened more than 1 year (MSL_2) or the color of the desiccant changes, components should be dried for 10-12hr at 60±5°C

(3) Do not apply mechanical force or excess vibration during the cooling process to normal temperature after soldering.

(4) Do not rapidly cool device after soldering.

(5) Components should not be mounted on warped (non coplanar) portion of PCB.

(6) Radioactive exposure is not considered for the products listed here in.

(7) Gallium arsenide is used in some of the products listed in this publication.

These products are dangerous if they are burned or shredded in the process of disposal.
It is also dangerous to drink the liquid or inhale the gas generated by such products when chemically disposed of.

(8) This device should not be used in any type of fluid such as water, oil, organic solvent and etc. When washing is required, IPA (Isopropyl Alcohol) should be used.

(9) When the LEDs are in operation the maximum current should be decided after measuring the package temperature.

(10) LEDs must be stored properly to maintain the device. If the LEDs are stored for 3 months or more after being shipped from SSC, a sealed container with a nitrogen atmosphere should be used for storage.

Precaution for Use

- (11) The appearance and specifications of the product may be modified for improvement without notice.
- (12) Long time exposure of sunlight or occasional UV exposure will cause lens discoloration.
- (13) VOCs (Volatile organic compounds) emitted from materials used in the construction of fixtures can penetrate silicone encapsulants of LEDs and discolor when exposed to heat and photonic energy. The result can be a significant loss of light output from the fixture. Knowledge of the properties of the materials selected to be used in the construction of fixtures can help prevent these issues.
- (14) The slug is electrically isolated.
- (15) Attaching LEDs, do not use adhesives that outgas organic vapor.
- (16) The driving circuit must be designed to allow forward voltage only when it is ON or OFF.
If the reverse voltage is applied to LED, migration can be generated resulting in LED damage.
- (17) Similar to most Solid state devices;
LEDs are sensitive to Electro-Static Discharge (ESD) and Electrical Over Stress (EOS).
Below is a list of suggestions that Seoul Semiconductor purposes to minimize these effects.

a. ESD (Electro Static Discharge)

Electrostatic discharge (ESD) is defined as the release of static electricity when two objects come into contact. While most ESD events are considered harmless, it can be an expensive problem in many industrial environments during production and storage. The damage from ESD to an LEDs may cause the product to demonstrate unusual characteristics such as:

- Increase in reverse leakage current lowered turn-on voltage
- Abnormal emissions from the LED at low current

The following recommendations are suggested to help minimize the potential for an ESD event. One or more recommended work area suggestions:

- Ionizing fan setup
- ESD table/shelf mat made of conductive materials
- ESD safe storage containers

One or more personnel suggestion options:

- Antistatic wrist-strap
- Antistatic material shoes
- Antistatic clothes

Precaution for Use

Environmental controls:

- Humidity control (ESD gets worse in a dry environment)

b. EOS (Electrical Over Stress)

Electrical Over-Stress (EOS) is defined as damage that may occur when an electronic device is subjected to a current or voltage that is beyond the maximum specification limits of the device.

The effects from an EOS event can be noticed through product performance like:

- Changes to the performance of the LED package
(If the damage is around the bond pad area and since the package is completely encapsulated the package may turn on but flicker show severe performance degradation.)
- Changes to the light output of the luminaire from component failure
- Components on the board not operating at determined drive power

Failure of performance from entire fixture due to changes in circuit voltage and current across total circuit causing trickle down failures. It is impossible to predict the failure mode of every LED exposed to electrical overstress as the failure modes have been investigated to vary, but there are some common signs that will indicate an EOS event has occurred:

- Damaged may be noticed to the bond wires (appearing similar to a blown fuse)
- Damage to the bond pads located on the emission surface of the LED package
(shadowing can be noticed around the bond pads while viewing through a microscope)
- Anomalies noticed in the encapsulation and phosphor around the bond wires
- This damage usually appears due to the thermal stress produced during the EOS event

c. To help minimize the damage from an EOS event Seoul Semiconductor recommends utilizing:

- A surge protection circuit
- An appropriately rated over voltage protection device
- A current limiting device



Company Information

Published by

Seoul Semiconductor © 2013 All Rights Reserved.

Company Information

Seoul Semiconductor (SeoulSemicon.com) manufactures and packages a wide selection of light emitting diodes (LEDs) for the automotive, general illumination/lighting, appliance, signage and back lighting markets. The company is the world's fifth largest LED supplier, holding more than 10,000 patents globally, while offering a wide range of LED technology and production capacity in areas such as "nPola", deep UV LEDs, "Acrich", the world's first commercially produced AC LED, and "Acrich MJT - Multi-Junction Technology" a proprietary family of high-voltage LEDs. The company's broad product portfolio includes a wide array of package and device choices such as Acrich, high-brightness LEDs, mid-power LEDs, side-view LEDs, through-hole type LED lamps, custom displays, and sensors. The company is vertically integrated from epitaxial growth and chip manufacture in its fully owned subsidiary, Seoul Viosys, through packaged LEDs and LED modules in three Seoul Semiconductor manufacturing facilities. Seoul Viosys also manufactures a wide range of unique deep-UV wavelength devices.

Legal Disclaimer

Information in this document is provided in connection with Seoul Semiconductor products. With respect to any examples or hints given herein, any typical values stated herein and/or any information regarding the application of the device, Seoul Semiconductor hereby disclaims any and all warranties and liabilities of any kind, including without limitation, warranties of non-infringement of intellectual property rights of any third party. The appearance and specifications of the product can be changed to improve the quality and/or performance without notice. The values on the datasheet could change without notice.

单击下面可查看定价，库存，交付和生命周期等信息

[>>Seoul Semiconductor\(首尔半导体\)](#)