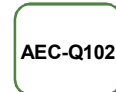
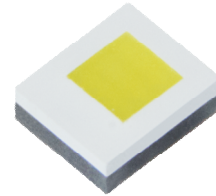


High reliability and High quality of light

High-Power LED for Automotive

SWW0CS10B



Product Brief

Description

- The WICOP LED series is designed for high current operation and high flux output applications.
- It incorporates state of the art SMD design and low thermal resistant material.
- The WICOP LED is ideal light sources for automotive applications.

Features and Benefits

- Super high Flux output and high Luminance
- Designed for high current operation
- Lead Free product
- Compact module design available
- ESD Class 3B / MSL 2 Level
- Viewing angle 120°

Key Applications

- Automotive Lighting

Table of Contents

Index	
• Product Brief	1
• Table of Contents	2
• Performance Characteristics	3
• Color Bin Structure	11
• Mechanical Dimensions	13
• Recommended Solder Pad	14
• Reflow Soldering Characteristics	15
• Emitter Tape & Reel Packaging	16
• Product Nomenclature	18
• Handling of Silicone Resin for LEDs	19
• Precaution for Use	20
• Company Information	23

Performance Characteristics

Table 1. Electro Optical Characteristics, $I_F = 1.0A$, $T_a = 25^\circ C$

Parameter	Symbol	Min	Typ	Max	Unit
Forward Voltage	V_F	-	3.20	3.50	V
Luminous Flux	Φ_V	-	350	-	lm
Color Coordinates	$CIE\ x$		0.325		
	$CIE\ y$		0.335		
Viewing Angle	2θ		120		deg. [°]
Electrical Thermal resistance	$R_{th\ JS\ el}$	-	3.0	3.8	K / W
Real Thermal resistance	$R_{th\ JS\ real}$	-	4.3	5.3	K / W

Notes :

[1] All measurements were made under the standardized environment of Seoul semiconductor.

[2] Tolerance : $V_F : \pm 0.1V$, $\Phi_V : \pm 5\%$, CIE_x , $CIE_y : \pm 0.005$

Performance Characteristics

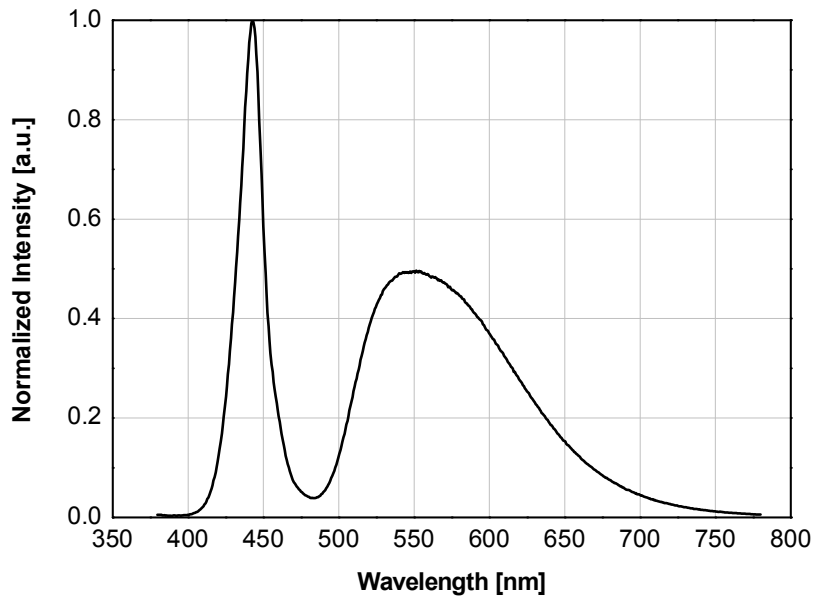
Table 2. Absolute Maximum Ratings

Parameter	Symbol	Value	Unit
Forward Current ($T_a=25^\circ\text{C}$)	I_F	0.05 ~ 1.50	A
Pulse Forward Current $t \leq 10 \mu\text{s}$, $D = 0.005$, $T_S = 25^\circ\text{C}$	I_{FP}	2.0	A
Operating Temperature	T_{opr}	-40 ~ +125	$^\circ\text{C}$
Storage Temperature	T_{stg}	-40 ~ +125	$^\circ\text{C}$
Junction Temperature	T_j	150	$^\circ\text{C}$
ESD (HBM) ($R=1.5\text{k}\Omega$, $C=100\text{pF}$)		Class 3B (JESD22-A114-E)	-

Notes :

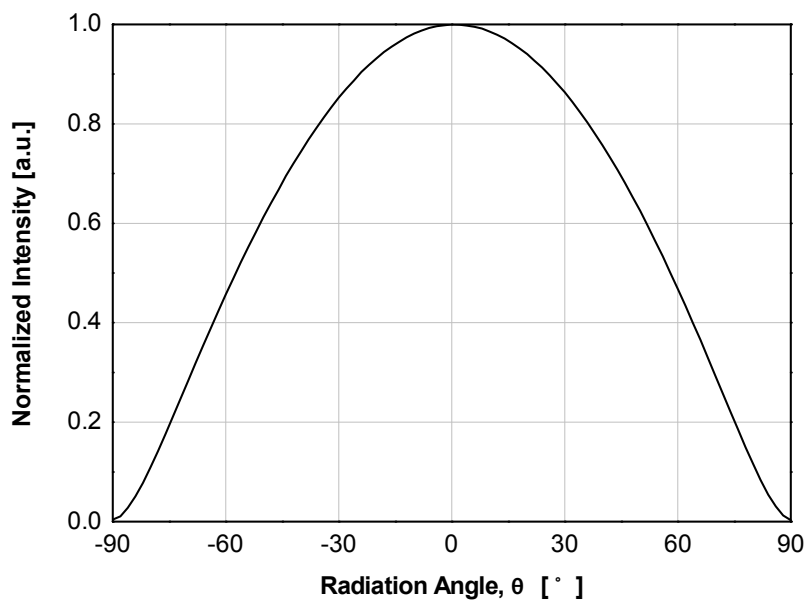
[1] All measurements were made under the standardized environment of Seoul semiconductor

Performance Characteristics

Fig 1. Color Spectrum, $I_F = 1.0A$, $T_a = 25^\circ C$


[NOTE]

- 1) Percentage of red : > 5% acc. to ECE regulation
- 2) Percentage of UV : < 10^{-5} W/lm acc. to ECE regulation

Fig 2. Radiant Pattern, $T_a = 25^\circ C$


Performance Characteristics

Fig 3. Forward Voltage vs. Forward Current, $T_a = 25^\circ\text{C}$

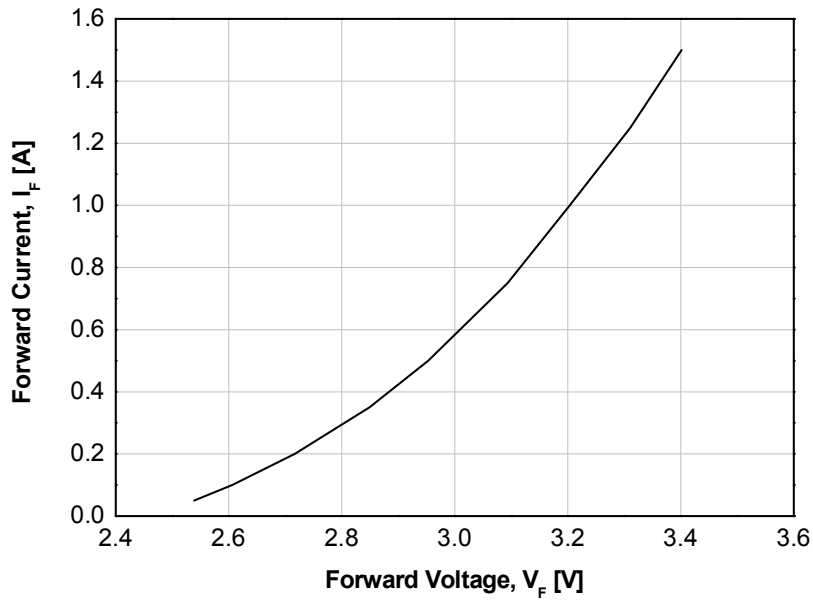
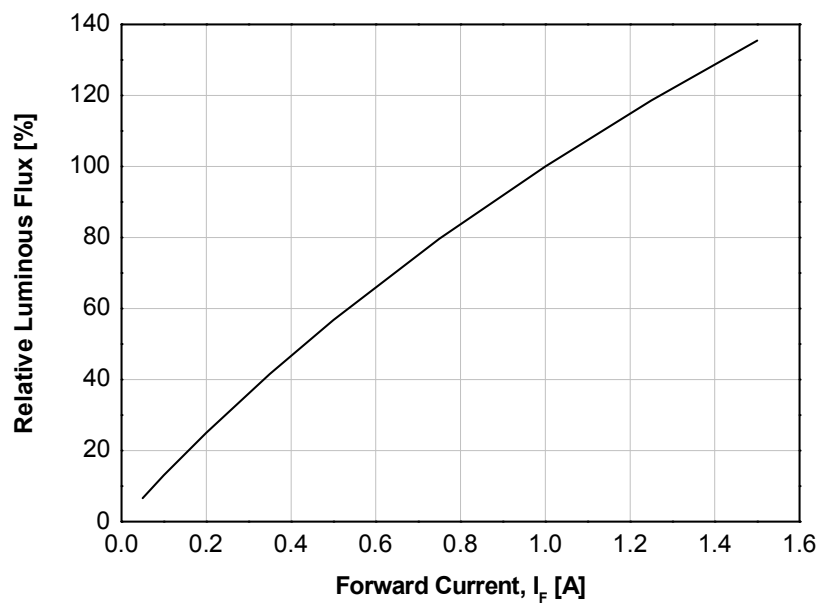
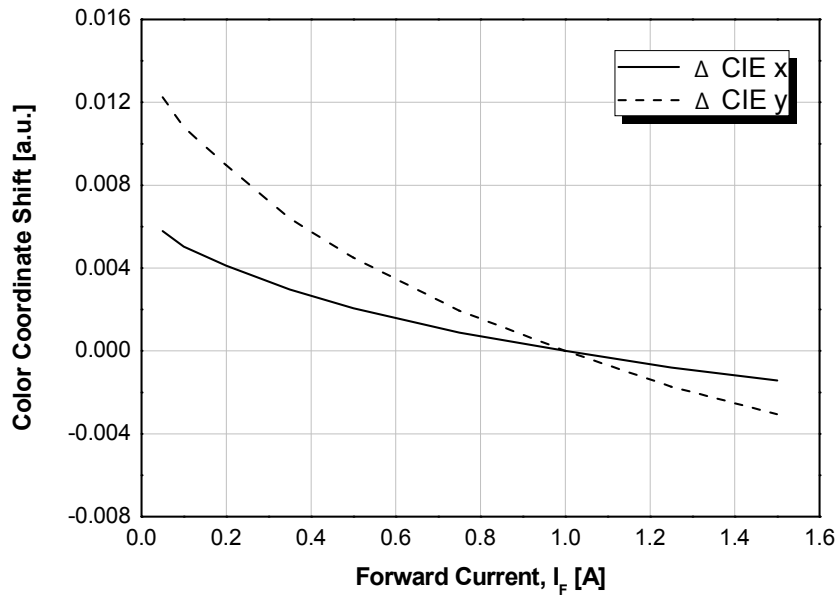


Fig 4. Forward Current vs. Relative Luminous Flux, $T_a = 25^\circ\text{C}$



Performance Characteristics

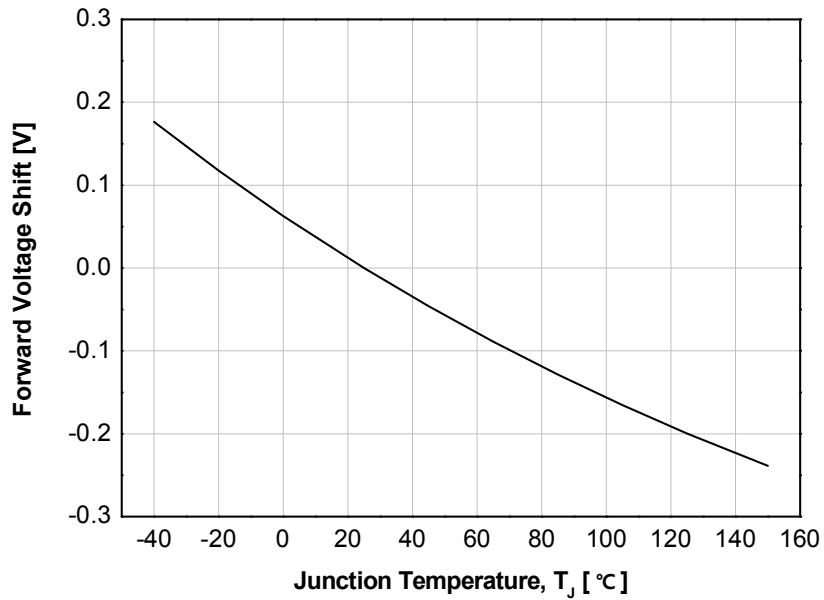
Fig 5. Forward Current vs. Color Coordinate Shift, $T_a = 25^\circ\text{C}$



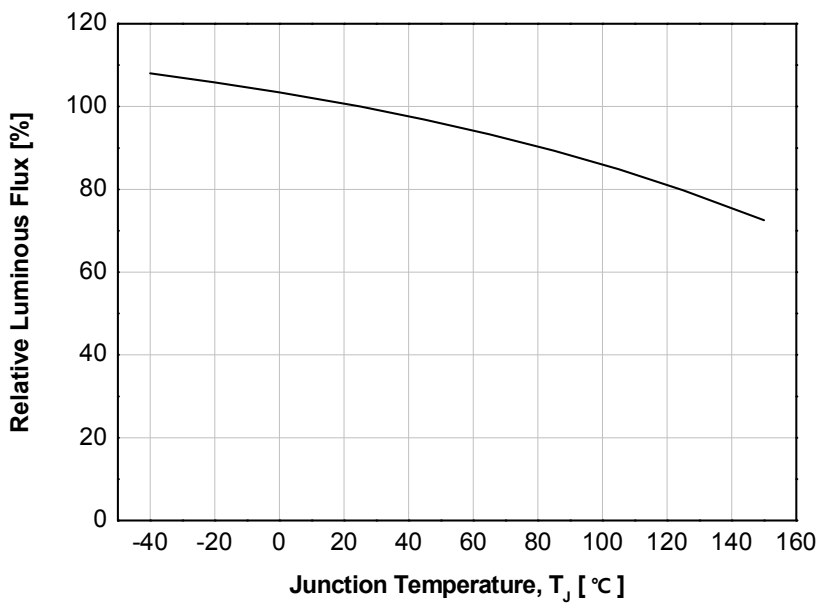
Performance Characteristics

Fig 6. Junction Temperature vs. Forward Voltage Shift, $I_F = 1.0A$

$$\Delta V_F = V_F - V_F(25^\circ C)$$

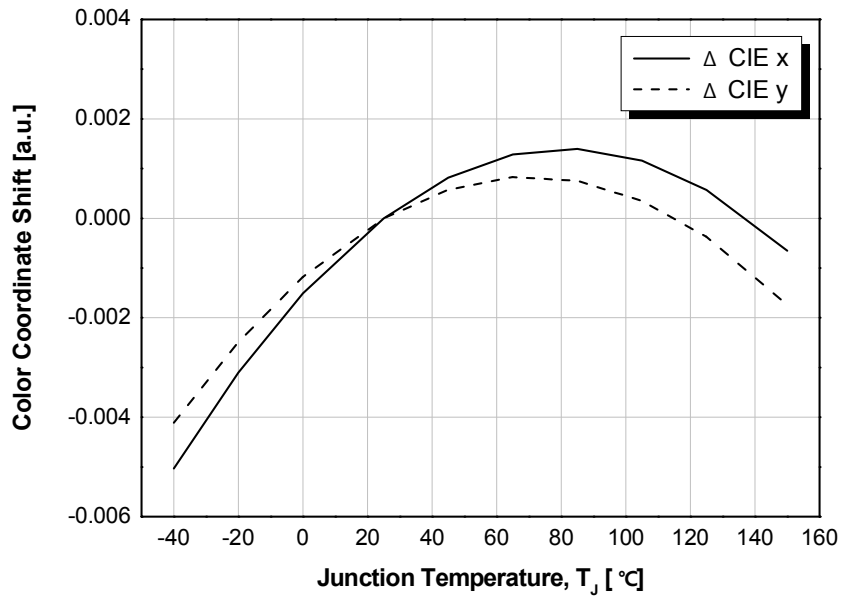

Fig 7. Junction Temperature vs. Relative Luminous Flux, $I_F = 1.0A$

$$I_v / I_v(25^\circ C)$$



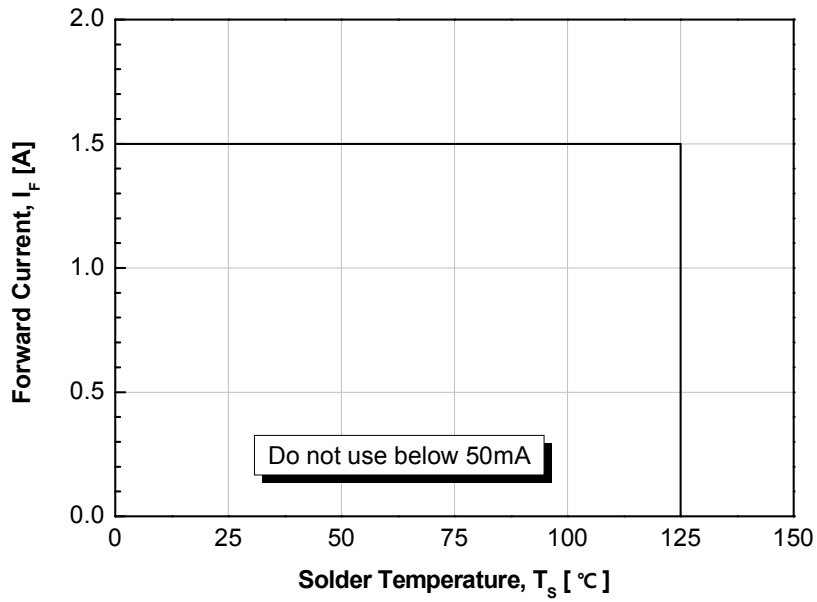
Performance Characteristics

Fig 8. Junction Temperature vs. Color Coordinate Shift, $I_F = 1.0A$



Performance Characteristics

Fig 9. Solder Temperature vs. Allowable Forward Current

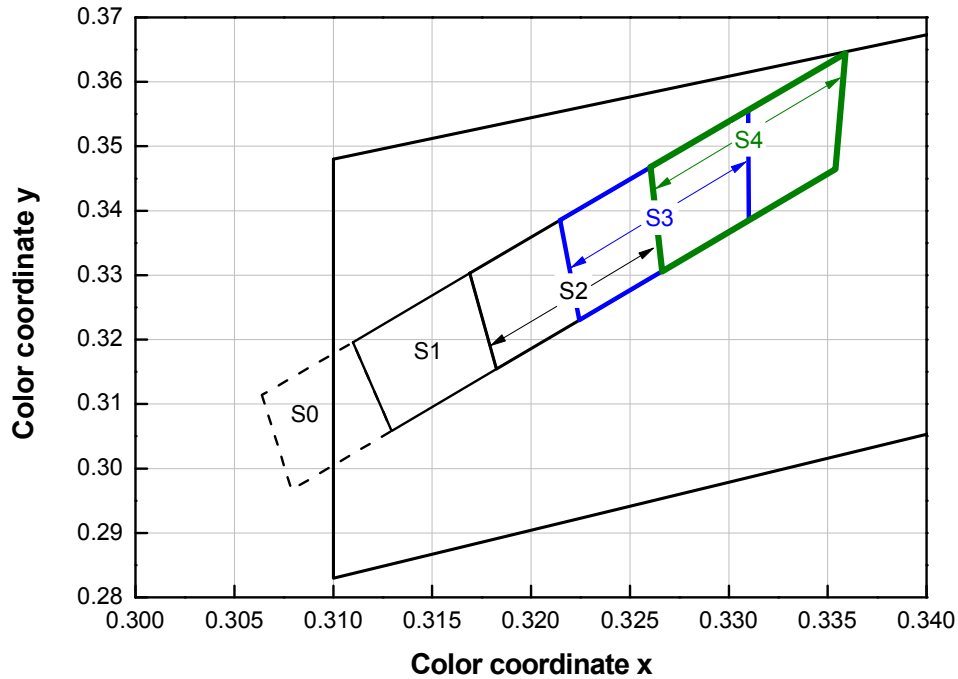


Color Bin Structure

Table 3. Bin Code Description ($T_a = 25^\circ\text{C}$, $I_F = 1.0\text{A}$)

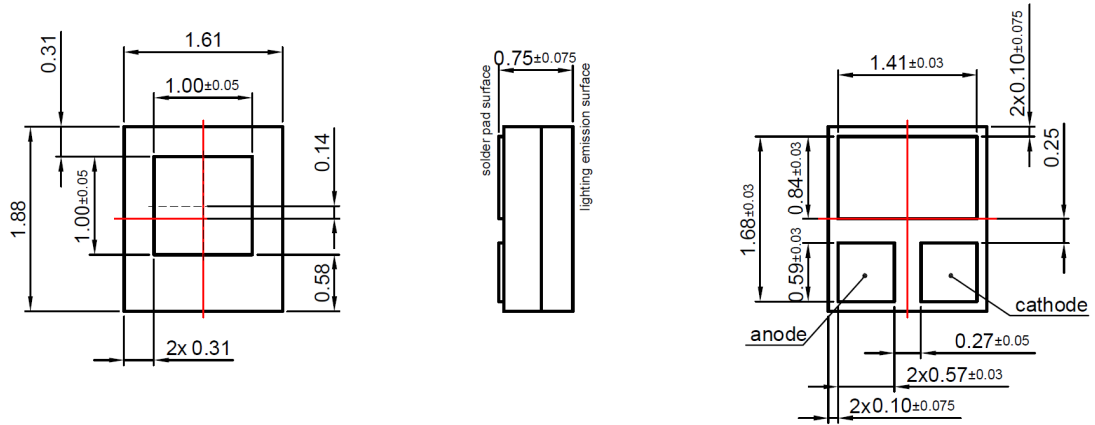
Part Number	Luminous Flux [lm]			Color Coordinate	Forward Voltage [V]		
	Bin Code	Min.	Max.		Bin Code	Min.	Max.
SWW0CS10B	2A	325	350	Refer to Page12	U1	2.80	3.00
	3A	350	375		U2	3.00	3.20
	4A	375	400		U3	3.20	3.40
					U4	3.40	3.50

Color Bin Structure

Fig 10. Color Coordinate Diagram, $T_a = 25^\circ\text{C}$, $I_F = 1.0\text{A}$


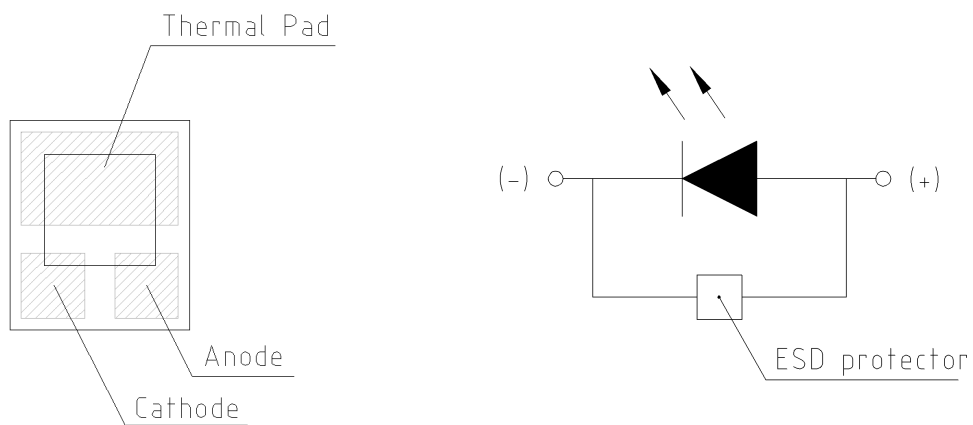
RANK	x1	y1	x2	y2
	x3	y3	x4	y4
S0	0.3064	0.3114	0.3079	0.2967
	0.3130	0.3058	0.3110	0.3196
S1	0.3110	0.3196	0.3130	0.3058
	0.3183	0.3154	0.3169	0.3303
S2	0.3169	0.3303	0.3183	0.3154
	0.3266	0.3306	0.3261	0.3468
S3	0.3215	0.3386	0.3224	0.3230
	0.3310	0.3385	0.3310	0.3556
S4	0.3261	0.3468	0.3266	0.3306
	0.3354	0.3465	0.3359	0.3644

Mechanical Dimensions



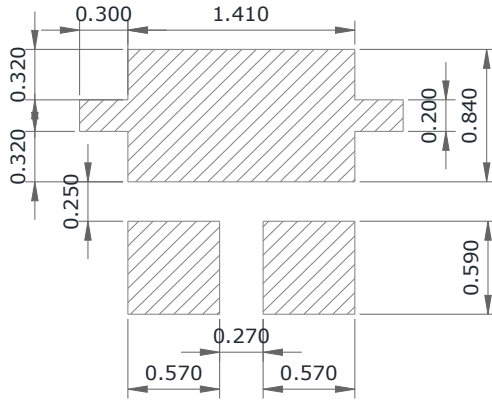
< Circuit Diagram >

(Top View)

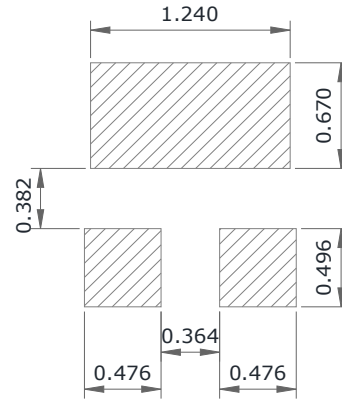


1. All dimensions are in millimeters.
2. Scale : none
3. Undefined tolerance is $\pm 0.1\text{mm}$

Recommended Solder Pad



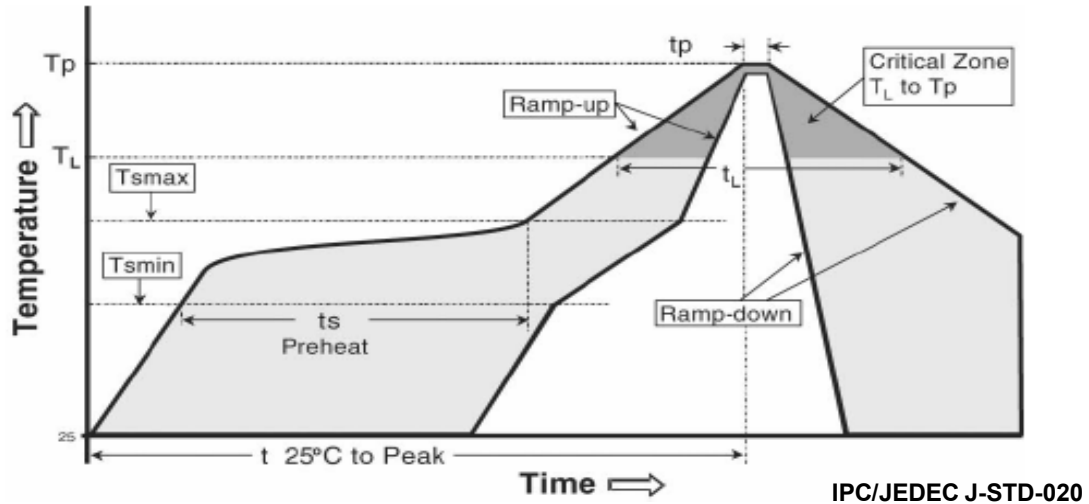
Solder Pad



Solder Metal Mask

1. All dimensions are in millimeters.
2. Scale : none
3. This drawing without tolerances are for reference only
4. Undefined tolerance is ± 0.1 mm

Reflow Soldering Characteristics

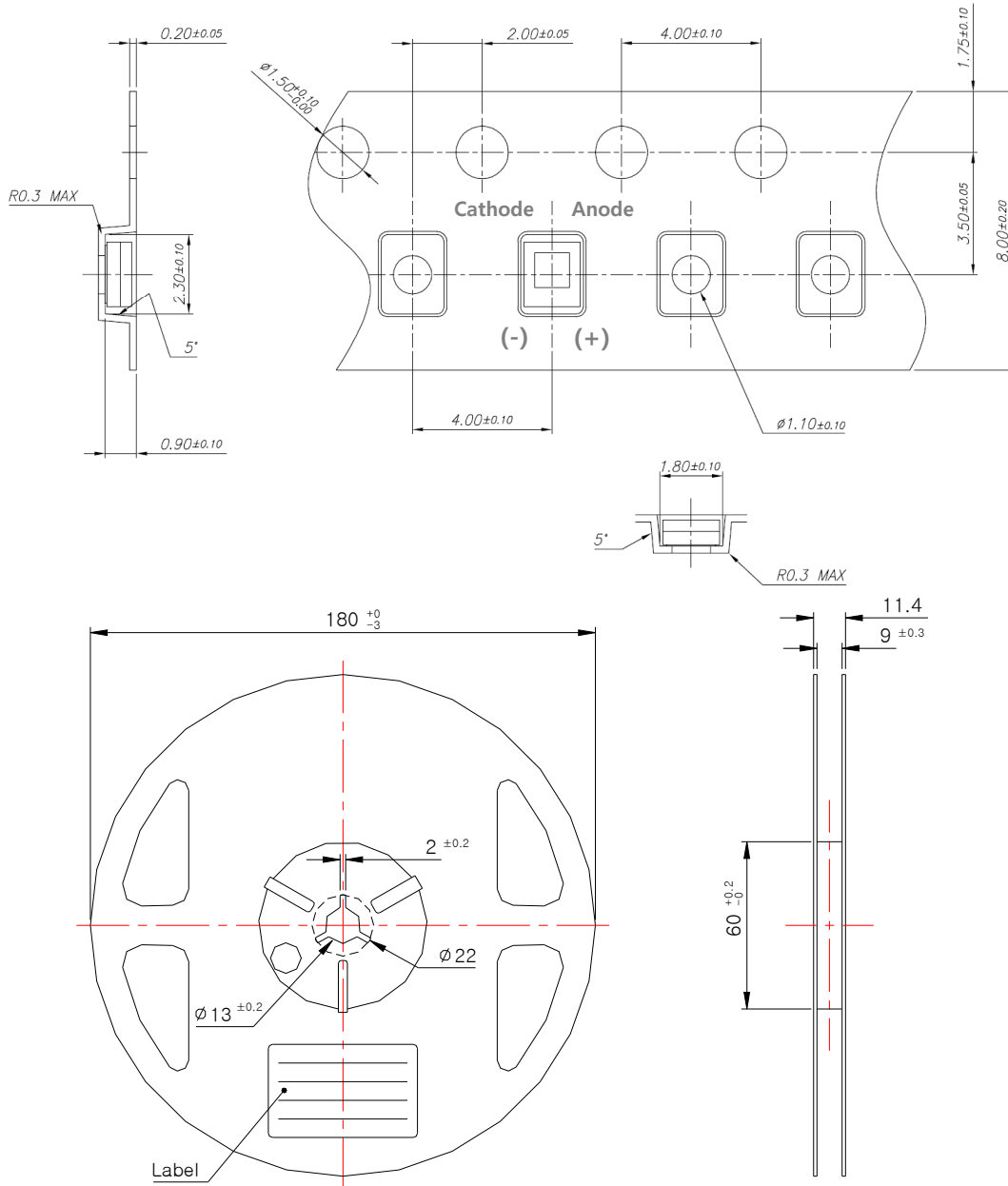


Profile Feature	Sn-Pb Eutectic Assembly	Pb-Free Assembly
Average ramp-up rate (T _{smax} to T _p)	3° C/second max.	3° C/second max.
Preheat		
- Temperature Min (T _{smin})	100 °C	150 °C
- Temperature Max (T _{smax})	150 °C	200 °C
- Time (T _{smin} to T _{smax}) (t _s)	60-120 seconds	60-180 seconds
Time maintained above:		
- Temperature (T _L)	183 °C	217 °C
- Time (t _L)	60-150 seconds	60-150 seconds
Peak Temperature (T _p)	215°C	260°C
Time within 5°C of actual Peak Temperature (t _{p2})	10-30 seconds	20-40 seconds
Ramp-down Rate	6 °C/second max.	6 °C/second max.
Time 25°C to Peak Temperature	6 minutes max.	8 minutes max.

Caution

1. Reflow soldering is recommended not to be done more than three times. In the case of more than 24 hours passed soldering after first, LEDs will be damaged.
2. Repairs should not be done after the LEDs have been soldered. When repair is unavoidable, suitable tools must be used.
3. When soldering, do not put stress on the LEDs during heating.
4. After soldering, do not warp the circuit board.

Emitter Tape & Reel Packaging

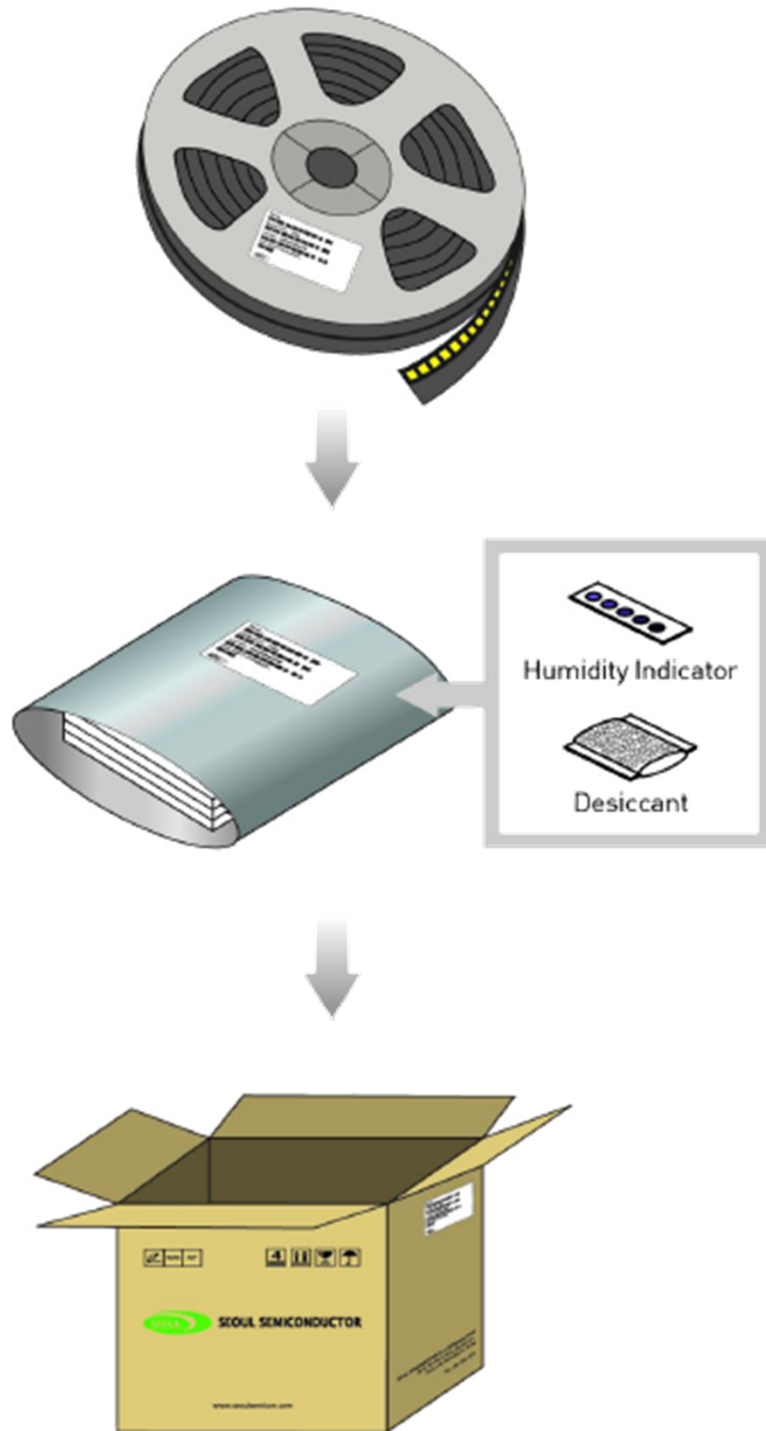


(Tolerance: ± 0.2 , Unit: mm)

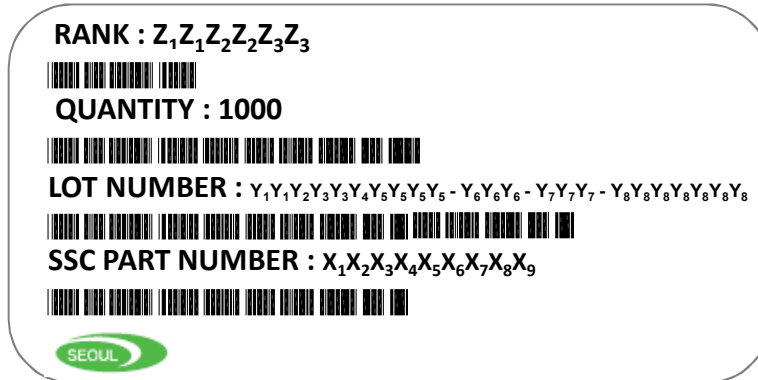
- (1) Quantity : 1000pcs/Reel
- (2) Cumulative Tolerance : Cumulative Tolerance/10 pitches to be ± 0.2 mm
- (3) Adhesion Strength of Cover Tape : Adhesion strength to be 0.1-0.7N when the cover tape is turned off from the carrier tape at the angle of 10° to the carrier tape.
- (4) Package : P/N, Manufacturing data Code No. and quantity are printed on the reel.



Emitter Tape & Reel Packaging



Product Nomenclature


Table 4. Part Numbering System : X₁X₂X₃X₄X₅X₆X₇X₈X₉

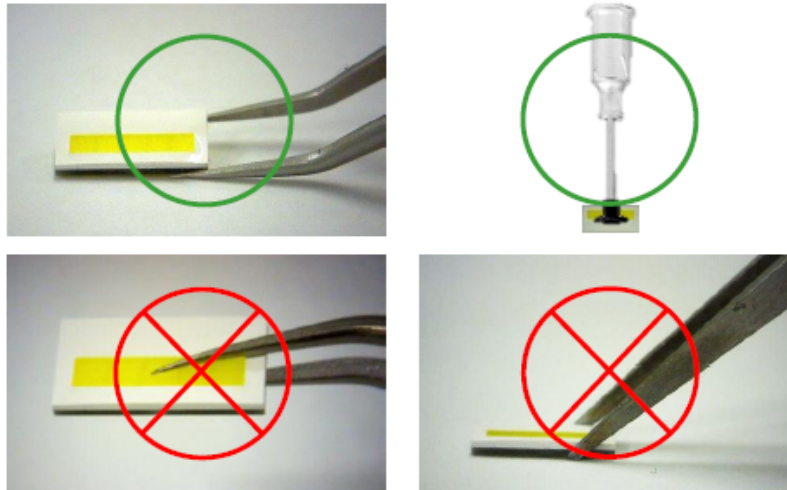
Part Number Code	Description	Part Number	Value
X ₁	Company	S	SSC
X ₂	Package Type	W	WICOP
X ₃ X ₄	Color	W0	WHITE
X ₅	Product Version	C	-
X ₆	Chip Number	S	1
X ₇ X ₈	Chip Size	10	-
X ₉	Version	B	-

Table 5. Lot Numbering System : Y₁Y₁Y₂Y₃Y₃Y₄Y₅Y₅Y₅ - Y₆Y₆Y₆ - Y₇Y₇Y₇ - Y₈Y₈Y₈Y₈Y₈

Lot Number Code	Description
Y ₁	Year
Y ₂	Month
Y ₃	Day
Y ₄	Production area
Y ₅	Mass order
Y ₆	Taping number
Y ₇	Reel number
Y ₈	Internal management number

Handling of Silicone Resin for LEDs

- (1) During processing, mechanical stress on the surface should be minimized as much as possible. Sharp objects of all types should not be used to pierce the sealing compound.



- (2) In general, LEDs should only be handled from the side. By the way, this also applies to LEDs without a silicone sealant, since the surface can also become scratched.
- (3) When populating boards in SMT production, there are basically no restrictions regarding the form of the pick and place nozzle, except that mechanical pressure on the surface of the resin must be prevented. This is assured by choosing a pick and place nozzle which is larger than the LED's reflector area.
- (4) Silicone differs from materials conventionally used for the manufacturing of LEDs. These conditions must be considered during the handling of such devices. Compared to standard encapsulants, silicone is generally softer, and the surface is more likely to attract dust. As mentioned previously, the increased sensitivity to dust requires special care during processing. In cases where a minimal level of dirt and dust particles cannot be guaranteed, a suitable cleaning solution must be applied to the surface after the soldering of components.
- (5) SSC suggests using isopropyl alcohol for cleaning. In case other solvents are used, it must be assured that these solvents do not dissolve the package or resin. Ultrasonic cleaning is not recommended. Ultrasonic cleaning may cause damage to the LED.
- (6) Please do not mold this product into another resin (epoxy, urethane, etc) and do not handle this product with acid or sulfur material in sealed space.
- (7) Avoid leaving fingerprints on silicone resin parts.

Precaution for Use

(1) Storage

To avoid the moisture penetration, we recommend storing LEDs in a dry box with a desiccant . The recommended storage temperature range is 5°C to 30°C and a maximum humidity of RH50%.

(2) Use Precaution after Opening the Packaging

Use proper SMD techniques when the LED is to be soldered dipped as separation of the lens may affect the light output efficiency.

Pay attention to the following:

a. Recommend conditions after opening the package

- Sealing / Temperature : 5 ~ 30°C Humidity : less than RH60%

b. If the package has been opened more than 1 year (MSL 2) or the color of

the desiccant changes, components should be dried for 10-24hr at 65±5°C

(3) Do not apply mechanical force or excess vibration during the cooling process to normal temperature after soldering.

(4) Do not rapidly cool device after soldering.

(5) Components should not be mounted on warped (non coplanar) portion of PCB.

(6) Radioactive exposure is not considered for the products listed here in.

(7) Gallium arsenide is used in some of the products listed in this publication. These products are dangerous if they are burned or shredded in the process of disposal. It is also dangerous to drink the liquid or inhale the gas generated by such products when chemically disposed of.

(8) This device should not be used in any type of fluid such as water, oil, organic solvent and etc. When washing is required, IPA (Isopropyl Alcohol) should be used.

(9) When the LEDs are in operation the maximum current should be decided after measuring the package temperature.

(10) LEDs must be stored in a clean environment. We recommend LEDs store in nitrogen-filled container.

(11) The appearance and specifications of the product may be modified for improvement without notice.

(12) Long time exposure of sunlight or occasional UV exposure will cause lens discoloration.

Precaution for Use

(13) VOCs (Volatile organic compounds) emitted from materials used in the construction of fixtures can penetrate silicone encapsulants of LEDs and discolor when exposed to heat and photonic energy. The result can be a significant loss of light output from the fixture. Knowledge of the properties of the materials selected to be used in the construction of fixtures can help prevent these issues.

(14) The slug is electrically isolated.

(15) Attaching LEDs, do not use adhesives that outgas organic vapor.

(16) The driving circuit must be designed to allow forward voltage only when it is ON or OFF. If the reverse voltage is applied to LED, migration can be generated resulting in LED damage.

(17) LEDs are sensitive to Electro-Static Discharge (ESD) and Electrical Over Stress (EOS). Below is a list of suggestions that Seoul Semiconductor purposes to minimize these effects.

a. ESD (Electro Static Discharge)

Electrostatic discharge (ESD) is defined as the release of static electricity when two objects come into contact. While most ESD events are considered harmless, it can be an expensive problem in many industrial environments during production and storage. The damage from ESD to LEDs may cause the product to demonstrate unusual characteristics such as:

- Increase in reverse leakage current lowered turn-on voltage
- Abnormal emissions from the LED at low current

The following recommendations are suggested to help minimize the potential for an ESD event. One or more recommended work area suggestions:

- Ionizing fan setup
- ESD table/shelf mat made of conductive materials
- ESD safe storage containers

One or more personnel suggestion options:

- Antistatic wrist-strap
- Antistatic material shoes
- Antistatic clothes

Environmental controls:

- Humidity control (ESD gets worse in a dry environment)

Precaution for Use

b. EOS (Electrical Over Stress)

Electrical Over-Stress (EOS) is defined as damage that may occur when an electronic device is subjected to a current or voltage that is beyond the maximum specification limits of the device.

The effects from an EOS event can be noticed through product performance like:

- Changes to the performance of the LED package
(If the damage is around the bond pad area and since the package is completely encapsulated the package may turn on but flicker show severe performance degradation.)
- Changes to the light output of the luminaire from component failure
- Components on the board not operating at determined drive power

Failure of performance from entire fixture due to changes in circuit voltage and current across total circuit causing trickle down failures. It is impossible to predict the failure mode of every LED exposed to electrical overstress as the failure modes have been investigated to vary, but there are some common signs that will indicate an EOS event has occurred:

- Damaged may be noticed to the bond wires (appearing similar to a blown fuse)
- Damage to the bond pads located on the emission surface of the LED package
(shadowing can be noticed around the bond pads while viewing through a microscope)
- Anomalies noticed in the encapsulation and phosphor around the bond wires.
- This damage usually appears due to the thermal stress produced during the EOS event.

c. To help minimize the damage from an EOS event Seoul Semiconductor recommends utilizing:

- A surge protection circuit
- An appropriately rated over voltage protection device
- A current limiting device



Company Information

Published by

Seoul Semiconductor © 2013 All Rights Reserved.

Company Information

Seoul Semiconductor (www.SeoulSemicon.com) manufactures and packages a wide selection of light emitting diodes (LEDs) for the automotive, general illumination/lighting, Home appliance, signage and back lighting markets. The company is the world's fifth largest LED supplier, holding more than 10,000 patents globally, while offering a wide range of LED technology and production capacity in areas such as "nPola", "Acrich", the world's first commercially produced AC LED, and "Acrich MJT - Multi-Junction Technology" a proprietary family of high-voltage LEDs.

The company's broad product portfolio includes a wide array of package and device choices such as Acrich and Acirch2, high-brightness LEDs, mid-power LEDs, side-view LEDs, and through-hole type LEDs as well as custom modules, displays, and sensors.

Legal Disclaimer

Information in this document is provided in connection with Seoul Semiconductor products. With respect to any examples or hints given herein, any typical values stated herein and/or any information regarding the application of the device, Seoul Semiconductor hereby disclaims any and all warranties and liabilities of any kind, including without limitation, warranties of non-infringement of intellectual property rights of any third party. The appearance and specifications of the product can be changed to improve the quality and/or performance without notice.

单击下面可查看定价，库存，交付和生命周期等信息

[>>Seoul Semiconductor\(首尔半导体\)](#)