

**6.0 A Single-Phase Silicon Bridge Rectifier**  
Rectifier Reverse Voltage 50 to 1000V

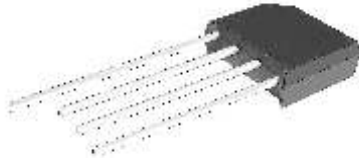

**Features**

- This series is UL listed under the Recognized Component Index, file number E142814
- Ideal for printed circuit board mounting
- The plastic material used carries Underwriters Laboratory flammability recognition 94V-0
- Built-in printed circuit board stand-offs
- High case dielectric strength
- High temperature soldering guaranteed 265°C/10 seconds at 5 lbs (2.3kg) tension

**Mechanical Data**

Case: Reliable low cost construction utilizing molded plastic technique  
 Terminals: Plated leads solderable per MIL-STD-202, Method 208  
 Mounting Position: Any  
 Weight: 0.2 ounce, 5.6 grams (approx)

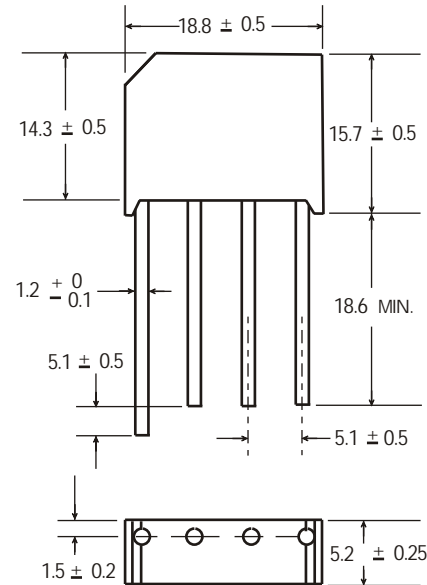

Dimensions in millimeters(1mm =0.0394")

**Maximum Ratings & Thermal Characteristics**

Rating at 25°C ambient temperature unless otherwise specified, Resistive or Inductive load, 60 Hz.  
 For Capacitive load derate current by 20%.

Parameter	Symbol	KBL 6005	KBL 601	KBL 602	KBL 604	KBL 606	KBL 608	KBL 610	unit
Maximum repetitive peak reverse voltage	VRRM	50	100	200	400	600	800	1000	V
Maximum RMS bridge input voltage	VRMS	35	70	140	280	420	560	700	V
Maximum DC blocking voltage	VDC	50	100	200	400	600	800	1000	V
Maximum average forward rectified output current at TA=50°C	IF(AV)	6.0							A
Peak forward surge current single sine-wave superimposed on rated load (JEDEC Method)	IFSM	200							A
Rating for fusing ( t<8.3ms)	I <sup>2</sup> t	166							A <sup>2</sup> sec
Typical thermal resistance per element (1)	ReJA	10.0							°C / W
Operating junction and storage temperature range	TJ, TSTG	-55 to + 150							°C

**Electrical Characteristics**

Rating at 25°C ambient temperature unless otherwise specified. Resistive or Inductive load, 60Hz.  
 For Capacitive load derate by 20 %.

Parameter	Symbol	KBL 6005	KBL 601	KBL 602	KBL 604	KBL 606	KBL 608	KBL 610	Unit
Maximum instantaneous forward voltage drop per leg at 6.0A	VF	1.1							V
Maximum DC reverse current at rated TA =25°C DC blocking voltage per element TA =125°C	IR	10 1000							µA

**Notes:** (1) Thermal resistance from Junction to Ambient on P.C.board mounting.

# Rating and Characteristic Curves ( $T_A=25^{\circ}\text{C}$ Unless otherwise noted )

## KBL6005 thru KBL610

**Fig. 1 Derating Curve for Output Rectified Current**

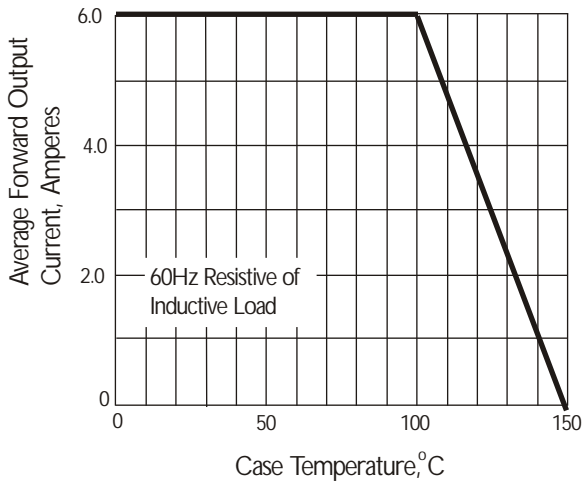

**Fig. 2 Maximum Non-repetitive Peak Forward Surge Current**

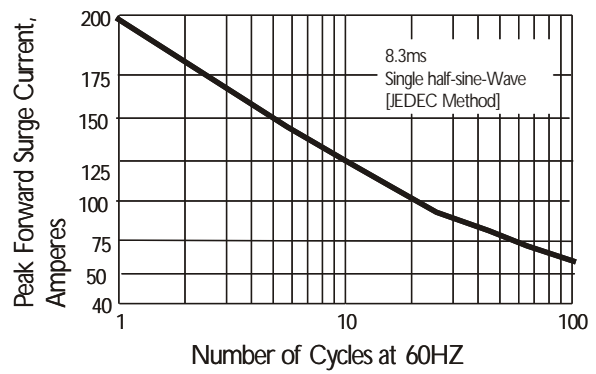

**Fig. 3 Typical Instantaneous Forward Characteristics**

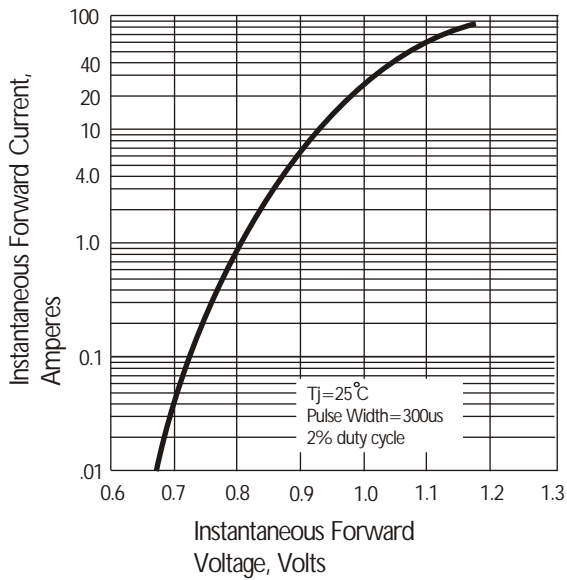

**Fig. 4 Typical Reverse Characteristics**

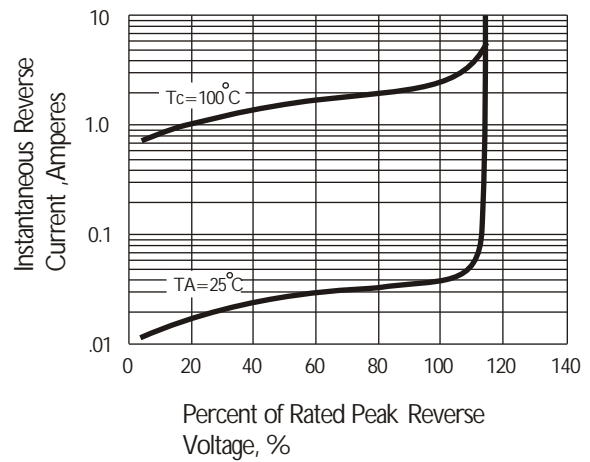

**Fig. 5 Typical Junction Capacitance**

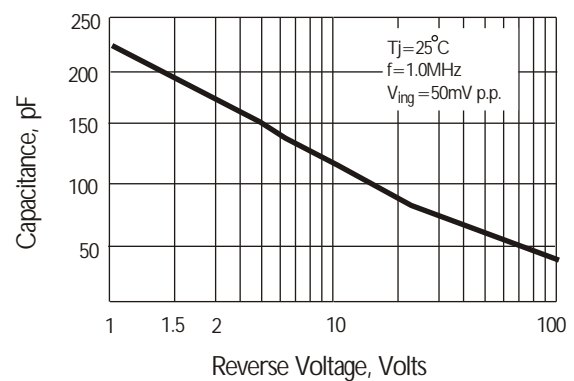

单击下面可查看定价，库存，交付和生命周期等信息

[>>SEP\(威旺\)](#)