

GENERAL DESCRIPTION

The SGM803B, SGM809B and SGM810B are integrated microprocessor supervisory devices which can be reset under power-up, power-down or even voltage reduction brownout conditions. When V_{CC} is as low as 1V, the reset output can still operate. On the power-on state, the internal timer maintains a 240ms reset assertion, which keeps the microprocessor in the reset state until the condition is stable.

The SGM803B has an active-low open-drain nRESET output. The SGM809B has an active-low push-pull nRESET output and the SGM810B has an active-high push-pull RESET output. These devices provide five reset threshold voltage options for 3V, 3.3V and 5V voltage monitoring.

The devices all have a low quiescent current of 300nA (TYP). And the glitch immunity within the reset comparator protects it from fast transients on V_{CC} .

The SGM803B, SGM809B and SGM810B are available in Green SOT-23-3 and SOT-23 packages. They operates over a junction temperature range of -40°C to +125°C.

FEATURES

- Superior Upgrade for MAX803/MAX809/MAX810 and ADM803/ADM809/ADM810
- High Accuracy Fixed Detection Options: 3V, 3.3V and 5V
- Low Supply Current: 300nA (TYP)
- 150ms (MIN) Power-on Reset Pulse Width
- Reset Output Options:
 - ♦ Open-Drain nRESET Output (SGM803B)
 - ♦ Push-Pull nRESET Output (SGM809B)
 - ♦ Push-Pull RESET Output (SGM810B)
- Reset Valid Down to $V_{CC} = 1V$
- Fully Specified over Temperature
- V_{CC} Transient Immunity
- -40°C to +125°C Operating Temperature Range
- Available in Green SOT-23-3 and SOT-23 Packages

APPLICATIONS

- Battery-Powered Applications
- Microprocessor Systems
- Portable Equipment
- Safety Systems
- Intelligent Instruments

TYPICAL APPLICATION

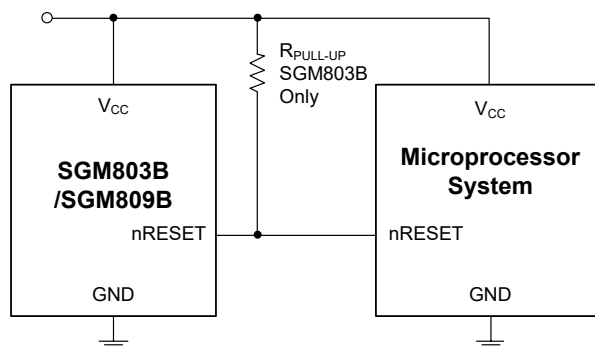

Figure 1. Typical Application Circuit

PACKAGE/ORDERING INFORMATION

MODEL	RESET THRESHOLD (V)	PACKAGE DESCRIPTION	ORDERING NUMBER	PACKAGE MARKING	PACKING OPTION
SGM803B	4.38	SOT-23-3	SGM803B-MXN3G/TR	M18XX	Tape and Reel, 3000
	4.38	SOT-23	SGM803B-MXN3LG/TR	M19XX	Tape and Reel, 3000
	4.00	SOT-23-3	SGM803B-JXN3G/TR	M1AXX	Tape and Reel, 3000
	4.00	SOT-23	SGM803B-JXN3LG/TR	M1BXX	Tape and Reel, 3000
	3.08	SOT-23-3	SGM803B-TXN3G/TR	M1CXX	Tape and Reel, 3000
	3.08	SOT-23	SGM803B-TXN3LG/TR	M1DXX	Tape and Reel, 3000
	2.93	SOT-23-3	SGM803B-SXN3G/TR	M1EXX	Tape and Reel, 3000
	2.93	SOT-23	SGM803B-SXN3LG/TR	GZ5XX	Tape and Reel, 3000
	2.63	SOT-23-3	SGM803B-RXN3G/TR	M1FXX	Tape and Reel, 3000
	2.63	SOT-23	SGM803B-RXN3LG/TR	M20XX	Tape and Reel, 3000
SGM809B	4.38	SOT-23-3	SGM809B-MXN3G/TR	M21XX	Tape and Reel, 3000
	4.38	SOT-23	SGM809B-MXN3LG/TR	M22XX	Tape and Reel, 3000
	4.00	SOT-23-3	SGM809B-JXN3G/TR	M23XX	Tape and Reel, 3000
	4.00	SOT-23	SGM809B-JXN3LG/TR	M24XX	Tape and Reel, 3000
	3.08	SOT-23-3	SGM809B-TXN3G/TR	M25XX	Tape and Reel, 3000
	3.08	SOT-23	SGM809B-TXN3LG/TR	GZ4XX	Tape and Reel, 3000
	2.93	SOT-23-3	SGM809B-SXN3G/TR	GZ0XX	Tape and Reel, 3000
	2.93	SOT-23	SGM809B-SXN3LG/TR	GYEXX	Tape and Reel, 3000
	2.63	SOT-23-3	SGM809B-RXN3G/TR	GZ2XX	Tape and Reel, 3000
	2.63	SOT-23	SGM809B-RXN3LG/TR	GZ1XX	Tape and Reel, 3000
SGM810B	4.38	SOT-23-3	SGM810B-MXN3G/TR	M26XX	Tape and Reel, 3000
	4.38	SOT-23	SGM810B-MXN3LG/TR	M27XX	Tape and Reel, 3000
	4.00	SOT-23-3	SGM810B-JXN3G/TR	M28XX	Tape and Reel, 3000
	4.00	SOT-23	SGM810B-JXN3LG/TR	M29XX	Tape and Reel, 3000
	3.08	SOT-23-3	SGM810B-TXN3G/TR	M2AXX	Tape and Reel, 3000
	3.08	SOT-23	SGM810B-TXN3LG/TR	M2BXX	Tape and Reel, 3000
	2.93	SOT-23-3	SGM810B-SXN3G/TR	M2CXX	Tape and Reel, 3000
	2.93	SOT-23	SGM810B-SXN3LG/TR	GYFXX	Tape and Reel, 3000
	2.63	SOT-23-3	SGM810B-RXN3G/TR	M2DXX	Tape and Reel, 3000
	2.63	SOT-23	SGM810B-RXN3LG/TR	GZ3XX	Tape and Reel, 3000

MARKING INFORMATION

NOTE: XX = Date Code.

SOT-23-3/SOT-23

YYY X X

Date Code - Week
 Date Code - Year
 Serial Number

Green (RoHS & HSF): SG Micro Corp defines "Green" to mean Pb-Free (RoHS compatible) and free of halogen substances. If you have additional comments or questions, please contact your SGMICRO representative directly.

ABSOLUTE MAXIMUM RATINGS

V _{CC}	-0.3V to 6V
RESET, nRESET.....	-0.3V to V _{CC} + 0.3V
Input Current, V _{CC}	20mA
Output Current, RESET, nRESET.....	20mA
Rate of Rise, V _{CC}	100V/μs
Power Dissipation, P _D @ T _A = +25°C	
SOT-23-3.....	0.4W
Package Thermal Resistance	
SOT-23-3, θ _{JA}	250°C/W
Junction Temperature.....	+150°C
Storage Temperature Range.....	-65°C to +150°C
Lead Temperature (Soldering, 10s).....	+260°C
ESD Susceptibility	
HBM.....	4000V
MM.....	400V
CDM.....	1000V

RECOMMENDED OPERATING CONDITIONS

Operating Temperature Range.....	-40°C to +125°C
----------------------------------	-----------------

OVERSTRESS CAUTION

Stresses beyond those listed in Absolute Maximum Ratings may cause permanent damage to the device. Exposure to absolute maximum rating conditions for extended periods may affect reliability. Functional operation of the device at any conditions beyond those indicated in the Recommended Operating Conditions section is not implied.

ESD SENSITIVITY CAUTION

This integrated circuit can be damaged if ESD protections are not considered carefully. SGMICRO recommends that all integrated circuits be handled with appropriate precautions. Failure to observe proper handling and installation procedures can cause damage. ESD damage can range from subtle performance degradation to complete device failure. Precision integrated circuits may be more susceptible to damage because even small parametric changes could cause the device not to meet the published specifications.

DISCLAIMER

SG Micro Corp reserves the right to make any change in circuit design, or specifications without prior notice.

PIN CONFIGURATIONS

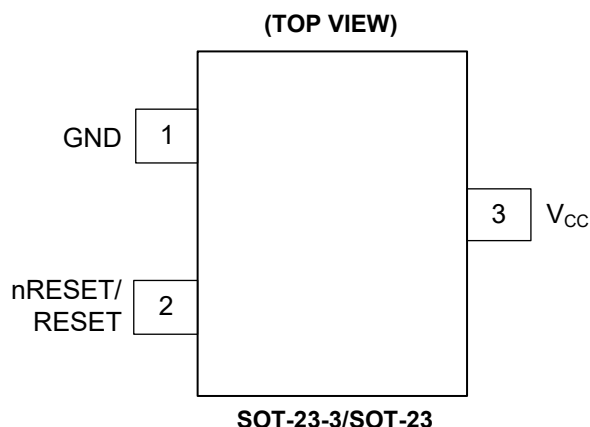

PIN DESCRIPTION

NAME	PIN NUMBER			FUNCTION
	SGM803B	SGM809B	SGM810B	
GND	1	1	1	Ground.
nRESET	2	2	—	Active-Low Reset Output Pin (SGM803B/SGM809B). If V _{CC} falls below the reset threshold, nRESET will keep low. If V _{CC} exceeds the reset threshold, the nRESET will keep low for 240ms (TYP).
RESET	—	—	2	Active-Low Reset Output Pin (SGM810B). If V _{CC} falls below the reset threshold, nRESET will keep low. If V _{CC} exceeds the reset threshold, the nRESET will keep low for 240ms (TYP).
V _{CC}	3	3	3	Supply Voltage Pin.

ELECTRICAL CHARACTERISTICS

(V_{CC} = 5V for M/J Models, 3.3V for T/S Models, 3V for R Model, unless otherwise noted.)

PARAMETER	CONDITIONS	MIN	TYP	MAX	UNITS
Supply					
Voltage	T _A = +25°C	1		5.5	V
	T _A = -40°C to +125°C	1.1		5.5	
Current	V _{CC} < 5.5V, SGM8_M/J, T _A = +25°C		420	560	nA
	V _{CC} < 5.5V, SGM8_M/J, T _A = -40°C to +125°C			730	
	V _{CC} < 3.6V, SGM8_R/S/T, T _A = +25°C		300	430	nA
	V _{CC} < 3.6V, SGM8_R/S/T, T _A = -40°C to +125°C			590	
Reset Voltage Threshold					
SGM8_M	V _{CC} falling, T _A = +25°C	4.247	4.38	4.452	V
	V _{CC} falling, T _A = -40°C to +125°C	4.217		4.482	
SGM8_J	V _{CC} falling, T _A = +25°C	3.883	4.00	4.072	V
	V _{CC} falling, T _A = -40°C to +125°C	3.859		4.101	
SGM8_T	V _{CC} falling, T _A = +25°C	3.001	3.08	3.151	V
	V _{CC} falling, T _A = -40°C to +125°C	2.966		3.181	
SGM8_S	V _{CC} falling, T _A = +25°C	2.860	2.93	2.998	V
	V _{CC} falling, T _A = -40°C to +125°C	2.841		3.018	
SGM8_R	V _{CC} falling, T _A = +25°C	2.571	2.63	2.698	V
	V _{CC} falling, T _A = -40°C to +125°C	2.525		2.745	
Hysteresis Voltage Ratio	V _{CC} rising		0.5%		
Reset Threshold Temperature Coefficient			35		ppm/°C
V _{CC} to RESET/nRESET Delay	V _{CC} falling from (V _{TH} + V _{HYS}) × (1 + 5%) to V _{TH} × (1 - 5%) ⁽¹⁾		110		µs
Reset Active Timeout Period	T _A = +25°C	150	240	370	ms
	T _A = -40°C to +125°C	120		400	
RESET/nRESET Output Voltage					
Low (SGM803B-R/S/T) Low (SGM809B-R/S/T)	V _{CC} = V _{TH(MIN)} , I _{SINK} = 1.2mA			0.3	V
Low (SGM803B-M/J) Low (SGM809B-M/J)	V _{CC} = V _{TH(MIN)} , I _{SINK} = 3.2mA			0.4	V
Low (SGM803B-R/S/T/M/J) Low (SGM809B-R/S/T/M/J)	V _{CC} > 1V, I _{SINK} = 50µA			0.3	V
High (SGM809B-R/S/T)	V _{CC} > V _{TH(MAX)} , I _{SOURCE} = 500µA	0.8 × V _{CC}			V
High (SGM809B-M/J)	V _{CC} > V _{TH(MAX)} , I _{SOURCE} = 800µA	V _{CC} - 1.5			V
Low (SGM810B-R/S/T)	V _{CC} = V _{TH(MAX)} , I _{SINK} = 1.2mA			0.3	V
Low (SGM810B-M/J)	V _{CC} = V _{TH(MAX)} , I _{SINK} = 3.2mA			0.4	V
High (SGM810B-R/S/T/M/J)	1.8V < V _{CC} < V _{TH(MIN)} , I _{SOURCE} = 150µA	0.8 × V _{CC}			V
nRESET Open-Drain Output Leakage Current (SGM803B)	V _{CC} > V _{TH} , reset de-asserted			1	µA

NOTE:

1. V_{TH} stands for reset voltage threshold and V_{HYS} stands for hysteresis voltage.

TYPICAL PERFORMANCE CHARACTERISTICS

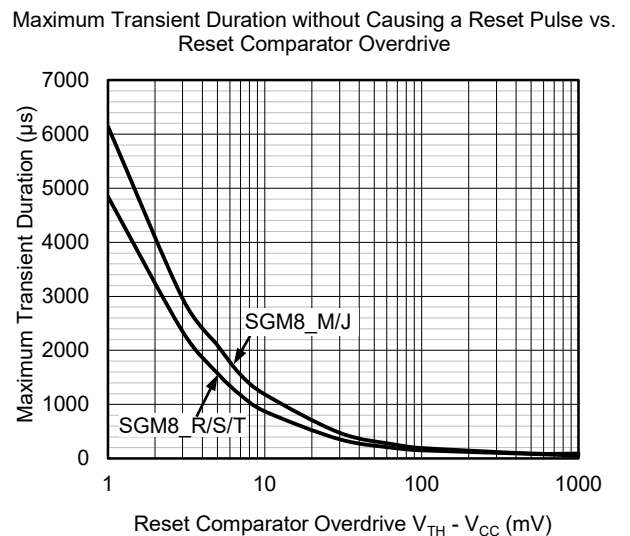
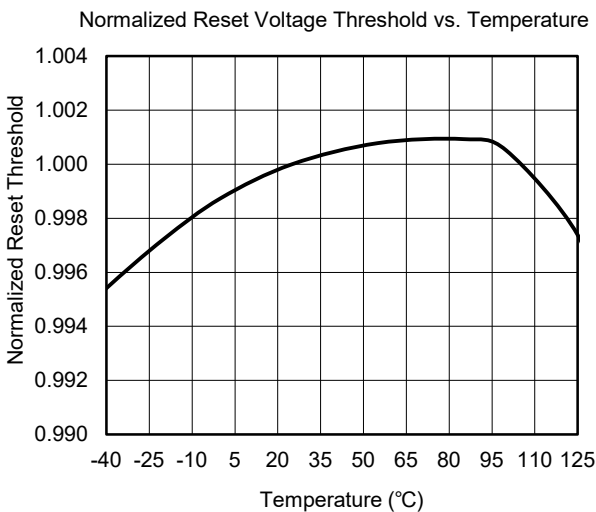
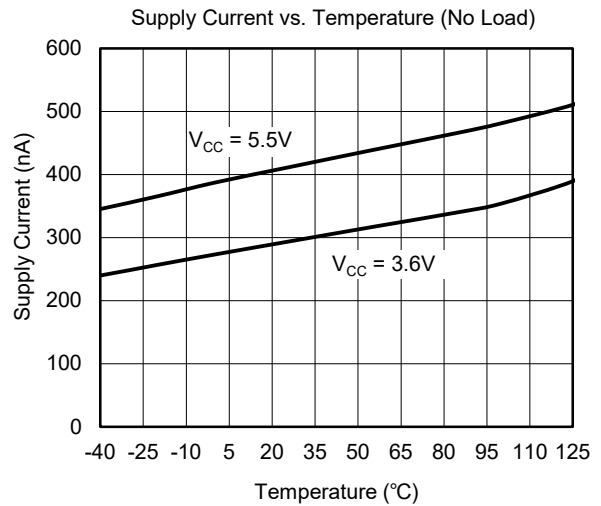
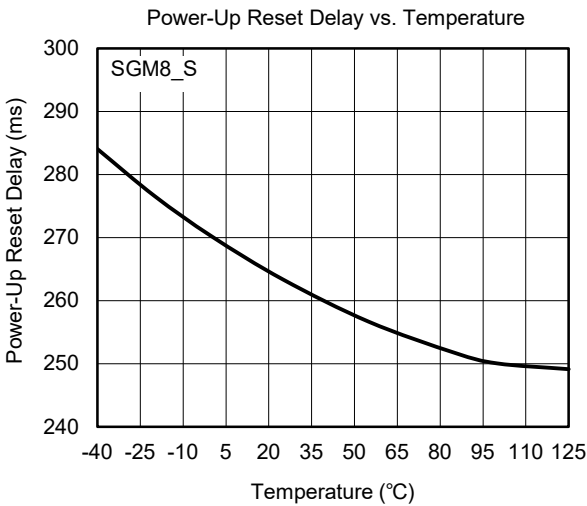
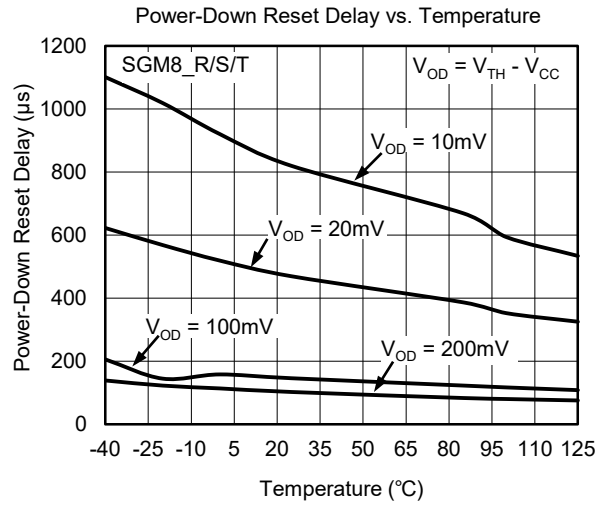
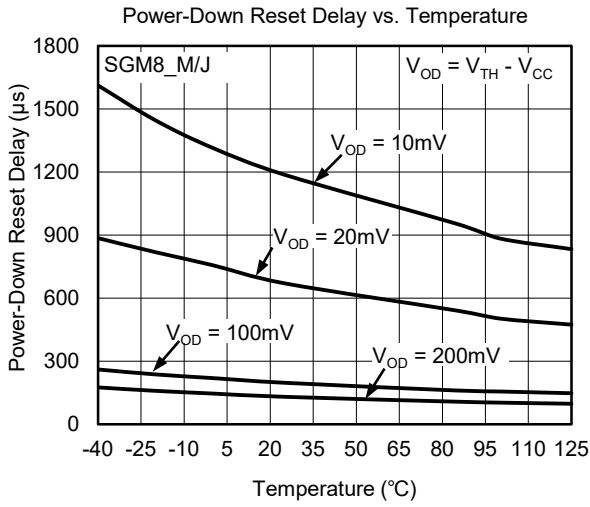

TYPICAL PERFORMANCE CHARACTERISTICS (continued)

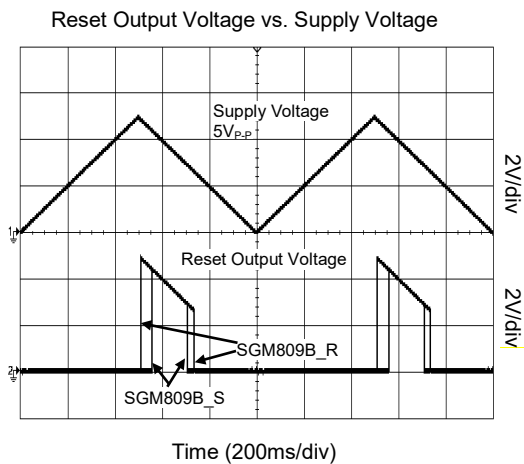

DETAILED DESCRIPTION

Reset Timing

The reset signal is asserted low for the SGM809B and high for the SGM810B when the power supply voltage falls below the threshold trip voltage and remains asserted for at least 150ms after the power supply voltage has risen above the threshold.

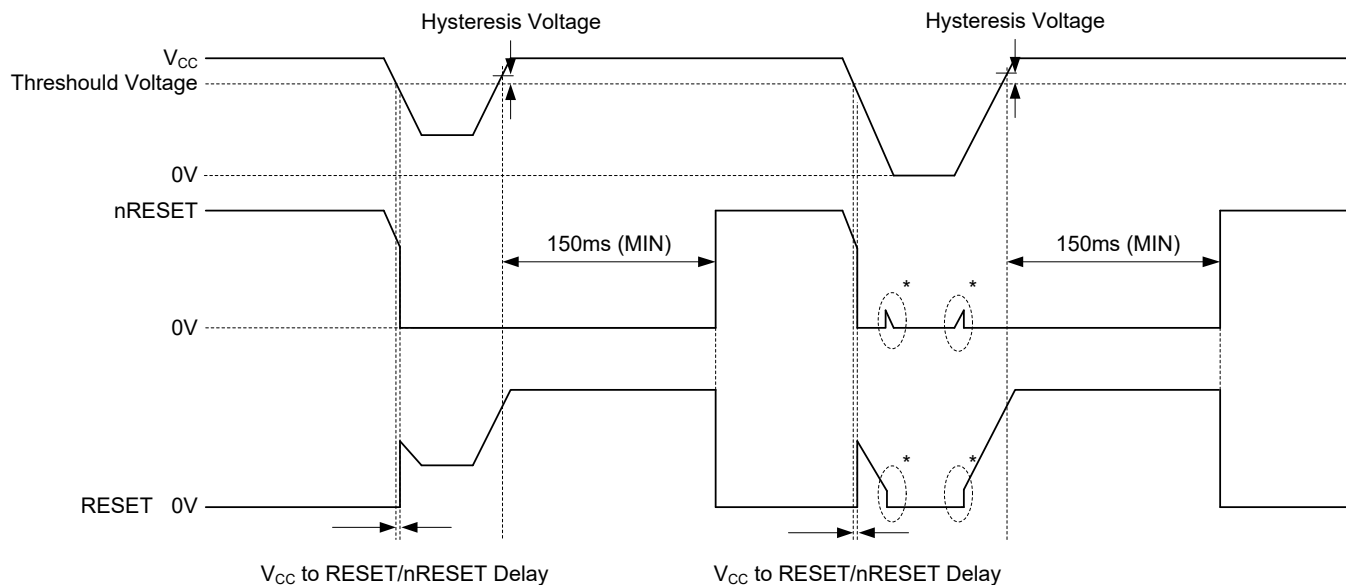

NOTE *: Undefined below minimum operating voltage.

Figure 2. Reset Timing Diagram

REVISION HISTORY

NOTE: Page numbers for previous revisions may differ from page numbers in the current version.

NOVEMBER 2019 – REV.A to REV.A.1	Page
Changed Marking Information section.....	2
<hr/>	
Changes from Original (AUGUST 2018) to REV.A	
Changed from product preview to production data.....	All

PACKAGE OUTLINE DIMENSIONS

SOT-23

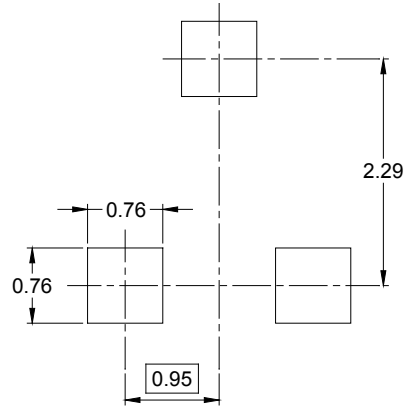
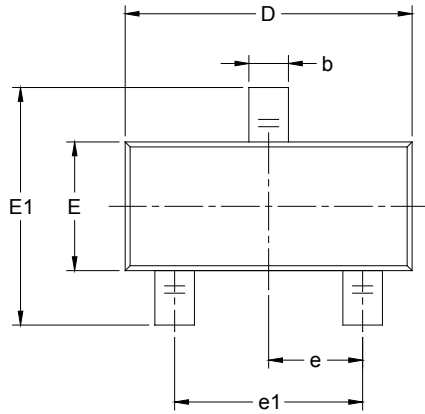

RECOMMENDED LAND PATTERN (Unit: mm)

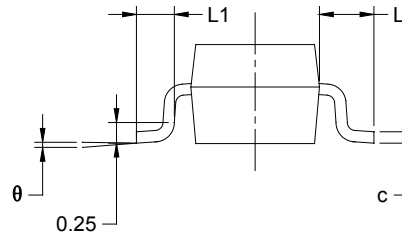
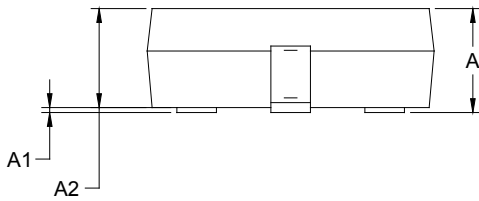

Symbol	Dimensions In Millimeters		Dimensions In Inches	
	MIN	MAX	MIN	MAX
A	0.900	1.150	0.035	0.045
A1	0.000	0.100	0.000	0.004
A2	0.900	1.050	0.035	0.041
b	0.300	0.500	0.012	0.020
c	0.080	0.150	0.003	0.006
D	2.800	3.000	0.110	0.118
E	1.200	1.400	0.047	0.055
E1	2.250	2.550	0.089	0.100
e	0.950 BSC		0.037 BSC	
e1	1.900 BSC		0.075 BSC	
L	0.550 REF		0.022 REF	
L1	0.300	0.500	0.012	0.020
θ	0°	8°	0°	8°

PACKAGE OUTLINE DIMENSIONS

SOT-23-3

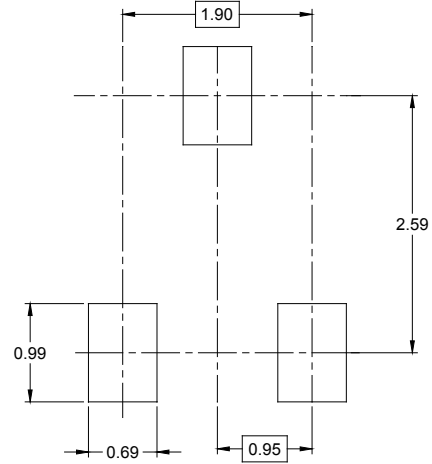
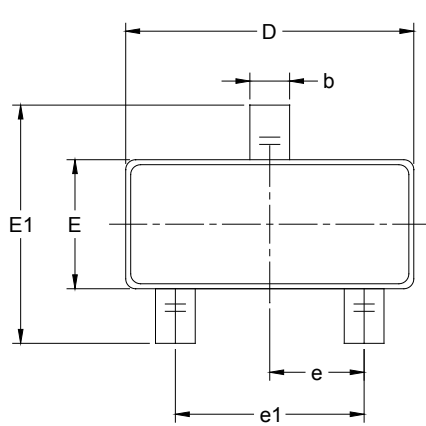

RECOMMENDED LAND PATTERN (Unit: mm)

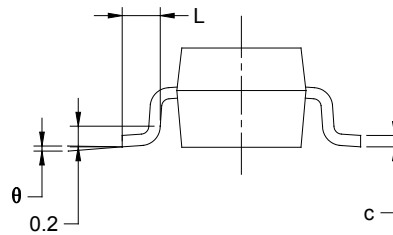
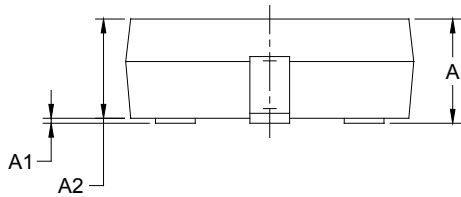

Symbol	Dimensions In Millimeters		Dimensions In Inches	
	MIN	MAX	MIN	MAX
A	1.050	1.250	0.041	0.049
A1	0.000	0.100	0.000	0.004
A2	1.050	1.150	0.041	0.045
b	0.300	0.500	0.012	0.020
c	0.100	0.200	0.004	0.008
D	2.820	3.020	0.111	0.119
E	1.500	1.700	0.059	0.067
E1	2.650	2.950	0.104	0.116
e	0.950 BSC		0.037 BSC	
e1	1.900 BSC		0.075 BSC	
L	0.300	0.600	0.012	0.024
θ	0°	8°	0°	8°

PACKAGE INFORMATION

TAPE AND REEL INFORMATION

REEL DIMENSIONS

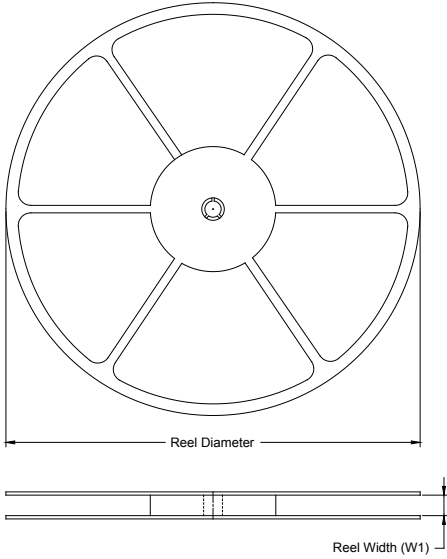

TAPE DIMENSIONS

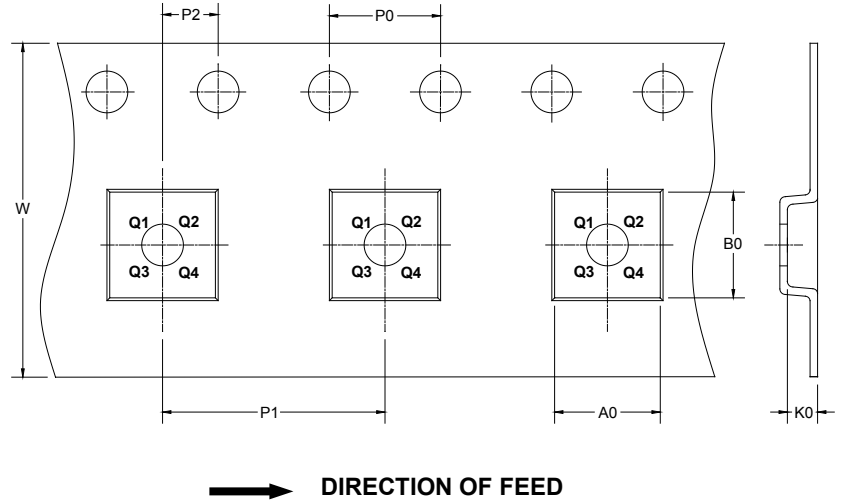

NOTE: The picture is only for reference. Please make the object as the standard.

KEY PARAMETER LIST OF TAPE AND REEL

Package Type	Reel Diameter	Reel Width W1 (mm)	A0 (mm)	B0 (mm)	K0 (mm)	P0 (mm)	P1 (mm)	P2 (mm)	W (mm)	Pin1 Quadrant
SOT-23-3	7"	9.0	3.20	3.30	1.30	4.0	4.0	2.0	8.0	Q3
SOT-23	7"	9.5	3.15	2.77	1.22	4.0	4.0	2.0	8.0	Q3

D00001

PACKAGE INFORMATION

CARTON BOX DIMENSIONS



NOTE: The picture is only for reference. Please make the object as the standard.

KEY PARAMETER LIST OF CARTON BOX

Reel Type	Length (mm)	Width (mm)	Height (mm)	Pizza/Carton
7" (Option)	368	227	224	8
7"	442	410	224	18

DD0002

单击下面可查看定价，库存，交付和生命周期等信息

[>>SGMICRO\(圣邦微电子\)](#)