

GENERAL DESCRIPTION

The SGM2045 is an ultra-low noise, low V_{IN} , high PSRR and low dropout voltage linear regulator. It is capable of supplying 300mA output current with typical dropout voltage of only 80mV. The operating input voltage range is from 1.1V to 5.5V and output voltage range is from 0.6V to 4.2V.

Other features include logic-controlled shutdown mode, short-circuit current limit and thermal shutdown protection. The SGM2045 has automatic discharge function to quickly discharge V_{OUT} in the disabled status.

The SGM2045 is suitable for applications which need low noise and fast transient response power supply, such as power supply of camera module in smart phone, etc.

The SGM2045 is available in Green XTDFN-1×1-4L and WLCSP-0.64×0.64-4B-A packages. It operates over an operating temperature range of -40°C to +125°C.

APPLICATIONS

- Portable Electronic Devices
- Smoke Detectors
- IP Cameras
- Wireless LAN Devices
- Battery-Powered Equipment
- Smartphones and Tablets
- Digital Cameras and Audio Devices

FEATURES

- **Operating Input Voltage Range: 1.1V to 5.5V**
- **Fixed Outputs of 0.6V, 0.75V, 0.8V, 0.85V, 1.0V, 1.05V, 1.1V, 1.2V, 1.3V, 1.5V, 1.75V, 1.8V, 1.825V, 2.2V, 2.5V, 2.8V, 2.9V, 3.0V, 3.3V and 4.2V**
- **300mA Output Current**
- **Output Voltage Accuracy: $\pm 1\%$ at +25°C**
- **Low Quiescent Current: 15 μ A (TYP)**
- **Low Dropout Voltage:**
 - ◆ **100mV (TYP) at 300mA when $V_{OUT} = 1.8V$ (XTDFN-1×1-4L)**
 - ◆ **80mV (TYP) at 300mA when $V_{OUT} = 1.8V$ (WLCSP-0.64×0.64-4B-A)**
- **Ultra-Low Noise: 9.5 μ V_{RMS} (TYP)**
- **High PSRR: 92dB (TYP) at 1kHz**
- **Current Limiting and Thermal Protection**
- **Excellent Load and Line Transient Responses**
- **With Output Automatic Discharge**
- **Stable with Small Case Size Ceramic Capacitors**
- **Shutdown Supply Current: 0.03 μ A (TYP)**
- **-40°C to +125°C Operating Temperature Range**
- **Available in Green XTDFN-1×1-4L and WLCSP-0.64×0.64-4B-A Packages**

TYPICAL APPLICATION

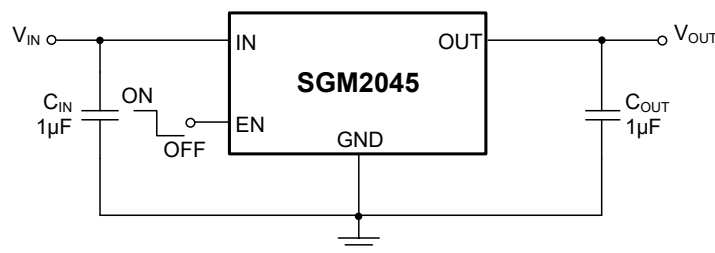

Figure 1. Typical Application Circuit

PACKAGE/ORDERING INFORMATION

MODEL	PACKAGE DESCRIPTION	SPECIFIED TEMPERATURE RANGE	ORDERING NUMBER	PACKAGE MARKING	PACKING OPTION
SGM2045-0.60	XTDFN-1×1-4L	-40°C to +125°C	SGM2045-0.60XXDH4G/TR	08	Tape and Reel, 10000
SGM2045-0.75	XTDFN-1×1-4L	-40°C to +125°C	SGM2045-0.75XXDH4G/TR	09	Tape and Reel, 10000
SGM2045-0.80	XTDFN-1×1-4L	-40°C to +125°C	SGM2045-0.80XXDH4G/TR	10	Tape and Reel, 10000
SGM2045-0.85	XTDFN-1×1-4L	-40°C to +125°C	SGM2045-0.85XXDH4G/TR	11	Tape and Reel, 10000
SGM2045-1.00	XTDFN-1×1-4L	-40°C to +125°C	SGM2045-1.00XXDH4G/TR	12	Tape and Reel, 10000
SGM2045-1.05	XTDFN-1×1-4L	-40°C to +125°C	SGM2045-1.05XXDH4G/TR	13	Tape and Reel, 10000
SGM2045-1.10	XTDFN-1×1-4L	-40°C to +125°C	SGM2045-1.10XXDH4G/TR	15	Tape and Reel, 10000
SGM2045-1.20	XTDFN-1×1-4L	-40°C to +125°C	SGM2045-1.20XXDH4G/TR	16	Tape and Reel, 10000
SGM2045-1.50	XTDFN-1×1-4L	-40°C to +125°C	SGM2045-1.50XXDH4G/TR	MC	Tape and Reel, 10000
SGM2045-1.80	XTDFN-1×1-4L	-40°C to +125°C	SGM2045-1.80XXDH4G/TR	17	Tape and Reel, 10000
SGM2045-1.825	XTDFN-1×1-4L	-40°C to +125°C	SGM2045-1.825XXDH4G/TR	2W	Tape and Reel, 10000
SGM2045-2.20	XTDFN-1×1-4L	-40°C to +125°C	SGM2045-2.20XXDH4G/TR	1Q	Tape and Reel, 10000
SGM2045-2.50	XTDFN-1×1-4L	-40°C to +125°C	SGM2045-2.50XXDH4G/TR	18	Tape and Reel, 10000
SGM2045-2.80	XTDFN-1×1-4L	-40°C to +125°C	SGM2045-2.80XXDH4G/TR	19	Tape and Reel, 10000
SGM2045-2.90	XTDFN-1×1-4L	-40°C to +125°C	SGM2045-2.90XXDH4G/TR	1P	Tape and Reel, 10000
SGM2045-3.00	XTDFN-1×1-4L	-40°C to +125°C	SGM2045-3.00XXDH4G/TR	20	Tape and Reel, 10000
SGM2045-3.30	XTDFN-1×1-4L	-40°C to +125°C	SGM2045-3.30XXDH4G/TR	21	Tape and Reel, 10000
SGM2045-4.20	XTDFN-1×1-4L	-40°C to +125°C	SGM2045-4.20XXDH4G/TR	22	Tape and Reel, 10000
SGM2045-0.60	WLCSP-0.64×0.64-4B-A	-40°C to +125°C	SGM2045-0.60XG/TR	J1	Tape and Reel, 5000
SGM2045-0.80	WLCSP-0.64×0.64-4B-A	-40°C to +125°C	SGM2045-0.80XG/TR	J2	Tape and Reel, 5000
SGM2045-0.85	WLCSP-0.64×0.64-4B-A	-40°C to +125°C	SGM2045-0.85XG/TR	J4	Tape and Reel, 5000
SGM2045-1.00	WLCSP-0.64×0.64-4B-A	-40°C to +125°C	SGM2045-1.00XG/TR	J5	Tape and Reel, 5000
SGM2045-1.05	WLCSP-0.64×0.64-4B-A	-40°C to +125°C	SGM2045-1.05XG/TR	JA	Tape and Reel, 5000
SGM2045-1.10	WLCSP-0.64×0.64-4B-A	-40°C to +125°C	SGM2045-1.10XG/TR	JD	Tape and Reel, 5000
SGM2045-1.20	WLCSP-0.64×0.64-4B-A	-40°C to +125°C	SGM2045-1.20XG/TR	K9	Tape and Reel, 5000
SGM2045-1.30	WLCSP-0.64×0.64-4B-A	-40°C to +125°C	SGM2045-1.30XG/TR	01	Tape and Reel, 5000
SGM2045-1.75	WLCSP-0.64×0.64-4B-A	-40°C to +125°C	SGM2045-1.75XG/TR	1P	Tape and Reel, 5000
SGM2045-1.80	WLCSP-0.64×0.64-4B-A	-40°C to +125°C	SGM2045-1.80XG/TR	KA	Tape and Reel, 5000
SGM2045-1.825	WLCSP-0.64×0.64-4B-A	-40°C to +125°C	SGM2045-1.825XG/TR	4N	Tape and Reel, 5000

PACKAGE/ORDERING INFORMATION (continued)

MODEL	PACKAGE DESCRIPTION	SPECIFIED TEMPERATURE RANGE	ORDERING NUMBER	PACKAGE MARKING	PACKING OPTION
SGM2045-2.50	WLCSP-0.64×0.64-4B-A	-40°C to +125°C	SGM2045-2.50XG/TR	KB	Tape and Reel, 5000
SGM2045-2.80	WLCSP-0.64×0.64-4B-A	-40°C to +125°C	SGM2045-2.80XG/TR	KD	Tape and Reel, 5000
SGM2045-2.90	WLCSP-0.64×0.64-4B-A	-40°C to +125°C	SGM2045-2.90XG/TR	00	Tape and Reel, 5000
SGM2045-3.00	WLCSP-0.64×0.64-4B-A	-40°C to +125°C	SGM2045-3.00XG/TR	KF	Tape and Reel, 5000
SGM2045-3.30	WLCSP-0.64×0.64-4B-A	-40°C to +125°C	SGM2045-3.30XG/TR	L2	Tape and Reel, 5000
SGM2045-4.20	WLCSP-0.64×0.64-4B-A	-40°C to +125°C	SGM2045-4.20XG/TR	L4	Tape and Reel, 5000

MARKING INFORMATION

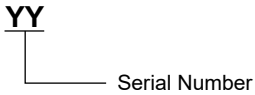

Green (RoHS & HSF): SG Micro Corp defines "Green" to mean Pb-Free (RoHS compatible) and free of halogen substances. If you have additional comments or questions, please contact your SGMICRO representative directly.

ABSOLUTE MAXIMUM RATINGS

- IN to GND -0.3V to 6V
- EN to GND -0.3V to 6V
- OUT to GND -0.3V to ($V_{IN} + 0.3V$)
- Package Thermal Resistance
- XTDFN-1×1-4L, θ_{JA} 242°C/W
- XTDFN-1×1-4L, θ_{JB} 107°C/W
- XTDFN-1×1-4L, θ_{JC} 238°C/W
- WLCSP-0.64×0.64-4B-A, θ_{JA} 285°C/W
- WLCSP-0.64×0.64-4B-A, θ_{JB} 50°C/W
- WLCSP-0.64×0.64-4B-A, θ_{JC} 116°C/W
- Junction Temperature +150°C
- Storage Temperature Range -65°C to +150°C
- Lead Temperature (Soldering, 10s) +260°C
- ESD Susceptibility
- HBM 8000V
- CDM 1000V

RECOMMENDED OPERATING CONDITIONS

- Input Voltage Range 1.1V to 5.5V
- Enable Input Voltage Range 0V to 5.5V
- Input Effective Capacitance, C_{IN} 0.1µF (MIN)
- Output Effective Capacitance, C_{OUT} 0.5µF to 200µF ⁽¹⁾
- Operating Junction Temperature Range -40°C to +125°C

NOTE:

1. To maintain a 100µA minimum output current when the output effective capacitance is more than 10µF.

OVERSTRESS CAUTION

Stresses beyond those listed in Absolute Maximum Ratings may cause permanent damage to the device. Exposure to absolute maximum rating conditions for extended periods may affect reliability. Functional operation of the device at any conditions beyond those indicated in the Recommended Operating Conditions section is not implied.

ESD SENSITIVITY CAUTION

This integrated circuit can be damaged if ESD protections are not considered carefully. SGMICRO recommends that all integrated circuits be handled with appropriate precautions. Failure to observe proper handling and installation procedures can cause damage. ESD damage can range from subtle performance degradation to complete device failure. Precision integrated circuits may be more susceptible to damage because even small parametric changes could cause the device not to meet the published specifications.

DISCLAIMER

SG Micro Corp reserves the right to make any change in circuit design, or specifications without prior notice.

PIN CONFIGURATIONS

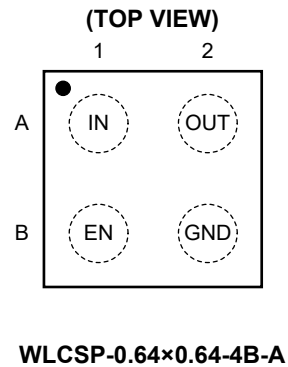
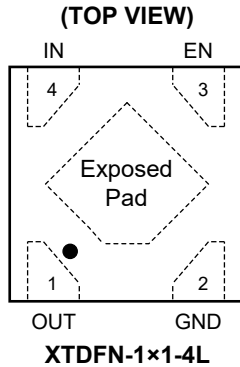

PIN DESCRIPTION

PIN		NAME	FUNCTION
XTDNFN-1x1-4L	WLCSP-0.64x0.64-4B-A		
1	A2	OUT	Regulator Output Pin. It is recommended to use a ceramic capacitor with effective capacitance in the range of 0.5 μ F to 200 μ F to ensure stability. This ceramic capacitor should be placed as close as possible to OUT pin.
2	B2	GND	Ground.
3	B1	EN	Enable Pin. Drive EN high to turn on the regulator. Drive EN low to turn off the regulator. The EN pin has an internal 0.03 μ A pull-down current source. This pin must be connected to IN pin if enable functionality is not used.
4	A1	IN	Input Supply Voltage Pin. It is recommended to use a 1 μ F or larger ceramic capacitor from IN pin to ground to get good power supply decoupling. This ceramic capacitor should be placed as close as possible to IN pin.
Exposed Pad	—	—	Exposed Pad. Connect it to a large ground plane to maximize thermal performance; this pad is not an electrical connection point.

ELECTRICAL CHARACTERISTICS

($V_{IN} = (V_{OUT(NOM)} + 0.3V)$ or 1.1V (whichever is greater), $V_{EN} = V_{IN}$, $C_{IN} = C_{OUT} = 1\mu F$, $T_J = -40^\circ C$ to $+125^\circ C$, typical values are at $T_J = +25^\circ C$, unless otherwise noted.)

PARAMETER	SYMBOL	CONDITIONS	MIN	TYP	MAX	UNITS
Input Voltage Range	V_{IN}	$I_{OUT} = 60mA$	1.1		5.5	V
		$I_{OUT} = 100mA$	1.2		5.5	
		$I_{OUT} = 200mA$	1.3		5.5	
		$I_{OUT} = 300mA$	1.4		5.5	
Output Voltage Accuracy	V_{OUT}	$I_{OUT} = 0.1mA$, $V_{OUT(NOM)} < 1.2V$, $T_J = +25^\circ C$	-12		12	mV
		$I_{OUT} = 0.1mA$ to $300mA$, $V_{IN} = (V_{OUT(NOM)} + 0.3V)$ to $5.5V$, $V_{OUT(NOM)} < 1.2V$, $T_J = -40^\circ C$ to $+125^\circ C$	-30		30	
		$I_{OUT} = 0.1mA$, $V_{OUT(NOM)} \geq 1.2V$, $T_J = +25^\circ C$	-1		1	%
		$I_{OUT} = 0.1mA$ to $300mA$, $V_{IN} = (V_{OUT(NOM)} + 0.3V)$ to $5.5V$, $V_{OUT(NOM)} \geq 1.2V$, $T_J = -40^\circ C$ to $+125^\circ C$	-2.5		2.5	
Line Regulation	ΔV_{LNR}	$V_{IN} = (V_{OUT(NOM)} + 0.3V)$ to $5.5V$, $I_{OUT} = 0.1mA$		0.05	2.5	mV
Load Regulation	$\Delta V_{LDR}/V_{OUT}$	$I_{OUT} = 0.1mA$ to $300mA$		0.4	10	mV/V
Dropout Voltage ⁽¹⁾	V_{DROP}	$I_{OUT} = 60mA$	$1.05V \leq V_{OUT(NOM)} < 1.2V$	65	110	mV
			$1.05V \leq V_{OUT(NOM)} < 1.2V$	100	160	
		$I_{OUT} = 100mA$	$1.2V \leq V_{OUT(NOM)} < 1.5V$	65	110	
			$1.05V \leq V_{OUT(NOM)} < 1.2V$	185	260	
		$I_{OUT} = 200mA$	$1.2V \leq V_{OUT(NOM)} < 1.5V$	125	210	
			$1.05V \leq V_{OUT(NOM)} < 1.2V$	260	360	
		$I_{OUT} = 300mA$	$1.2V \leq V_{OUT(NOM)} < 1.5V$	185	300	
			$1.5V \leq V_{OUT(NOM)} < 1.8V$	125	220	
			$1.8V \leq V_{OUT(NOM)} < 2.8V$	100	190	
		$I_{OUT} = 300mA$, XTDFN-1×1-4L	$2.8V \leq V_{OUT(NOM)} \leq 4.2V$	70	150	
$1.8V \leq V_{OUT(NOM)} < 2.8V$	80		130			
$I_{OUT} = 300mA$, WLCSP-0.64×0.64-4B-A	$2.8V \leq V_{OUT(NOM)} \leq 4.2V$	50	120			
	$1.8V \leq V_{OUT(NOM)} < 2.8V$	260	360			
Output Current Limit	I_{LIMIT}	$V_{OUT} = 90\% \times V_{OUT(NOM)}$, $V_{IN} = (V_{OUT(NOM)} + 0.3V)$ or 1.4V	$T_J = -20^\circ C$ to $+125^\circ C$ $T_J = -40^\circ C$ to $+125^\circ C$	300 260	600 600	mA
Short-Circuit Current	I_{SHORT}	$V_{OUT} = 0V$		380		mA
Quiescent Current	I_Q	$I_{OUT} = 0mA$		15	40	μA
Shutdown Supply Current	I_{SHDN}	$V_{EN} = 0V$, $V_{IN} = 5.5V$		0.03	2	μA
EN Input Threshold Voltage	V_{IH}	$V_{IN} = 1.1V$ to $5.5V$	0.7			V
	V_{IL}				0.3	
EN Pull-Down Current	I_{EN}	$V_{EN} = 5.5V$, $V_{IN} = 5.5V$		0.03	1	μA
Output Discharge Resistance	R_{DIS}	$V_{EN} = 0V$, $V_{OUT} = 0.2V$, $V_{IN} = 3.3V$		60		Ω
Turn-On Time	t_{ON}	From EN rising from 0V to V_{IN} to $90\% \times V_{OUT(NOM)}$, no load		100	240	μs
Power Supply Rejection Ratio	PSRR	$I_{OUT} = 20mA$, $V_{OUT(NOM)} = 1.8V$, $V_{IN} = 2.8V$	$f = 100Hz$	90		dB
			$f = 1kHz$	92		
			$f = 10kHz$	80		
			$f = 100kHz$	53		
Output Voltage Noise	e_n	$f = 10Hz$ to $100kHz$, $I_{OUT} = 20mA$, $V_{OUT(NOM)} = 1.8V$		9.5		μV_{RMS}
Thermal Shutdown Temperature	T_{SHDN}			160		$^\circ C$
Thermal Shutdown Hysteresis	ΔT_{SHDN}			20		$^\circ C$

NOTE:

1. The dropout voltage is defined as the difference between V_{IN} and V_{OUT} when V_{OUT} falls to $(V_{OUT(NOM)} - 50mV)$.

TYPICAL PERFORMANCE CHARACTERISTICS

$T_J = +25^\circ\text{C}$, $V_{IN} = (V_{OUT(NOM)} + 0.3\text{V})$ or 1.1V (whichever is greater), $V_{EN} = V_{IN}$, $C_{IN} = C_{OUT} = 1\mu\text{F}$, unless otherwise noted.

Line Transient Response

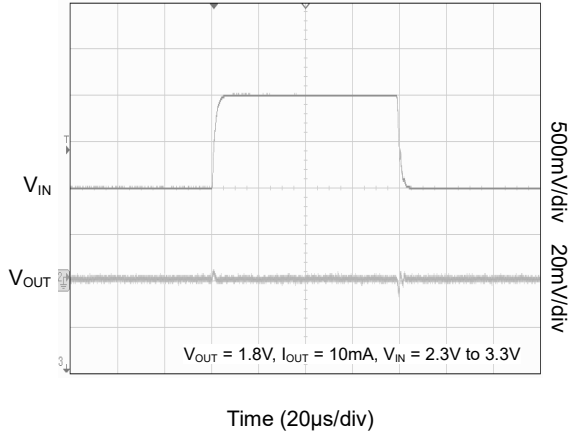

Line Transient Response

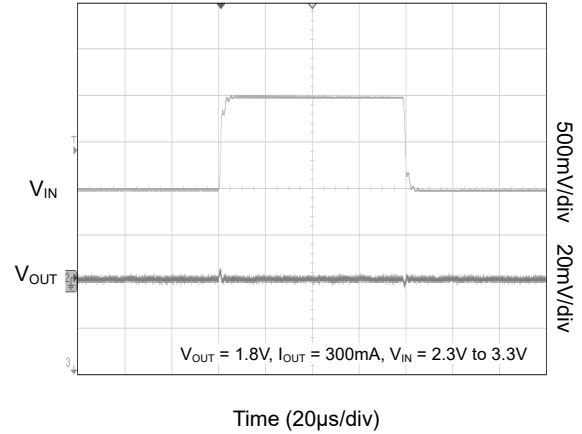

Load Transient Response

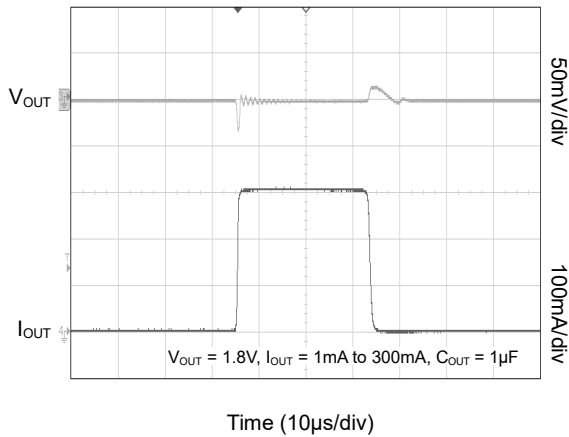

Load Transient Response

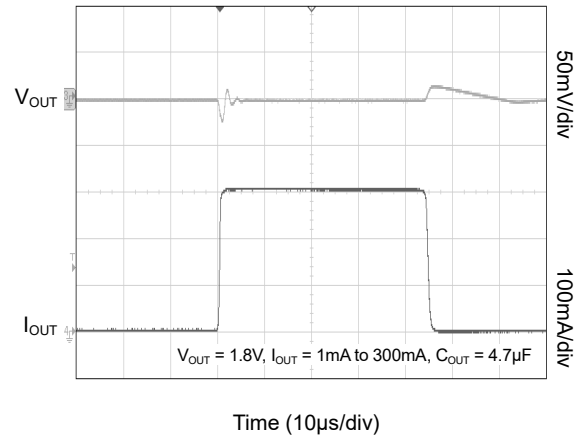

Line Transient Response

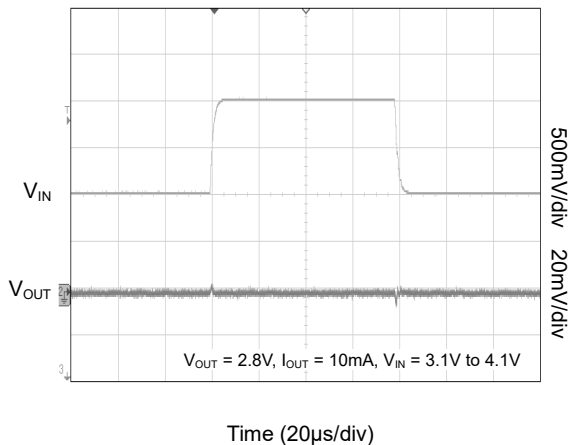

Line Transient Response

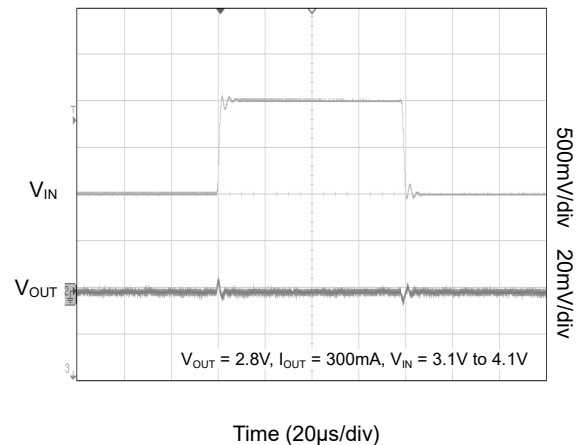

TYPICAL PERFORMANCE CHARACTERISTICS (continued)

$T_J = +25^\circ\text{C}$, $V_{IN} = (V_{OUT(NOM)} + 0.3\text{V})$ or 1.1V (whichever is greater), $V_{EN} = V_{IN}$, $C_{IN} = C_{OUT} = 1\mu\text{F}$, unless otherwise noted.

Load Transient Response

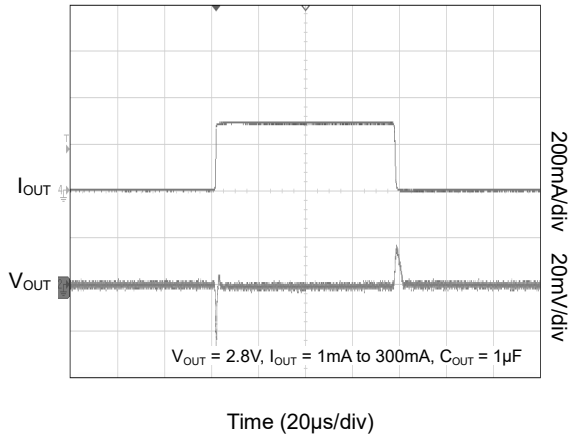

Load Transient Response

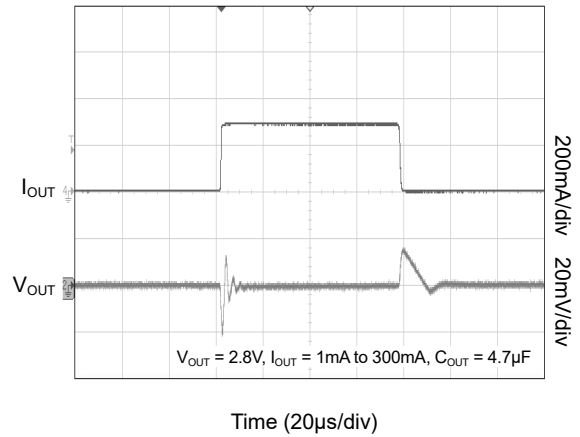

Power Supply Rejection Ratio vs. Frequency

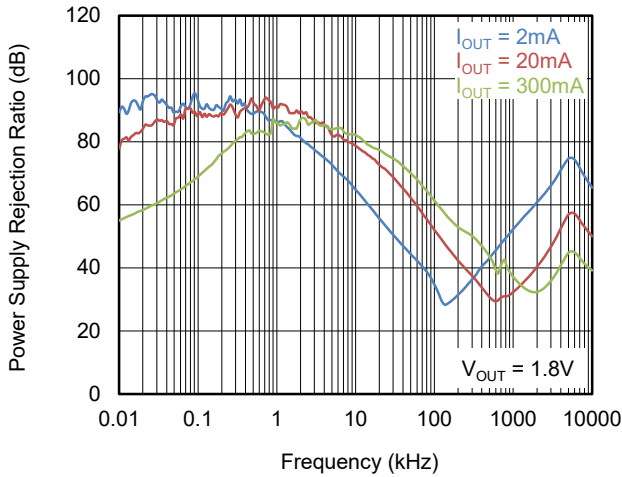

Power Supply Rejection Ratio vs. Frequency

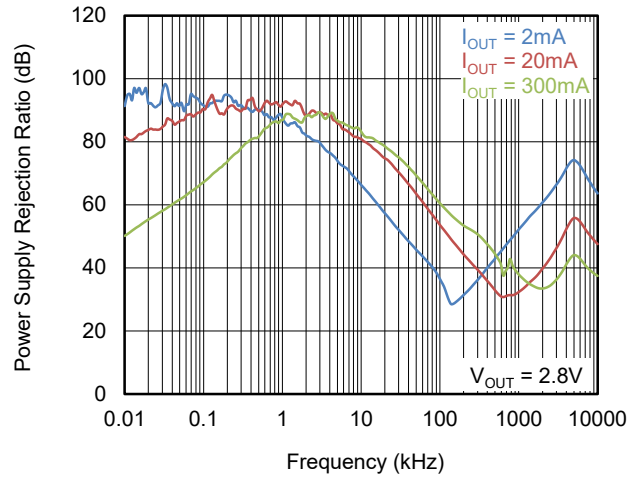

Output Noise Density vs. Frequency

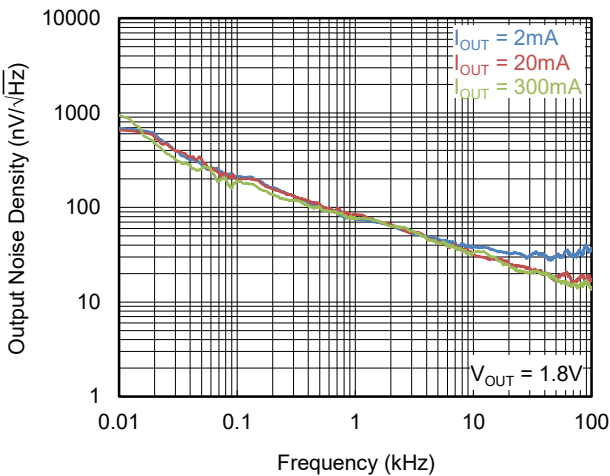

Output Noise Density vs. Frequency

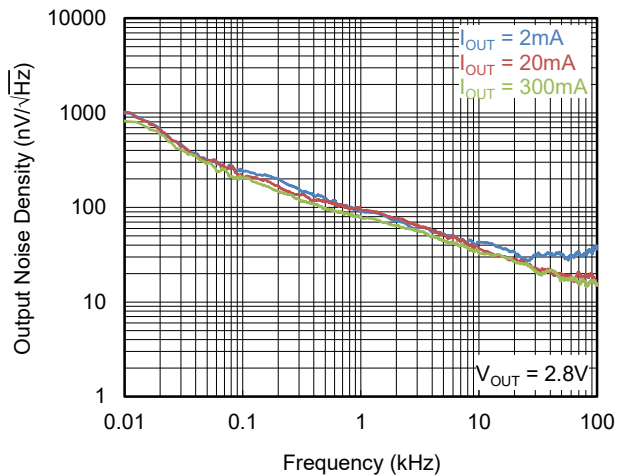

TYPICAL PERFORMANCE CHARACTERISTICS (continued)

$T_J = +25^\circ\text{C}$, $V_{IN} = (V_{OUT(NOM)} + 0.3\text{V})$ or 1.1V (whichever is greater), $V_{EN} = V_{IN}$, $C_{IN} = C_{OUT} = 1\mu\text{F}$, unless otherwise noted.

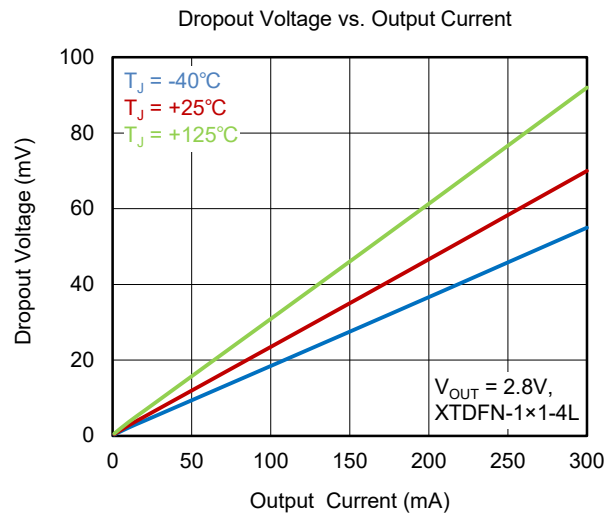
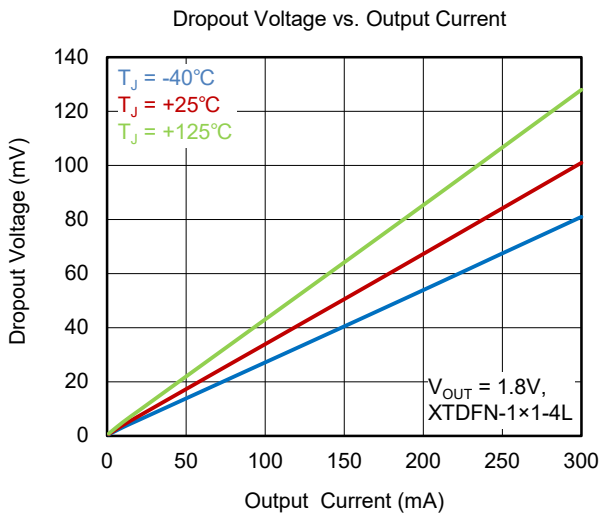
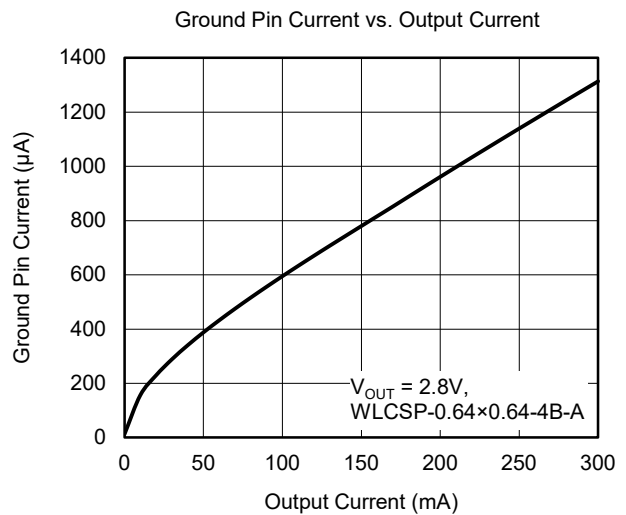
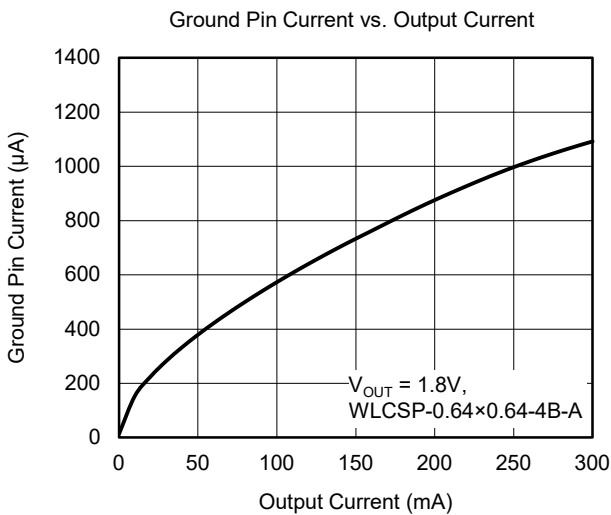
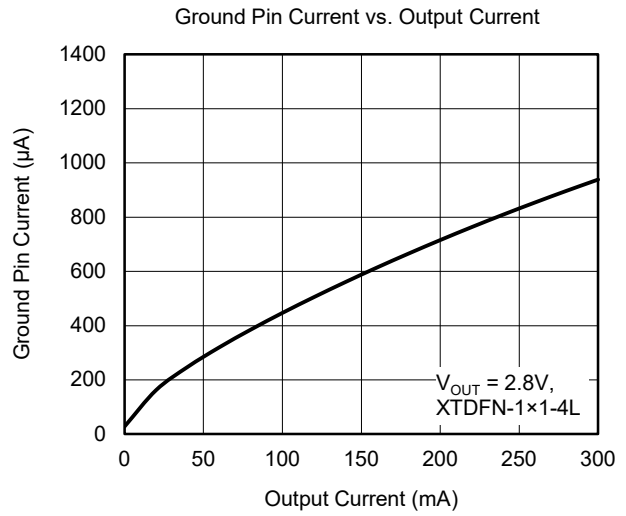
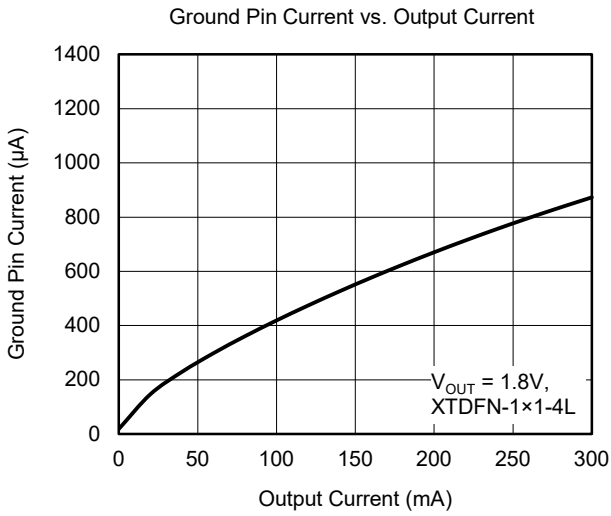

TYPICAL PERFORMANCE CHARACTERISTICS (continued)

$T_J = +25^\circ\text{C}$, $V_{IN} = (V_{OUT(NOM)} + 0.3\text{V})$ or 1.1V (whichever is greater), $V_{EN} = V_{IN}$, $C_{IN} = C_{OUT} = 1\mu\text{F}$, unless otherwise noted.

Dropout Voltage vs. Output Current

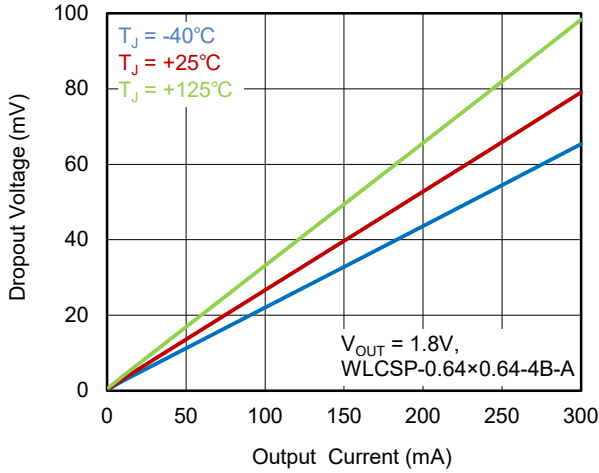

Dropout Voltage vs. Output Current

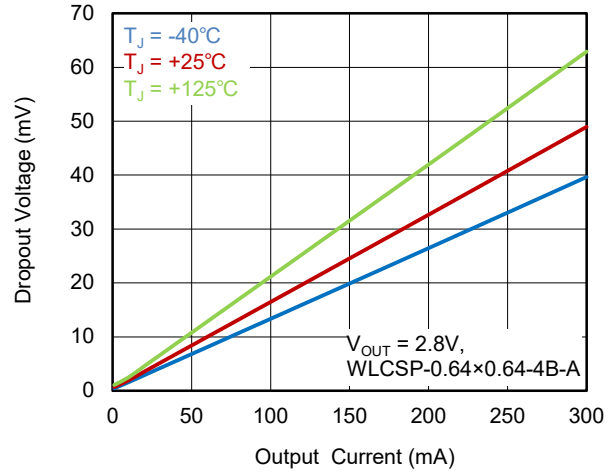

Dropout Voltage vs. Temperature

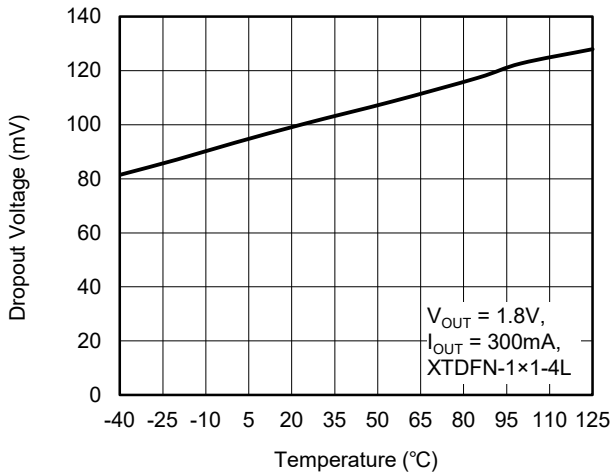

Dropout Voltage vs. Temperature

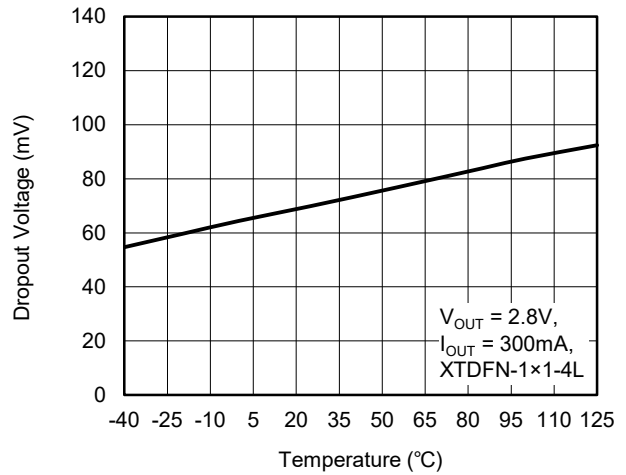

Dropout Voltage vs. Temperature

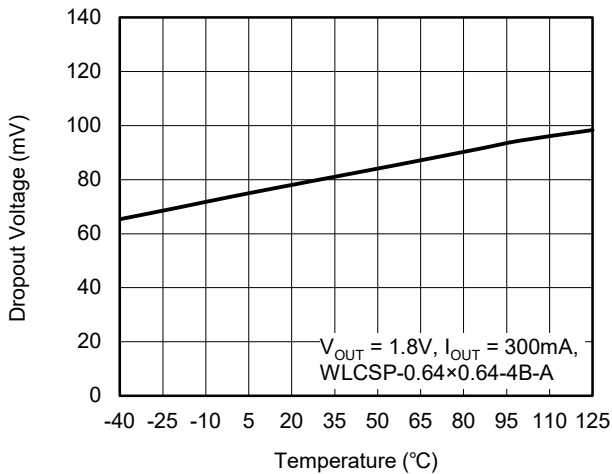

Dropout Voltage vs. Temperature

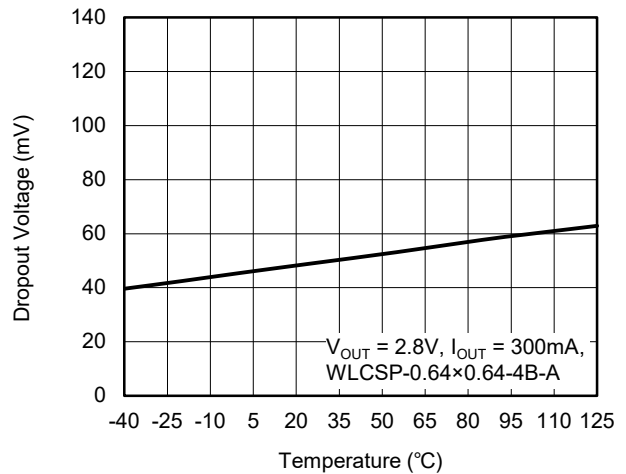

TYPICAL PERFORMANCE CHARACTERISTICS (continued)

$T_J = +25^\circ\text{C}$, $V_{IN} = (V_{OUT(NOM)} + 0.3\text{V})$ or 1.1V (whichever is greater), $V_{EN} = V_{IN}$, $C_{IN} = C_{OUT} = 1\mu\text{F}$, unless otherwise noted.

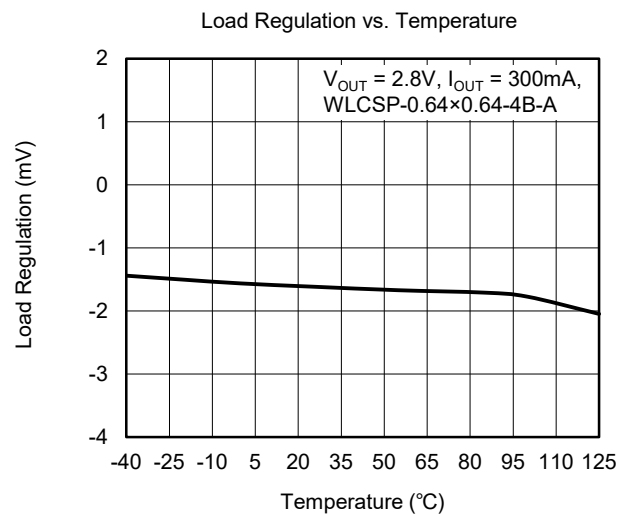
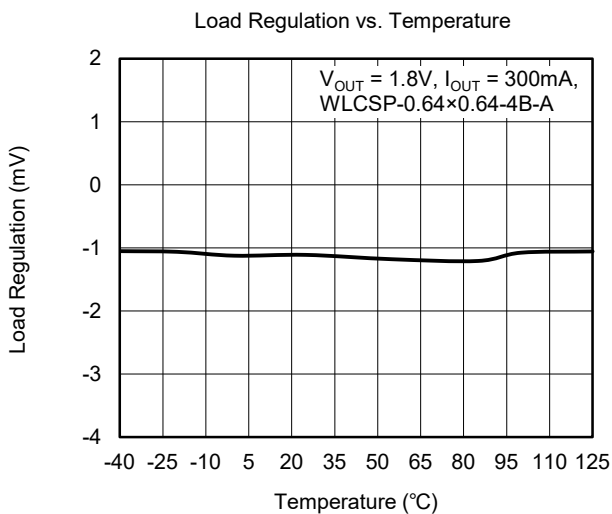
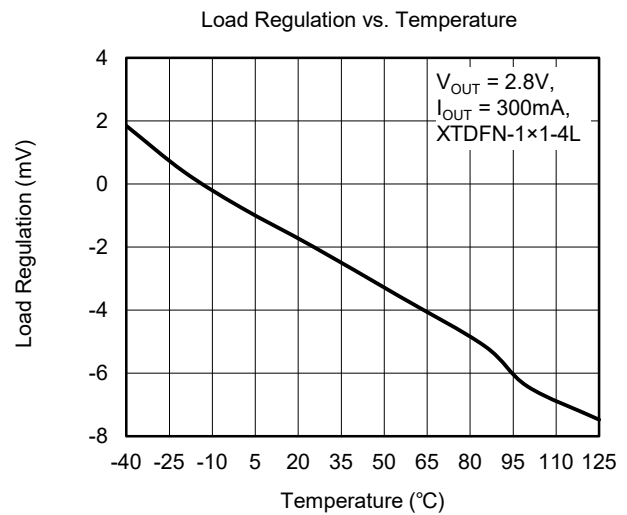
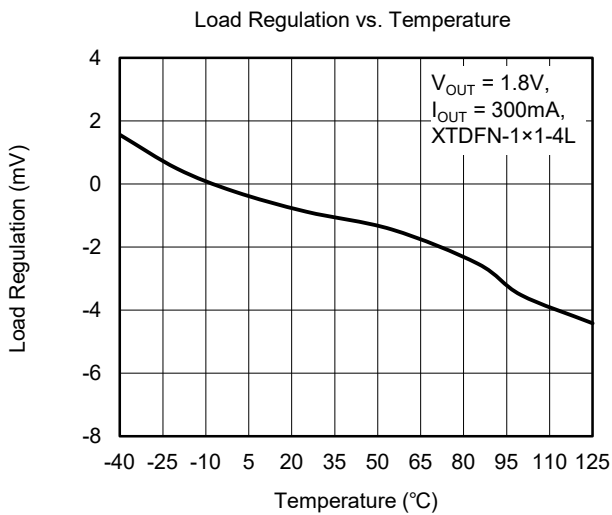
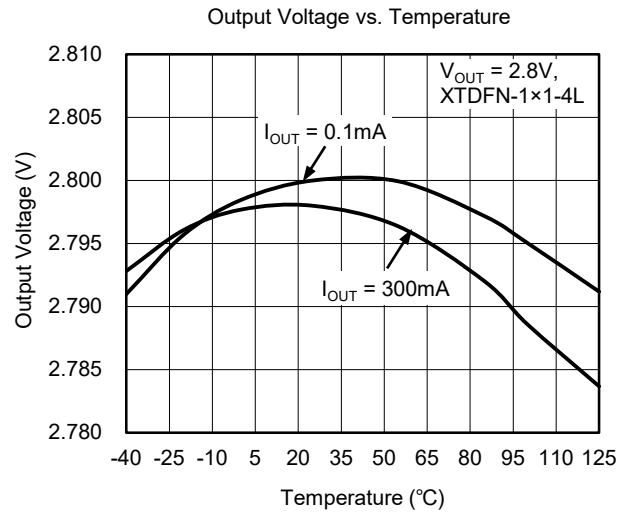
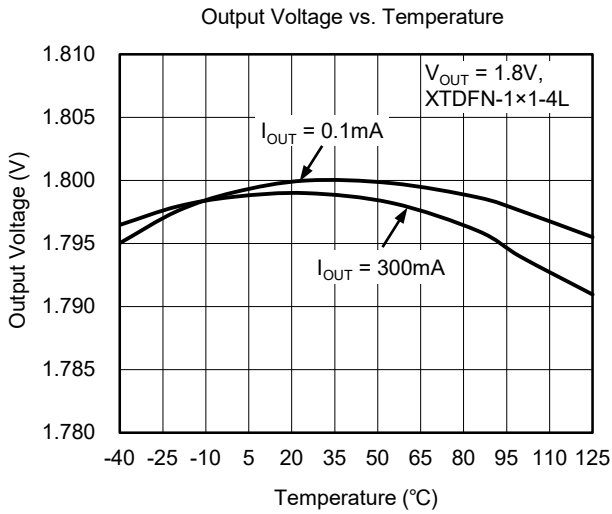

TYPICAL PERFORMANCE CHARACTERISTICS (continued)

$T_J = +25^\circ\text{C}$, $V_{IN} = (V_{OUT(NOM)} + 0.3\text{V})$ or 1.1V (whichever is greater), $V_{EN} = V_{IN}$, $C_{IN} = C_{OUT} = 1\mu\text{F}$, unless otherwise noted.

Enable Turn-On Response

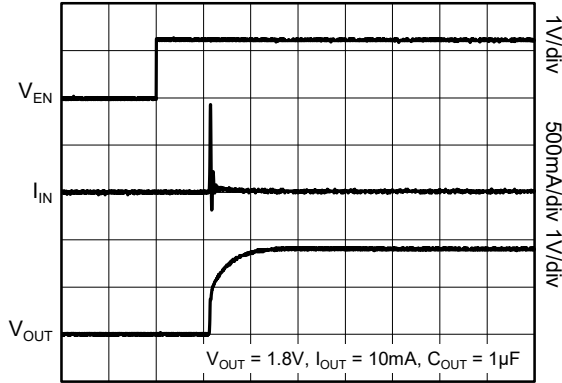

Time (50 $\mu\text{s}/\text{div}$)

Enable Turn-On Response

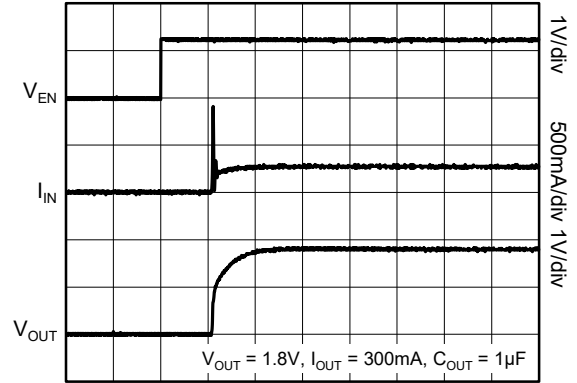

Time (50 $\mu\text{s}/\text{div}$)

Enable Turn-On Response

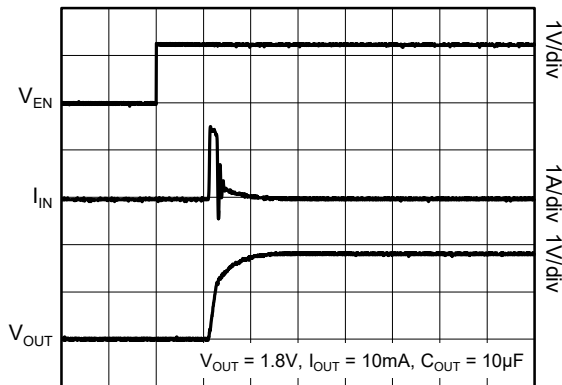

Time (50 $\mu\text{s}/\text{div}$)

Enable Turn-On Response

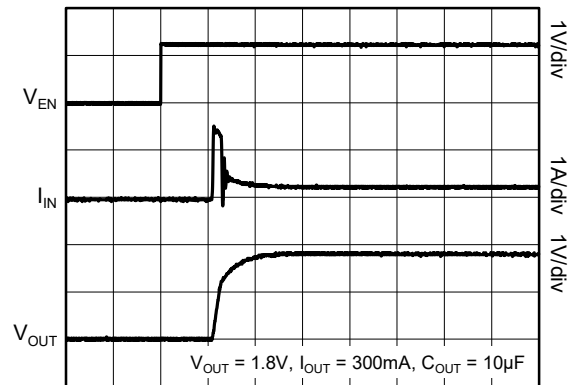

Time (50 $\mu\text{s}/\text{div}$)

Enable Turn-Off Response

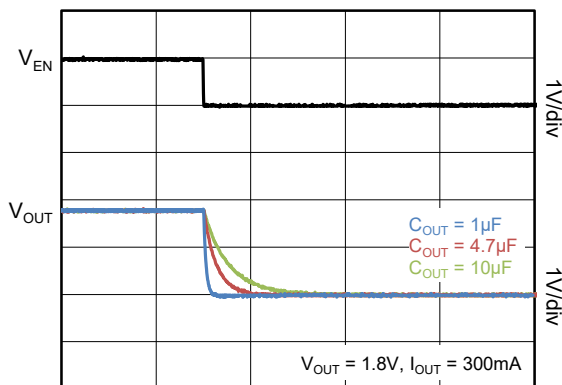

Time (200 $\mu\text{s}/\text{div}$)

FUNCTIONAL BLOCK DIAGRAM

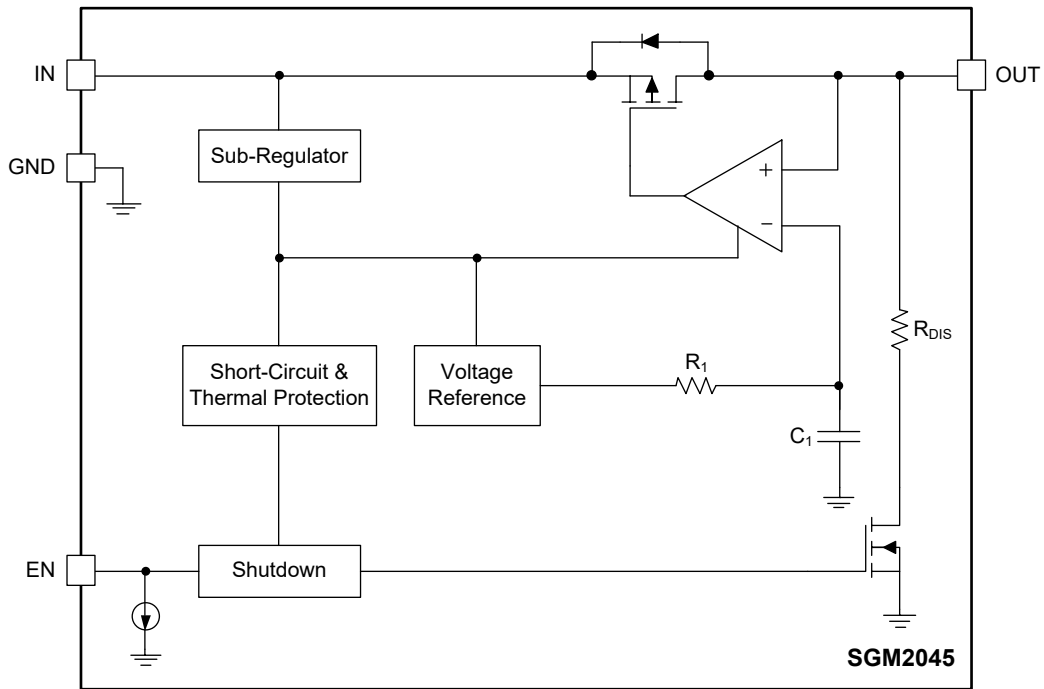

Figure 2. Block Diagram

APPLICATION INFORMATION

The SGM2045 is a low V_{IN} , ultra-low noise and low dropout LDO and provides 300mA output current. These features make the device a reliable solution to solve many challenging problems in the generation of clean and accurate power supply. The high performance also makes the SGM2045 useful in a variety of applications. The SGM2045 provides the protection functions for output overload, output short-circuit condition and overheating.

The SGM2045 provides an EN pin as an external chip enable control to enable/disable the device. When the regulator is in shutdown state, the shutdown current consumes as low as 0.03 μ A (TYP).

Input Capacitor Selection (C_{IN})

The input decoupling capacitor should be placed as close as possible to the IN pin to ensure the device stability. 1 μ F or larger X7R or X5R ceramic capacitor is selected to get good dynamic performance.

When V_{IN} is required to provide large current instantaneously, a large effective input capacitor is required. Multiple input capacitors can limit the input tracking inductance. Adding more input capacitors is available to restrict the ringing and to keep it below the device absolute maximum ratings.

Output Capacitor Selection (C_{OUT})

The output capacitor should be placed as close as possible to the OUT pin. 1 μ F or larger X7R or X5R ceramic capacitor is selected to get good dynamic performance. The minimum effective capacitance of C_{OUT} that SGM2045 can remain stable is 0.5 μ F. For ceramic capacitor, temperature, DC bias and package size will change the effective capacitance, so enough margin of C_{OUT} must be considered in design. Additionally, C_{OUT} with larger capacitance and lower ESR will help increase the high frequency PSRR and improve the load transient response.

Enable Operation

The EN pin of the SGM2045 is used to enable/disable its device and to deactivate/activate the output automatic discharge function.

When the EN pin voltage is lower than 0.3V, the device is in shutdown state. There is no current flowing from IN to OUT pins. In this state, the automatic discharge

transistor is active to discharge the output voltage through a 60 Ω (TYP) resistor.

When the EN pin voltage is higher than 0.7V, the device is in active state. The output voltage is regulated to the expected value and the automatic discharge transistor is turned off.

The EN pin is pulled down by internal 0.03 μ A (TYP) current source when the EN pin is floated. This current source will ensure the SGM2045 in shutdown state and reduce the power dissipation in system.

Reverse Current Protection

The PMOS power transistor has an inherent body diode. This body diode will be forward biased when $V_{OUT} > V_{IN}$. When $V_{OUT} > V_{IN}$, the reverse current flowing from the OUT pin to the IN pin will damage the SGM2045. If $V_{OUT} > V_{IN}$ event would happen in system, one external Schottky diode will be added between OUT pin and IN pin in circuit design to protect the SGM2045.

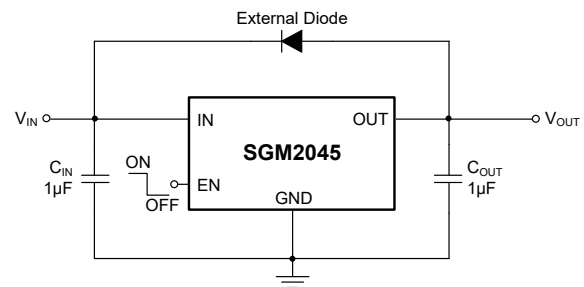

Figure 3. Reverse Protection Reference Design

Negatively Biased Output

When the output voltage is negative, the chip may not start up due to parasitic effects. Ensure that the output is greater than -0.3V under all conditions. If negatively biased output is excessive and expected in the application, a Schottky diode can be added between the OUT pin and GND pin.

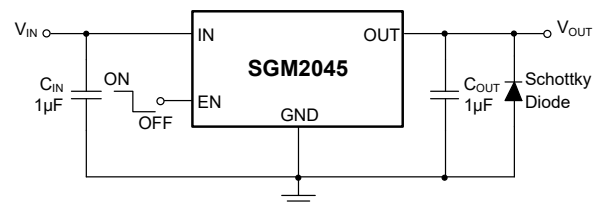

Figure 4. Negatively Biased Output Application

APPLICATION INFORMATION (continued)

Output Current Limit and Short-Circuit Protection

When overload events happen, the output current is internally limited to 600mA (TYP). When the OUT pin is shorted to ground, the short-circuit protection will limit the output current to 380mA (TYP).

Thermal Shutdown

The SGM2045 can detect the temperature of die. When the die temperature exceeds the threshold value of thermal shutdown, the SGM2045 will be in shutdown state and it will remain in this state until the die temperature decreases to +140°C.

Power Dissipation (P_D)

Power dissipation (P_D) of the SGM2045 can be calculated by the equation $P_D = (V_{IN} - V_{OUT}) \times I_{OUT}$. The maximum allowable power dissipation ($P_{D(MAX)}$) of the SGM2045 is affected by many factors, including the difference between junction temperature and ambient temperature ($T_{J(MAX)} - T_A$), package thermal resistance from the junction to the ambient environment (θ_{JA}), the rate of ambient airflow and PCB layout. $P_{D(MAX)}$ can be approximated by the following equation:

$$P_{D(MAX)} = (T_{J(MAX)} - T_A) / \theta_{JA} \quad (2)$$

REVISION HISTORY

NOTE: Page numbers for previous revisions may differ from page numbers in the current version.

JUNE 2023 – REV.B.1 to REV.B.2	Page
Added SGM2045-1.30XG/TR to Package/Ordering Information section	2
OCTOBER 2022 – REV.B to REV.B.1	Page
Added SGM2045-2.20XXDH4G/TR to Package/Ordering Information section	2
SEPTEMBER 2022 – REV.A.4 to REV.B	Page
Added SGM2045-1.825XXDH4G/TR to Package/Ordering Information section	2
AUGUST 2022 – REV.A.3 to REV.A.4	Page
Added SGM2045-2.90 to Package/Ordering Information section	2
AUGUST 2022 – REV.A.2 to REV.A.3	Page
Updated Recommended Operating Conditions section	3
Updated Electrical Characteristics section	5
DECEMBER 2021 – REV.A.1 to REV.A.2	Page
Updated Electrical Characteristics section	5
Updated Typical Performance Characteristics section	7, 9
OCTOBER 2021 – REV.A to REV.A.1	Page
Updated Electrical Characteristics section	5
Changes from Original (SEPTEMBER 2021) to REV.A	Page
Changed from product preview to production data	All

PACKAGE INFORMATION

PACKAGE OUTLINE DIMENSIONS

XTDFN-1x1-4L

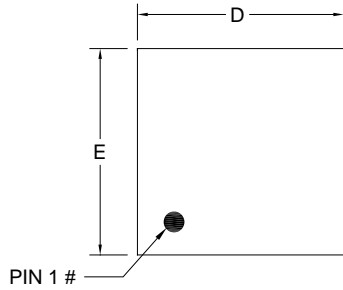

TOP VIEW

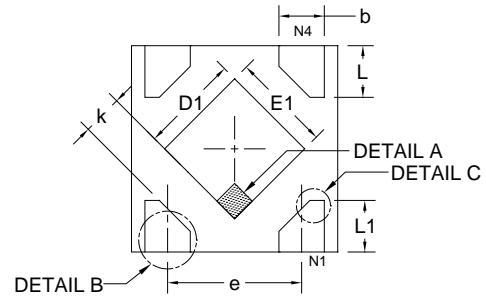

BOTTOM VIEW

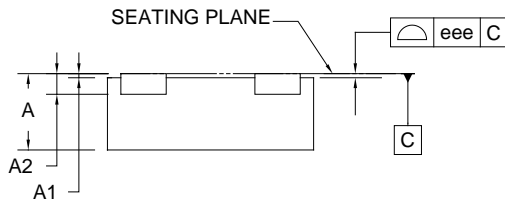

SIDE VIEW

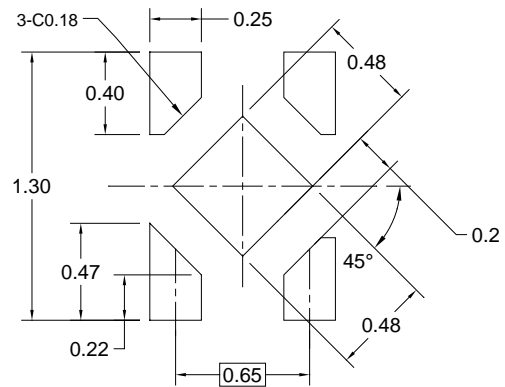

RECOMMENDED LAND PATTERN (Unit: mm)

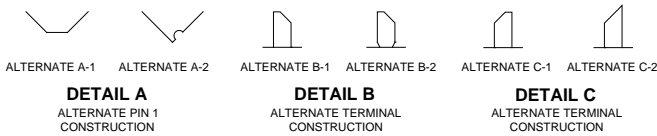

Symbol	Dimensions in Millimeters		
	MIN	MOD	MAX
A	0.340	0.370	0.400
A1	0.000	0.020	0.050
A2	0.100 REF		
b	0.170	-	0.300
D	0.950	1.000	1.050
E	0.950	1.000	1.050
D1	0.430	0.480	0.530
E1	0.430	0.480	0.530
L	0.200	0.250	0.300
L1	0.200	-	0.370
e	0.650 BSC		
k	0.150	-	-
eee	-	0.050	-

NOTE: This drawing is subject to change without notice.

PACKAGE OUTLINE DIMENSIONS

WLCSP-0.64x0.64-4B-A

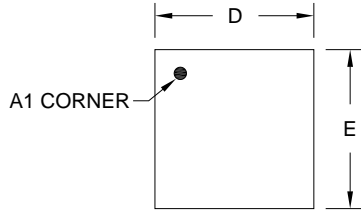

TOP VIEW

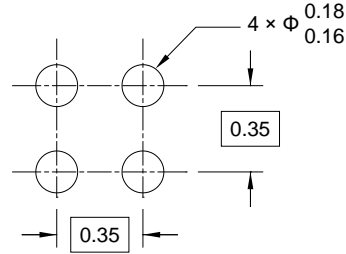

RECOMMENDED LAND PATTERN (Unit: mm)

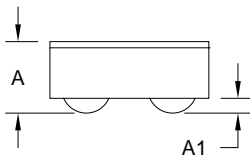

SIDE VIEW

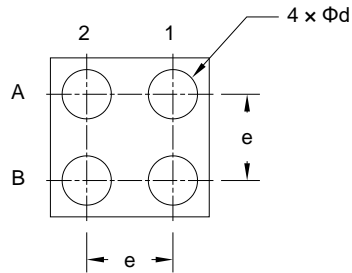

BOTTOM VIEW

Symbol	Dimensions In Millimeters		
	MIN	MOD	MAX
A	0.262	0.290	0.318
A1	0.050	0.060	0.070
D	0.620	0.645	0.670
E	0.620	0.645	0.670
d	0.190	0.200	0.210
e	0.350 BSC		

NOTE: This drawing is subject to change without notice.

TAPE AND REEL INFORMATION

REEL DIMENSIONS



TAPE DIMENSIONS



NOTE: The picture is only for reference. Please make the object as the standard.

KEY PARAMETER LIST OF TAPE AND REEL

Package Type	Reel Diameter	Reel Width W1 (mm)	A0 (mm)	B0 (mm)	K0 (mm)	P0 (mm)	P1 (mm)	P2 (mm)	W (mm)	Pin1 Quadrant
XTDFN-1×1-4L	7"	9.5	1.16	1.16	0.50	4.0	2.0	2.0	8.0	Q1
WLCSP-0.64×0.64-4B-A	7"	9.5	0.74	0.74	0.37	4.0	4.0	2.0	8.0	Q1

DD0001

PACKAGE INFORMATION

CARTON BOX DIMENSIONS

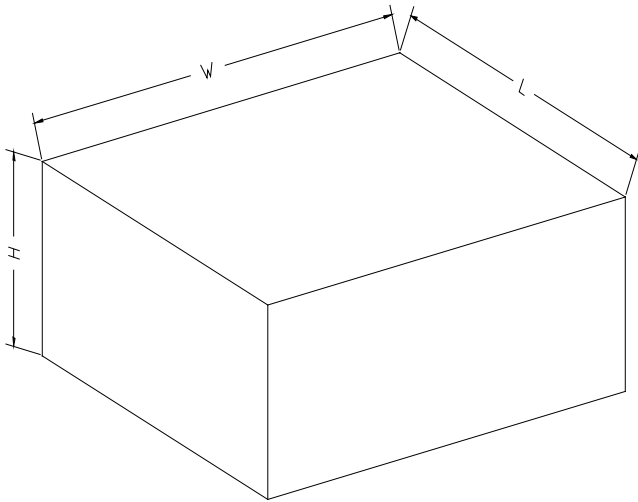

NOTE: The picture is only for reference. Please make the object as the standard.

KEY PARAMETER LIST OF CARTON BOX

Reel Type	Length (mm)	Width (mm)	Height (mm)	Pizza/Carton
7" (Option)	368	227	224	8
7"	442	410	224	18

DD0002

单击下面可查看定价，库存，交付和生命周期等信息

[>>SGMICRO\(圣邦微电子\)](#)