



# SGM8044

## 670nA, Quad Rail-to-Rail I/O Operational Amplifier

### GENERAL DESCRIPTION

The SGM8044 is a quad, high precision operational amplifier which can operate from 1.4V to 5.5V single supply, while consuming only 670nA/amplifier quiescent current. It provides rail-to-rail input and output operation. Therefore, the SGM8044 is suitable for use in portable instrumentation and battery-powered systems.

The SGM8044 is unity-gain stable, and features a 15kHz gain-bandwidth product. It is designed to provide optimal performance in low frequency systems, when monitoring battery current and conditioning sensor signal.

The SGM8044 is available in Green SOIC-14, TSSOP-14 and TQFN-3×3-16L packages. It is specified over the extended -40°C to +85°C temperature range.

### FEATURES

- **Low Quiescent Current: 670nA/Amplifier (TYP)**
- **Rail-to-Rail Input and Output**
- **Gain-Bandwidth Product: 15kHz at  $V_S = 5V$  (TYP)**
- **Wide Supply Voltage Range: 1.4V to 5.5V**
- **Unity-Gain Stable**
- **-40°C to +85°C Operating Temperature Range**
- **Available in Green SOIC-14, TSSOP-14 and TQFN-3×3-16L Packages**

### APPLICATIONS

Temperature Measurements  
Toll Booth Tags  
Battery-Powered Systems  
Wearable Products

**PACKAGE/ORDERING INFORMATION**

| MODEL   | PACKAGE DESCRIPTION | SPECIFIED TEMPERATURE RANGE | ORDERING NUMBER  | PACKAGE MARKING           | PACKING OPTION      |
|---------|---------------------|-----------------------------|------------------|---------------------------|---------------------|
| SGM8044 | SOIC-14             | -40°C to +85°C              | SGM8044YS14G/TR  | SGM8044YS14<br>XXXXX      | Tape and Reel, 2500 |
|         | TSSOP-14            | -40°C to +85°C              | SGM8044YTS14G/TR | SGM8044<br>YTS14<br>XXXXX | Tape and Reel, 3000 |
|         | TQFN-3x3-16L        | -40°C to +85°C              | SGM8044YTQ16G/TR | 8044TQ<br>XXXXX           | Tape and Reel, 4000 |

**MARKING INFORMATION**

NOTE: XXXXX = Date Code and Vendor Code.

**XXXXX**

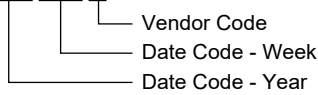

Green (RoHS & HSF): SG Micro Corp defines "Green" to mean Pb-Free (RoHS compatible) and free of halogen substances. If you have additional comments or questions, please contact your SGMICRO representative directly.

**ABSOLUTE MAXIMUM RATINGS**

|  |  |
|--|--|
| Supply Voltage.....                    | 6V   |
| Analog Inputs (+IN, -IN).....          | (-V <sub>S</sub> ) - 0.1V to (+V <sub>S</sub> ) + 0.1V |
| Differential Input Voltage.....        | (-V <sub>S</sub> ) - (+V <sub>S</sub> )                |
| Junction Temperature.....              | +150°C   |
| Storage Temperature Range.....         | -65°C to +150°C  |
| Lead Temperature (Soldering, 10s)..... | +260°C   |
| ESD Susceptibility                     |  |
| HBM.....                               | 4000V  |
| MM.....                                | 400V   |

**RECOMMENDED OPERATING CONDITIONS**

|                                  |                |
|----------------------------------|----------------|
| Supply Voltage Range.....        | 1.4V to 5.5V   |
| Operating Temperature Range..... | -40°C to +85°C |

**OVERSTRESS CAUTION**

Stresses beyond those listed in Absolute Maximum Ratings may cause permanent damage to the device. Exposure to absolute maximum rating conditions for extended periods may affect reliability. Functional operation of the device at any conditions beyond those indicated in the Recommended Operating Conditions section is not implied.

**ESD SENSITIVITY CAUTION**

This integrated circuit can be damaged if ESD protections are not considered carefully. SGMICRO recommends that all integrated circuits be handled with appropriate precautions. Failure to observe proper handling and installation procedures can cause damage. ESD damage can range from subtle performance degradation to complete device failure. Precision integrated circuits may be more susceptible to damage because even small parametric changes could cause the device not to meet the published specifications.

**DISCLAIMER**

SG Micro Corp reserves the right to make any change in circuit design, or specifications without prior notice.

PIN CONFIGURATIONS

(TOP VIEW)

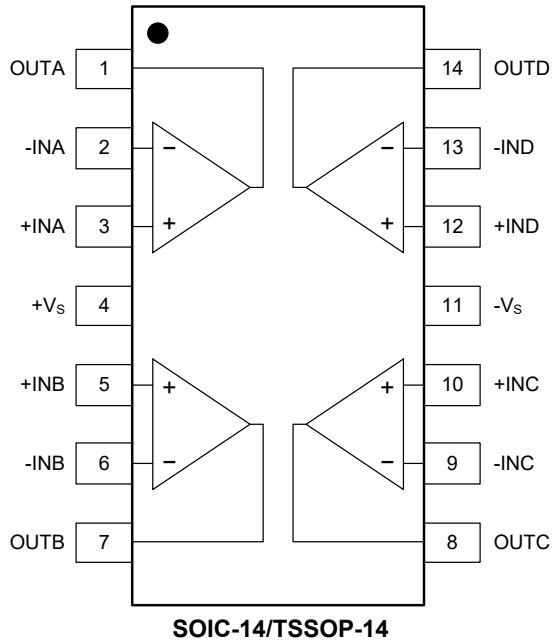

(TOP VIEW)

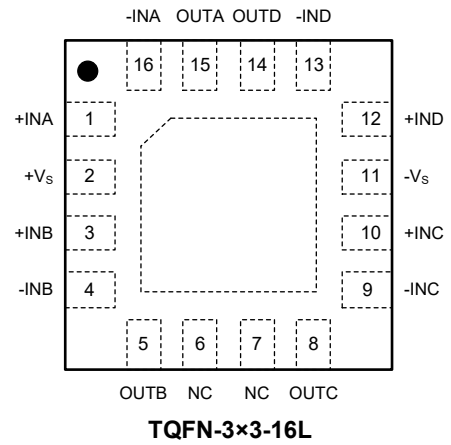

**ELECTRICAL CHARACTERISTICS**(At  $T_A = +25^\circ\text{C}$ ,  $+V_S = 1.4\text{V}$  to  $5\text{V}$ ,  $-V_S = \text{GND}$ ,  $V_{\text{CM}} = +V_S/2$ ,  $V_{\text{OUT}} \approx +V_S/2$  and  $R_L = 1\text{M}\Omega$  to  $+V_S/2$ , unless otherwise noted.)

| PARAMETER                            | SYMBOL                          | CONDITIONS  | MIN            | TYP   | MAX            | UNITS                        |    |
|--------------------------------------|---------------------------------|---|----------------|-------|----------------|------------------------------|----|
| <b>DC Electrical Characteristics</b> |                                 |   |                |       |                |                              |    |
| Input Offset Voltage                 | $V_{\text{OS}}$                 | $V_{\text{CM}} = +V_S/2$  |                | 0.7   | 2.5            | mV                           |    |
| Input Offset Voltage Drift           | $\Delta V_{\text{OS}}/\Delta T$ | $V_{\text{CM}} = +V_S/2$ , $-40^\circ\text{C} \leq T_A \leq +85^\circ\text{C}$            |                | 2.5   |                | $\mu\text{V}/^\circ\text{C}$ |    |
| Power Supply Rejection Ratio         | PSRR                            | $+V_S = 1.4\text{V}$ to $5.5\text{V}$   | 74             | 80    |                | dB                           |    |
| Input Common Mode Voltage Range      | $V_{\text{CMR}}$                |   | $(-V_S) - 0.1$ |       | $(+V_S) + 0.1$ | V                            |    |
| Common Mode Rejection Ratio          | CMRR                            | $+V_S = 5.0\text{V}$ , $V_{\text{CM}} = -0.1\text{V}$ to $5.1\text{V}$                    | 65             | 83    |                | dB                           |    |
|                                      |                                 | $+V_S = 5.0\text{V}$ , $V_{\text{CM}} = 2.5\text{V}$ to $5.1\text{V}$                     | 65             | 82    |                |                              |    |
|                                      |                                 | $+V_S = 5.0\text{V}$ , $V_{\text{CM}} = -0.1\text{V}$ to $2.5\text{V}$                    | 70             | 80    |                |                              |    |
| Large-Signal Voltage Gain            | $A_{\text{VO}}$                 | $+V_S = 1.4\text{V}$ , $R_L = 50\text{k}\Omega$ , $V_{\text{OUT}} = (+V_S) - 0.1\text{V}$ | 72             | 77    |                | dB                           |    |
|                                      |                                 | $+V_S = 2.5\text{V}$ , $R_L = 50\text{k}\Omega$ , $V_{\text{OUT}} = (+V_S) - 0.1\text{V}$ |                | 87    |                |                              |    |
|                                      |                                 | $+V_S = 5.0\text{V}$ , $R_L = 50\text{k}\Omega$ , $V_{\text{OUT}} = (+V_S) - 0.1\text{V}$ | 82             | 93    |                |                              |    |
| Input Bias Current                   | $I_{\text{B}}$                  |   |                | 1     |                | pA                           |    |
| Input Offset Current                 | $I_{\text{OS}}$                 |   |                | 1     |                | pA                           |    |
| Maximum Output Voltage Swing         | $V_{\text{OH}}$                 | $+V_S = 1.4\text{V}$ , $R_L = 50\text{k}\Omega$   | 1.390          | 1.394 |                | V                            |    |
|                                      |                                 | $+V_S = 2.5\text{V}$ , $R_L = 50\text{k}\Omega$   |                | 2.497 |                |                              |    |
|                                      |                                 | $+V_S = 5.0\text{V}$ , $R_L = 50\text{k}\Omega$   | 4.990          | 4.996 |                |                              |    |
|                                      | $V_{\text{OL}}$                 | $+V_S = 1.4\text{V}$ , $R_L = 50\text{k}\Omega$   |                |       | 5.4            | 10                           | mV |
|                                      |                                 | $+V_S = 2.5\text{V}$ , $R_L = 50\text{k}\Omega$   |                |       | 3.4            |                              |    |
|                                      |                                 | $+V_S = 5.0\text{V}$ , $R_L = 50\text{k}\Omega$   |                |       | 3.7            | 10                           |    |
| Output Short-Circuit Current         | $I_{\text{SC}}$                 | $+V_S = 2.5\text{V}$  |                | 5.2   |                | mA                           |    |
|                                      |                                 | $+V_S = 5.0\text{V}$  | 22             | 23    |                |                              |    |
| Supply Voltage                       | $V_{\text{CC}}$                 |   | 1.4            |       | 5.5            | V                            |    |
| Quiescent Current/Amplifier          | $I_{\text{Q}}$                  | $+V_S = 1.4\text{V}$  |                | 550   |                | nA                           |    |
|                                      |                                 | $+V_S = 2.5\text{V}$  |                | 610   |                |                              |    |
|                                      |                                 | $+V_S = 5.0\text{V}$  |                | 670   | 1500           |                              |    |

**ELECTRICAL CHARACTERISTICS (continued)**

(At  $T_A = +25^\circ\text{C}$ ,  $+V_S = 1.4\text{V}$  to  $5\text{V}$ ,  $-V_S = \text{GND}$ ,  $V_{CM} = +V_S/2$ ,  $V_{OUT} \approx +V_S/2$  and  $R_L = 1\text{M}\Omega$  to  $+V_S/2$ ,  $C_L = 60\text{pF}$ , unless otherwise noted.)

| PARAMETER                            | SYMBOL      | CONDITIONS   | MIN | TYP  | MAX | UNITS                        |
|--------------------------------------|-------------|--|-----|------|-----|------------------------------|
| <b>AC Electrical Characteristics</b> |             |  |     |      |     |                              |
| Gain-Bandwidth Product               | GBP         | $+V_S = 1.4\text{V}$                                       |     | 13.5 |     | kHz                          |
|                                      |             | $+V_S = 2.5\text{V}$                                       |     | 14.5 |     |                              |
|                                      |             | $+V_S = 5.0\text{V}$                                       |     | 15   |     |                              |
| Slew Rate                            | SR          | $+V_S = 1.4\text{V}$ , $V_{OUT} = 1\text{V}$ Step          |     | 3.0  |     | V/ms                         |
|                                      |             | $+V_S = 2.5\text{V}$ , $V_{OUT} = 1\text{V}$ Step          |     | 3.1  |     |                              |
|                                      |             | $+V_S = 5.0\text{V}$ , $V_{OUT} = 2\text{V}$ Step          |     | 3.4  |     |                              |
| Phase Margin                         | PM          | $+V_S = 1.4\text{V}$ to $5.5\text{V}$                      |     | 60   |     | $^\circ$                     |
| Input Voltage Noise                  | $e_{n,P-P}$ | $+V_S = 1.4\text{V}$ , $f = 0.1\text{Hz}$ to $10\text{Hz}$ |     | 3.5  |     | $\mu\text{V}_{P-P}$          |
|                                      |             | $+V_S = 2.5\text{V}$ , $f = 0.1\text{Hz}$ to $10\text{Hz}$ |     | 3.4  |     |                              |
|                                      |             | $+V_S = 5.0\text{V}$ , $f = 0.1\text{Hz}$ to $10\text{Hz}$ |     | 3.2  |     |                              |
| Input Voltage Noise Density          | $e_n$       | $+V_S = 1.4\text{V}$ , $f = 1\text{kHz}$                   |     | 205  |     | $\text{nV}/\sqrt{\text{Hz}}$ |
|                                      |             | $+V_S = 2.5\text{V}$ , $f = 1\text{kHz}$                   |     | 185  |     |                              |
|                                      |             | $+V_S = 5.0\text{V}$ , $f = 1\text{kHz}$                   |     | 190  |     |                              |

**TYPICAL PERFORMANCE CHARACTERISTICS**

At  $T_A = +25^\circ\text{C}$ ,  $+V_S = 1.4\text{V to } 5\text{V}$ ,  $-V_S = \text{GND}$ ,  $V_{CM} = +V_S/2$ ,  $V_{OUT} \approx +V_S/2$  and  $R_L = 1\text{M}\Omega$  to  $+V_S/2$ ,  $C_L = 60\text{pF}$ , unless otherwise noted.

Large-Signal Inverting Pulse Response

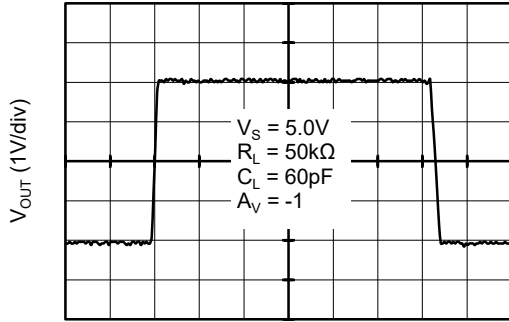

Time (5ms/div)

Large-Signal Non-Inverting Pulse Response

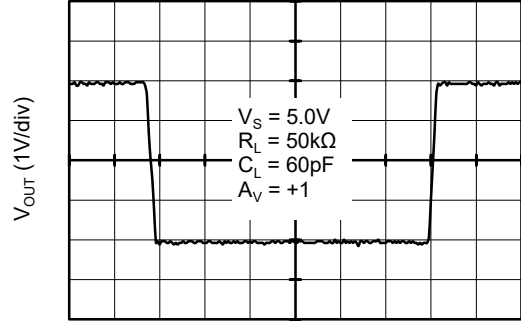

Time (5ms/div)

Small-Signal Inverting Pulse Response

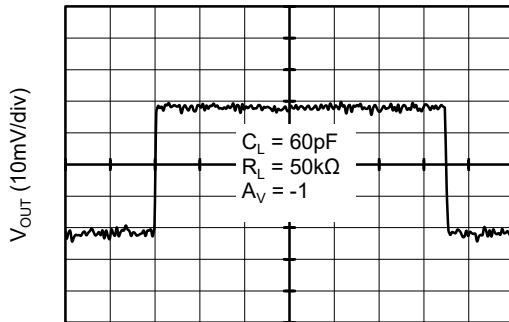

Time (5ms/div)

Small-Signal Non-Inverting Pulse Response

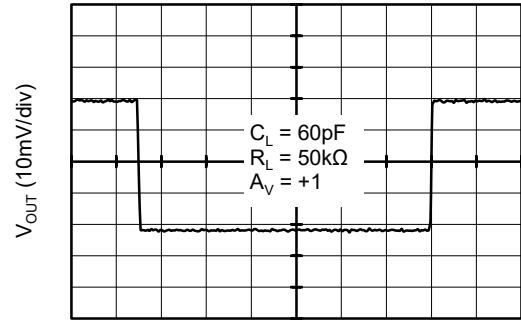

Time (5ms/div)

No Phase Reversal

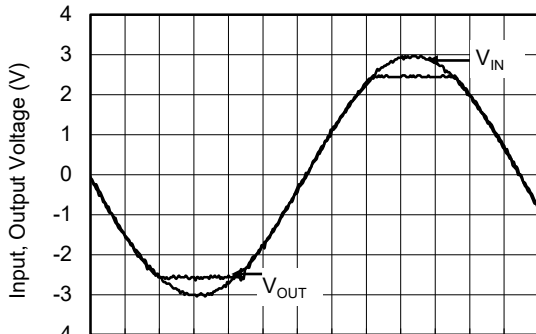

Time (5ms/div)

Slew Rate vs. Temperature

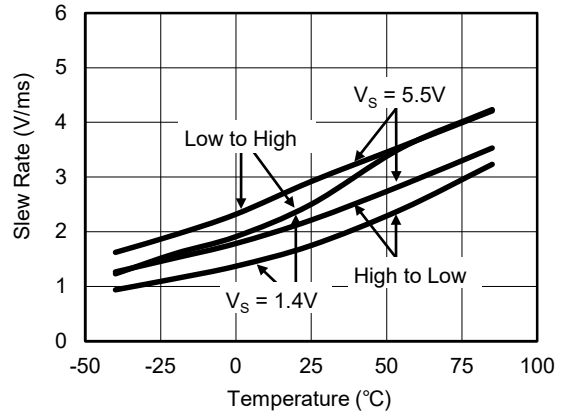

**TYPICAL PERFORMANCE CHARACTERISTICS (continued)**

At  $T_A = +25^\circ\text{C}$ ,  $+V_S = 1.4\text{V to } 5\text{V}$ ,  $-V_S = \text{GND}$ ,  $V_{CM} = +V_S/2$ ,  $V_{OUT} \approx +V_S/2$  and  $R_L = 1\text{M}\Omega$  to  $+V_S/2$ ,  $C_L = 60\text{pF}$ , unless otherwise noted.

Gain-Bandwidth Product and Phase Margin vs. Input Common Mode Voltage

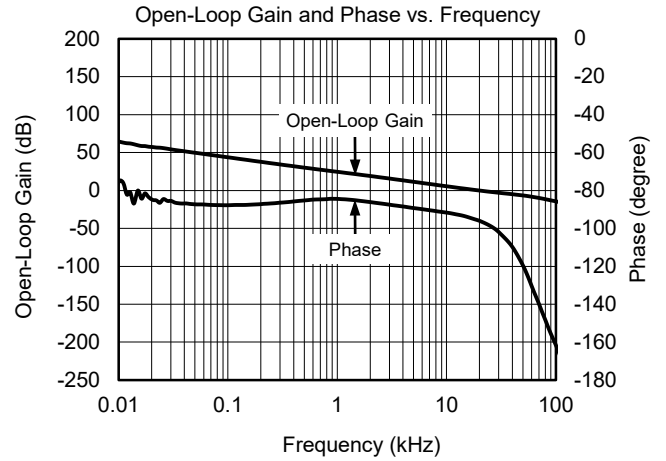
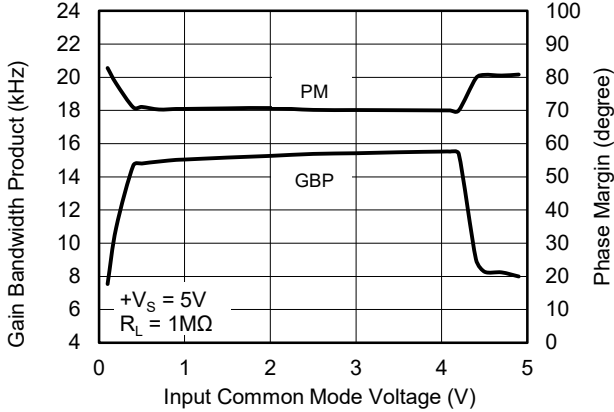

Offset Voltage Production Distribution at +5V

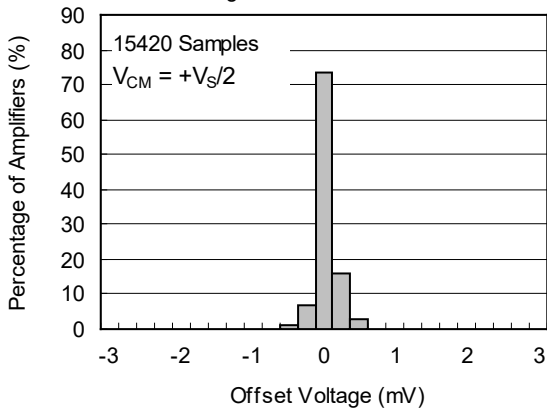

Offset Voltage Production Distribution at +1.4V

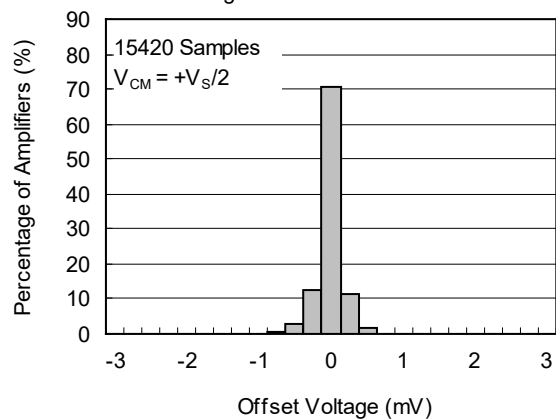

**REVISION HISTORY**

NOTE: Page numbers for previous revisions may differ from page numbers in the current version.

| <b>OCTOBER 2017 – REV.A.3 to REV.A.4</b>                  | <b>Page</b> |
|---|-------------|
| Updated Typical Performance Characteristics section ..... | 6           |
| <b>SEPTEMBER 2015 – REV.A.2 to REV.A.3</b>                | <b>Page</b> |
| Added TQFN-3×3-16L Package .....                          | All         |
| Updated Package Outline Dimensions section .....          | 7~8         |
| <b>JANUARY 2013 – REV.A.1 to REV.A.2</b>                  | <b>Page</b> |
| Added Tape and Reel Information section .....             | 9~10        |
| <b>MAY 2011 – REV.A to REV.A.1</b>                        | <b>Page</b> |
| Updated Package Description .....                         | All         |
| <b>Changes from Original (JUNE 2010) to REV.A</b>         | <b>Page</b> |
| Changed from product preview to production data .....     | All         |



# PACKAGE INFORMATION

## PACKAGE OUTLINE DIMENSIONS

### SOIC-14

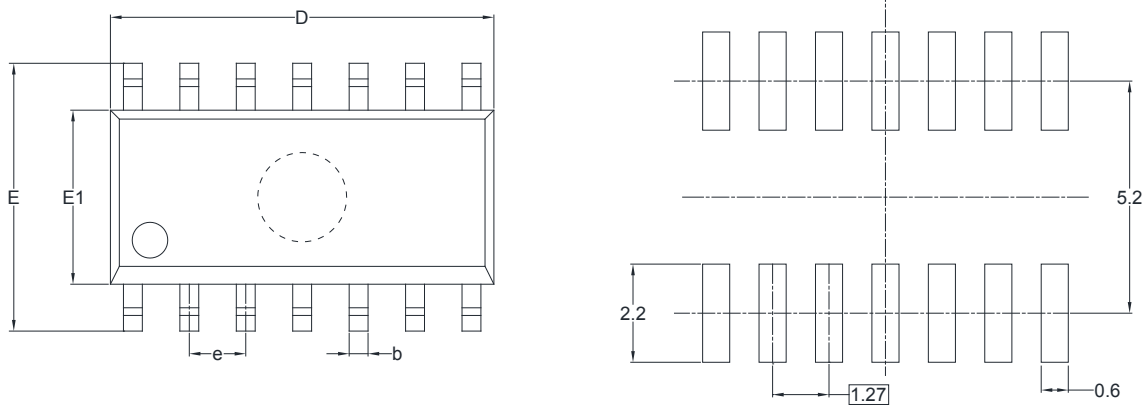

RECOMMENDED LAND PATTERN (Unit: mm)

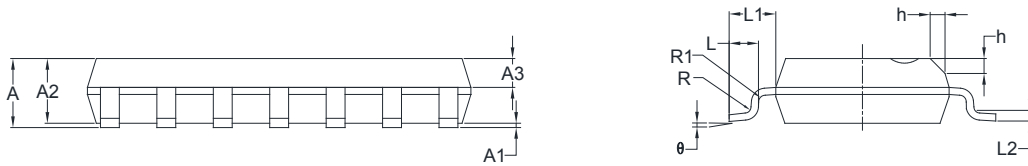

| Symbol | Dimensions<br>In Millimeters |      | Dimensions<br>In Inches |       |
|--------|------------------------------|------|-------------------------|-------|
|        | MIN                          | MAX  | MIN                     | MAX   |
| A      | 1.35                         | 1.75 | 0.053                   | 0.069 |
| A1     | 0.10                         | 0.25 | 0.004                   | 0.010 |
| A2     | 1.25                         | 1.65 | 0.049                   | 0.065 |
| A3     | 0.55                         | 0.75 | 0.022                   | 0.030 |
| b      | 0.36                         | 0.49 | 0.014                   | 0.019 |
| D      | 8.53                         | 8.73 | 0.336                   | 0.344 |
| E      | 5.80                         | 6.20 | 0.228                   | 0.244 |
| E1     | 3.80                         | 4.00 | 0.150                   | 0.157 |
| e      | 1.27 BSC                     |      | 0.050 BSC               |       |
| L      | 0.45                         | 0.80 | 0.018                   | 0.032 |
| L1     | 1.04 REF                     |      | 0.040 REF               |       |
| L2     | 0.25 BSC                     |      | 0.01 BSC                |       |
| R      | 0.07                         |      | 0.003                   |       |
| R1     | 0.07                         |      | 0.003                   |       |
| h      | 0.30                         | 0.50 | 0.012                   | 0.020 |
| θ      | 0°                           | 8°   | 0°                      | 8°    |

PACKAGE OUTLINE DIMENSIONS

TSSOP-14

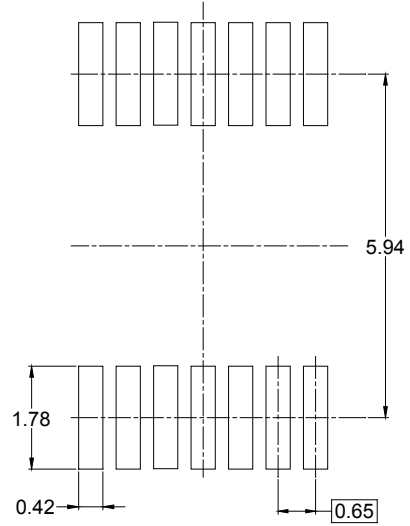
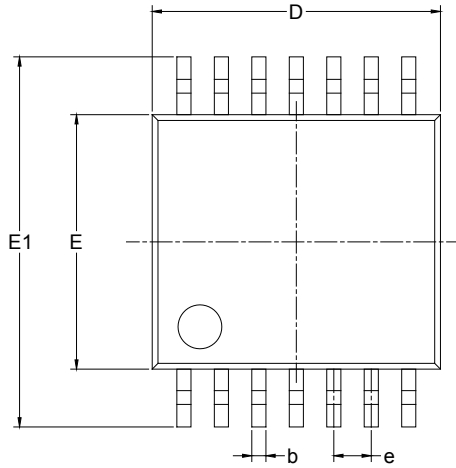

RECOMMENDED LAND PATTERN (Unit: mm)

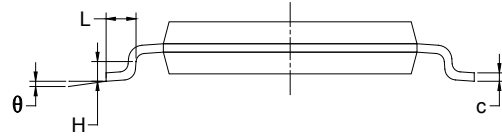
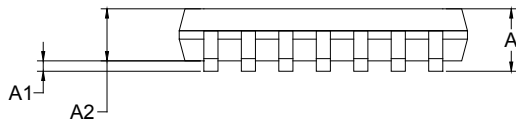

| Symbol | Dimensions<br>In Millimeters |       | Dimensions<br>In Inches |       |
|--------|------------------------------|-------|-------------------------|-------|
|        | MIN                          | MAX   | MIN                     | MAX   |
| A      |                              | 1.200 |                         | 0.047 |
| A1     | 0.050                        | 0.150 | 0.002                   | 0.006 |
| A2     | 0.800                        | 1.050 | 0.031                   | 0.041 |
| b      | 0.190                        | 0.300 | 0.007                   | 0.012 |
| c      | 0.090                        | 0.200 | 0.004                   | 0.008 |
| D      | 4.860                        | 5.100 | 0.191                   | 0.201 |
| E      | 4.300                        | 4.500 | 0.169                   | 0.177 |
| E1     | 6.250                        | 6.550 | 0.246                   | 0.258 |
| e      | 0.650 BSC                    |       | 0.026 BSC               |       |
| L      | 0.500                        | 0.700 | 0.02                    | 0.028 |
| H      | 0.25 TYP                     |       | 0.01 TYP                |       |
| θ      | 1°                           | 7°    | 1°                      | 7°    |

# PACKAGE INFORMATION

## PACKAGE OUTLINE DIMENSIONS

### TQFN-3×3-16L

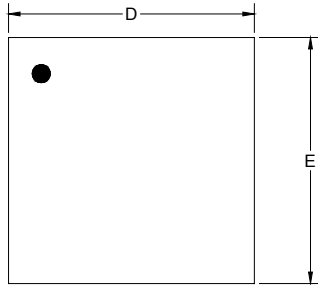

TOP VIEW

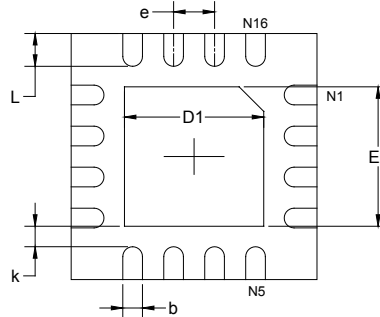

BOTTOM VIEW

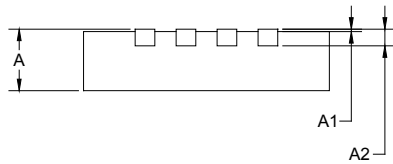

SIDE VIEW

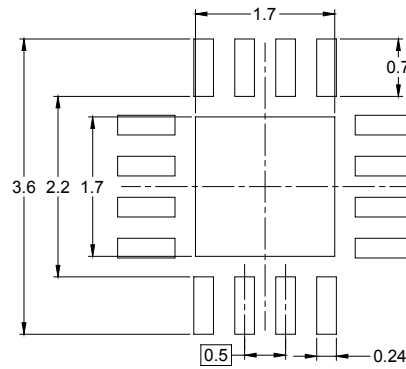

RECOMMENDED LAND PATTERN (Unit: mm)

| Symbol | Dimensions<br>In Millimeters |       | Dimensions<br>In Inches |       |
|--------|------------------------------|-------|-------------------------|-------|
|        | MIN                          | MAX   | MIN                     | MAX   |
| A      | 0.700                        | 0.800 | 0.028                   | 0.031 |
| A1     | 0.000                        | 0.050 | 0.000                   | 0.002 |
| A2     | 0.203 REF                    |       | 0.008 REF               |       |
| D      | 2.900                        | 3.100 | 0.114                   | 0.122 |
| D1     | 1.600                        | 1.800 | 0.063                   | 0.071 |
| E      | 2.900                        | 3.100 | 0.114                   | 0.122 |
| E1     | 1.600                        | 1.800 | 0.063                   | 0.071 |
| k      | 0.200 MIN                    |       | 0.008 MIN               |       |
| b      | 0.180                        | 0.300 | 0.007                   | 0.012 |
| e      | 0.500 TYP                    |       | 0.020 TYP               |       |
| L      | 0.300                        | 0.500 | 0.012                   | 0.020 |

# PACKAGE INFORMATION

## TAPE AND REEL INFORMATION

### REEL DIMENSIONS



### TAPE DIMENSIONS



NOTE: The picture is only for reference. Please make the object as the standard.

### KEY PARAMETER LIST OF TAPE AND REEL

| Package Type | Reel Diameter | Reel Width W1 (mm) | A0 (mm) | B0 (mm) | K0 (mm) | P0 (mm) | P1 (mm) | P2 (mm) | W (mm) | Pin1 Quadrant |
|--------------|---------------|--------------------|---------|---------|---------|---------|---------|---------|--------|---------------|
| SOIC-14      | 13"           | 16.4               | 6.60    | 9.30    | 2.10    | 4.0     | 8.0     | 2.0     | 16.0   | Q1            |
| TSSOP-14     | 13"           | 12.4               | 6.95    | 5.60    | 1.20    | 4.0     | 8.0     | 2.0     | 12.0   | Q1            |
| TQFN-3×3-16L | 13"           | 12.4               | 3.35    | 3.35    | 1.13    | 4.0     | 8.0     | 2.0     | 12.0   | Q1            |

DD0001

# PACKAGE INFORMATION

## CARTON BOX DIMENSIONS



NOTE: The picture is only for reference. Please make the object as the standard.

## KEY PARAMETER LIST OF CARTON BOX

| Reel Type | Length (mm) | Width (mm) | Height (mm) | Pizza/Carton |
|-----------|-------------|------------|-------------|--------------|
| 13"       | 386         | 280        | 370         | 5            |

DD0002

单击下面可查看定价，库存，交付和生命周期等信息

[>>SGMICRO\(圣邦微电子\)](#)