



SGM4916

88mW, Capless, Stereo Headphone Amplifier with Shutdown

GENERAL DESCRIPTION

The SGM4916 is stereo headphone amplifier which is designed for portable applications and can operate from a 2.7V to 5.5V single supply. Capless design can produce a ground-referenced output from a single power supply, and can eliminate output DC-blocking capacitors for less-component height and low-cost. For SGM4916B, the internal gain setting (-1.5V/V) is to further reduce component count. For SGM4916A, the gain can be adjusted by external feedback resistors.

The SGM4916 has low quiescent current 2.7mA at 5V supply, low 0.034% THD+N, 88mW per channel into 32Ω load from 5V power supply at THD+N = 0.1%. The high supply rejection ratio (PSRR) of -70dB at 217Hz allows the device to operate from noisy digital supplies without an additional linear regulator. The device provides short-circuit and thermal-overload protections. Build-in shutdown control also helps for pop/click-free on/off control.

The SGM4916 is available in a Green TQFN-3×3-12L package. It operates over an ambient temperature range of -40°C to +85°C.

FEATURES

- **Supply Voltage Range: 2.7V to 5.5V**
- **SGM4916A: External Feedback Gain Network**
SGM4916B: Fixed -1.5V/V Gain
- **Capless Structure**
 - ♦ **Eliminates Ground-Referenced Outputs**
 - ♦ **Eliminates Output DC-Blocking Capacitors**
 - ♦ **Provides Flat Frequency Response**
- **88mW into 32Ω Load from 5V Power Supply at THD+N = 0.1% (Typical, per Channel)**
- **THD+N = 0.034% (f = 1kHz)**
- **High PSRR: -70dB (at 217Hz)**
- **Quiescent Current: 2.7mA (TYP)**
- **Shutdown Control**
- **Short-Circuit and Thermal-Overload Protections**
- **Under-Voltage Lockout Function**
- **-40°C to +85°C Operating Temperature Range**
- **Available in a Green TQFN-3×3-12L Package**

APPLICATIONS

Smart Phones
Portable Audio Equipment
Notebook PCs
PDAs

PACKAGE/ORDERING INFORMATION

| MODEL | GAIN (V/V) | PACKAGE DESCRIPTION | SPECIFIED TEMPERATURE RANGE | ORDERING NUMBER | PACKAGE MARKING | PACKING OPTION |
|----------|------------|---------------------|-----------------------------|--------------------|-----------------|---------------------|
| SGM4916A | ADJ | TQFN-3×3-12L | -40°C to +85°C | SGM4916AYTQJ12G/TR | 4916AQ XXXXX | Tape and Reel, 3000 |
| SGM4916B | -1.5 | TQFN-3×3-12L | -40°C to +85°C | SGM4916BYTQJ12G/TR | 4916BQ XXXXX | Tape and Reel, 3000 |

MARKING INFORMATION

NOTE: XXXXX = Date Code and Vendor Code.

XXXXX

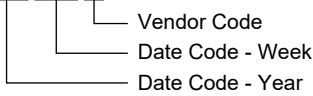

Green (RoHS & HSF): SG Micro Corp defines "Green" to mean Pb-Free (RoHS compatible) and free of halogen substances. If you have additional comments or questions, please contact your SGMICRO representative directly.

ABSOLUTE MAXIMUM RATINGS

- PV_{SS} to SV_{SS}..... -0.3V to +0.3V
- PGND to SGND..... -0.3V to +0.3V
- PV_{SS} and SV_{SS} to PGND or SGND..... -6V to +0.3V
- IN to SGND..... (SV_{SS} - 0.3V) to (SV_{DD} + 0.3V)
- SHDN to SGND..... -0.3V to (SV_{DD} + 0.3V)
- OUT to SGND..... (SV_{SS} - 0.3V) to (SV_{DD} + 0.3V)
- C1P to PGND..... -0.3V to (PV_{DD} + 0.3V)
- C1N to PGND..... (PV_{SS} - 0.3V) to + 0.3V
- Output Short Circuit to GND or V_{DD}..... Continuous
- Junction Temperature..... +150°C
- Storage Temperature Range..... -65°C to +150°C
- Lead Temperature (Soldering, 10s)..... +260°C
- ESD Susceptibility
- HBM (Output pins to Supply and Ground pins)..... 3000V
- MM..... 200V

RECOMMENDED OPERATING CONDITIONS

- Supply Voltage Range..... 2.7V to 5.5V
- Operating Temperature Range..... -40°C to +85°C

OVERSTRESS CAUTION

Stresses beyond those listed in Absolute Maximum Ratings may cause permanent damage to the device. Exposure to absolute maximum rating conditions for extended periods may affect reliability. Functional operation of the device at any conditions beyond those indicated in the Recommended Operating Conditions section is not implied.

ESD SENSITIVITY CAUTION

This integrated circuit can be damaged if ESD protections are not considered carefully. SGMICRO recommends that all integrated circuits be handled with appropriate precautions. Failure to observe proper handling and installation procedures can cause damage. ESD damage can range from subtle performance degradation to complete device failure. Precision integrated circuits may be more susceptible to damage because even small parametric changes could cause the device not to meet the published specifications.

DISCLAIMER

SG Micro Corp reserves the right to make any change in circuit design, or specifications without prior notice.

PIN CONFIGURATION

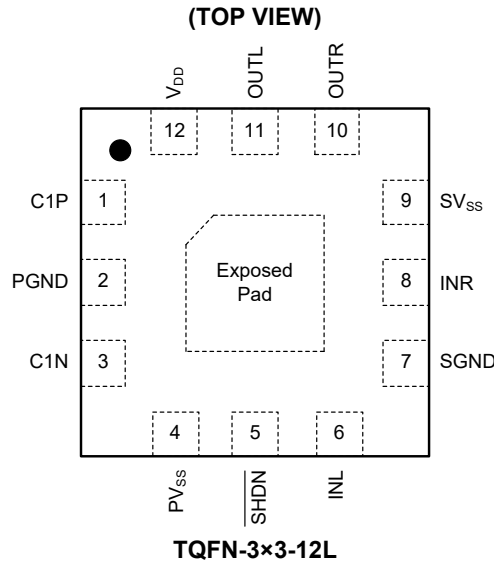

PIN DESCRIPTIONS

| PIN | NAME | DESCRIPTION |
|-------------|------------------|--|
| 1 | C1P | Positive Terminal for Flying Capacitor. Connect a 1μF capacitor to C1N. |
| 2 | PGND | Power Ground. Connect to SGND. |
| 3 | C1N | Negative Terminal for Flying Capacitor. Connect a 1μF capacitor to C1P. |
| 4 | PV _{SS} | Charge-Pump Output. Connect to SV _{SS} and bypass with a 1μF ceramic capacitor to PGND. |
| 5 | SHDN | Active-Low Shutdown Input. |
| 6 | INL | Input for Left-Channel. |
| 7 | SGND | Signal Ground. Connect to PGND. |
| 8 | INR | Input for Right-Channel. |
| 9 | SV _{SS} | Amplifier Negative Supply. Connect to PV _{SS} . |
| 10 | OUTR | Output for Right-Channel. |
| 11 | OUTL | Output for Left-Channel. |
| 12 | V _{DD} | Positive Power-Supply Input. Bypass with a 1μF capacitor to SGND. |
| Exposed Pad | — | Exposed Pad. Can be connected to GND or left floating. |

ELECTRICAL CHARACTERISTICS

($V_{DD} = 5V$, $PGND = SGND = 0V$, $\overline{SHDN} = 5V$, $C1 = C2 = 1\mu F$, $R_L = \infty$; for SGM4916A, gain = $-1.5V/V$ ($R_{IN} = 20k\Omega$, $R_F = 30k\Omega$); for SGM4916B, gain = $-1.5V/V$ (internally set). $T_A = +25^\circ C$, unless otherwise noted.)⁽¹⁾

| PARAMETER | SYMBOL | CONDITIONS | MIN | TYP | MAX | UNITS |
|--|--------------|---|---|--------------|-------|------------|
| General | | | | | | |
| Supply Voltage Range | V_{DD} | | 2.7 | | 5.5 | V |
| Quiescent Supply Current | I_{DD} | | | 2.7 | 3.7 | mA |
| Shutdown Supply Current | I_{SHDN} | $\overline{SHDN} = SGND = PGND$ | | 0.01 | 8 | μA |
| \overline{SHDN} Input Logic High | V_{IH} | | 1.2 | | | V |
| \overline{SHDN} Input Logic Low | V_{IL} | | | | 0.4 | V |
| \overline{SHDN} to Full Operation Time | t_{SON} | | | 3.1 | | ms |
| Amplifiers | | | | | | |
| Voltage Gain | A_V | SGM4916B | -1.57 | -1.5 | -1.43 | V/V |
| Gain Matching | ΔA_V | SGM4916B | | 0.23 | | % |
| Output Offset Voltage | V_{OS} | Input AC-coupled to ground | -6 | 1.2 | 6 | mV |
| Input Impedance | R_{IN} | SGM4916B, measured at INL and INR | 12.5 | 14.3 | 16.5 | k Ω |
| Power Supply Rejection Ratio | PSRR | SGM4916B, $C3 = 0.1\mu F$ | $f = 217Hz$, $V_{RIPPLE} = 200mV_{P-P}$ | | -70 | dB |
| | | | $f = 1kHz$, $V_{RIPPLE} = 200mV_{P-P}$ | | -71 | |
| | | | $f = 20kHz$, $V_{RIPPLE} = 200mV_{P-P}$ | | -70 | |
| Output Power | P_{OUT} | $R_L = 32\Omega$, $f = 1kHz$ | $V_{DD} = 5.0V$ | THD+N = 0.1% | 88 | mW |
| | | | | THD+N = 1% | 98 | |
| | | | $V_{DD} = 3.0V$ | THD+N = 0.1% | 33 | |
| | | | | THD+N = 1% | 36 | |
| | | | $V_{DD} = 2.7V$ | THD+N = 0.1% | 26 | |
| | | | | THD+N = 1% | 29 | |
| Total Harmonic Distortion Plus Noise | THD+N | $R_L = 32\Omega$, $P_{OUT} = 30mW$, $f_{IN} = 1kHz$ | | 0.034 | % | |
| | | | $R_L = 32\Omega$, $P_{OUT} = 50mW$, $f_{IN} = 1kHz$ | 0.025 | | |
| Signal-to-Noise Ratio | SNR | $R_L = 32\Omega$, $P_{OUT} = 50mW$, $BW = 20Hz$ to $22kHz$ | | 103 | | dB |
| Capacitive Drive | C_L | No sustained oscillations | | 200 | | pF |
| Charge-Pump Oscillator Frequency | f_{OSC} | | 215 | 340 | 495 | kHz |
| Crosstalk | | $V_{DD} = 3.0V$, L to R, R to L, $f = 10kHz$, $R_L = 32\Omega$, $P_{OUT} = 15mW$ | | 63 | | dB |
| Thermal Shutdown Threshold | | | | 142 | | $^\circ C$ |
| Thermal Shutdown Hysteresis | | | | 15 | | $^\circ C$ |

TYPICAL PERFORMANCE CHARACTERISTICS

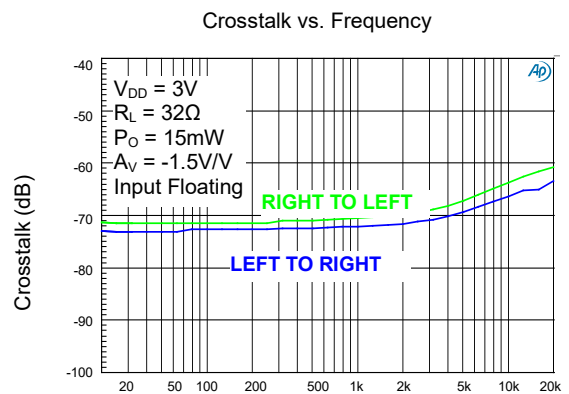
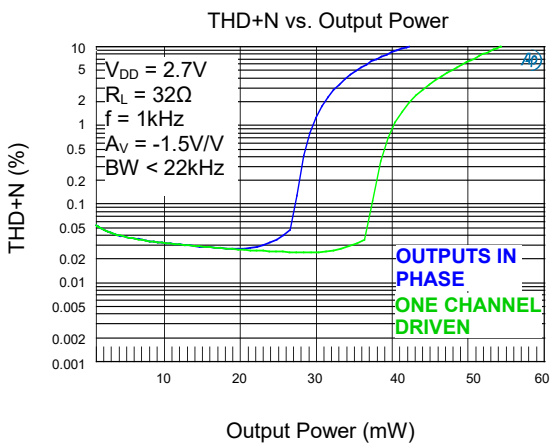
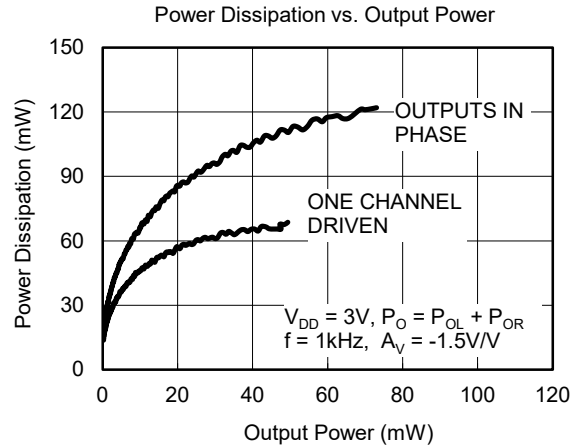
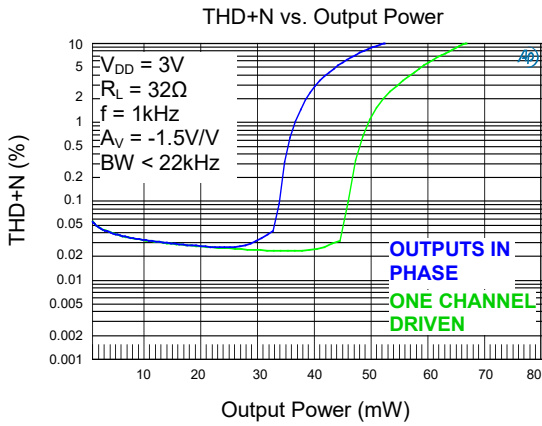
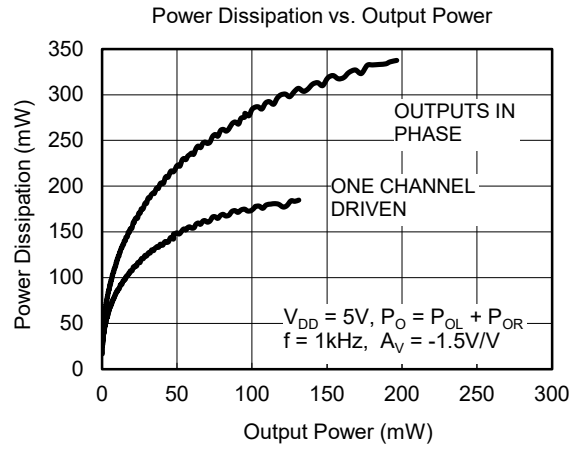
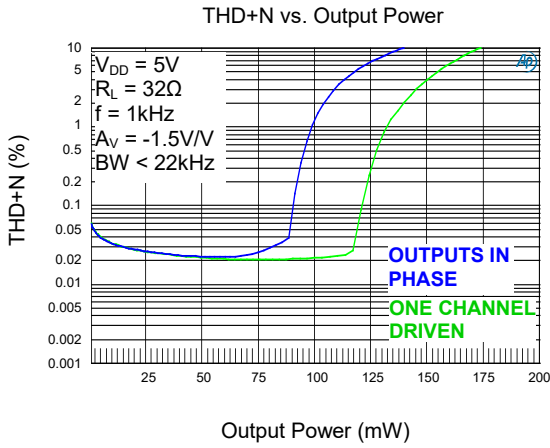

TYPICAL PERFORMANCE CHARACTERISTICS (continued)

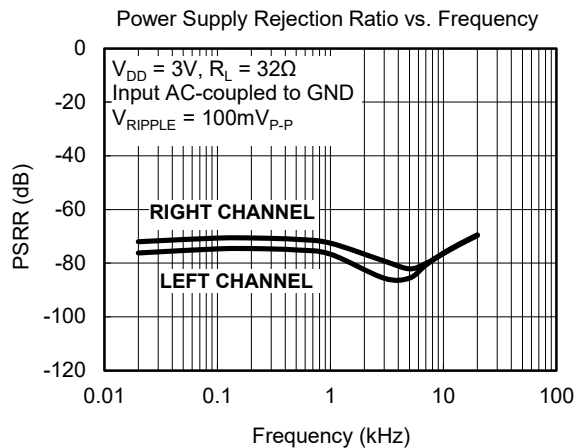
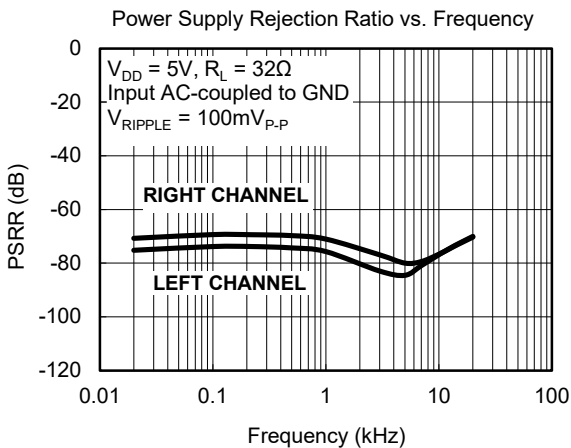
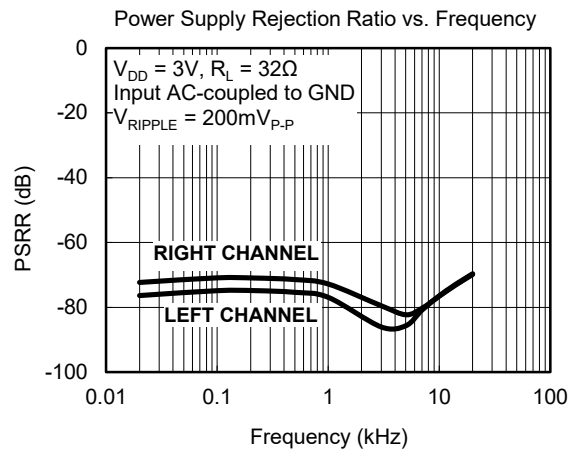
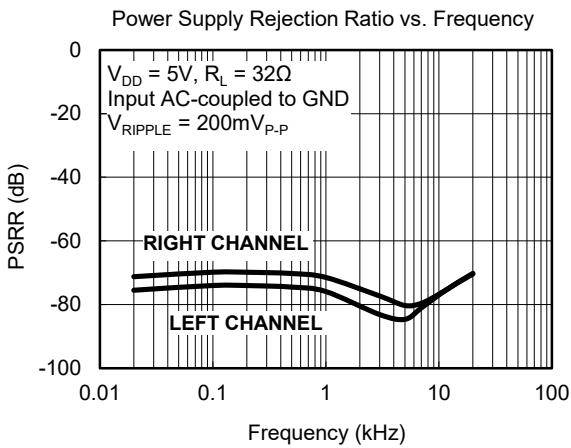
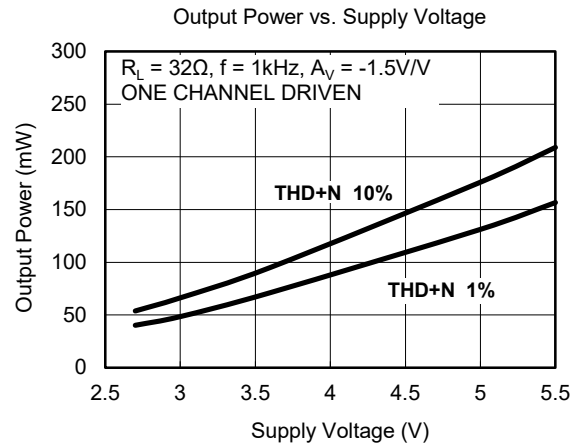
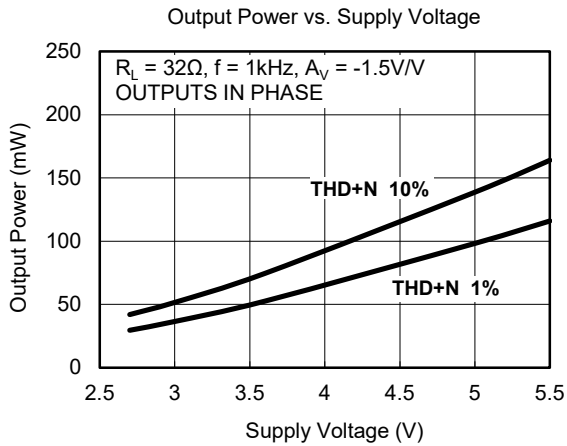

TYPICAL PERFORMANCE CHARACTERISTICS (continued)

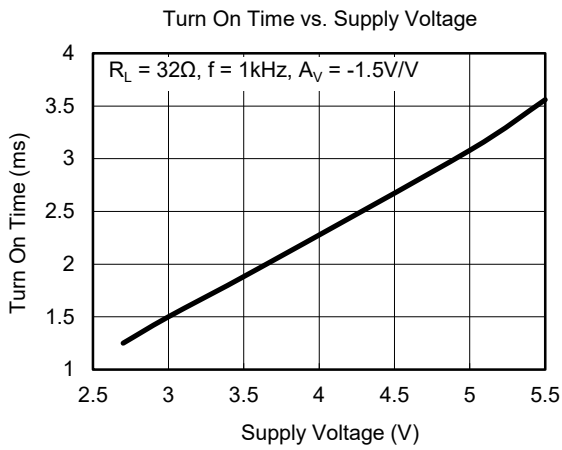
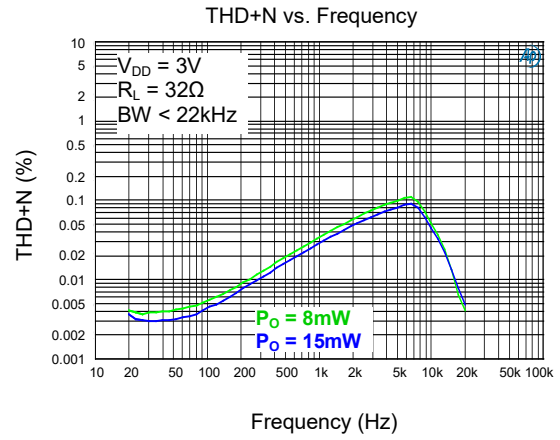
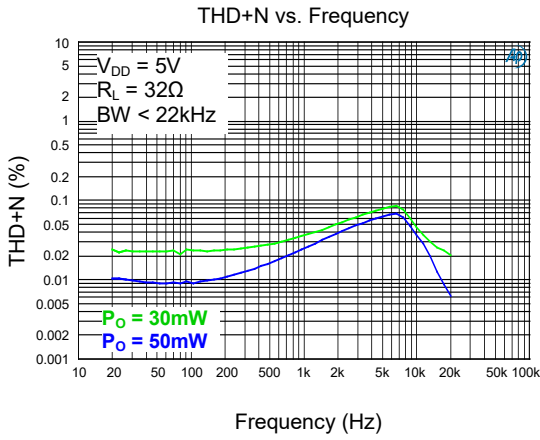

REVISION HISTORY

NOTE: Page numbers for previous revisions may differ from page numbers in the current version.

AUGUST 2013 – REV.A.2 to REV.A.3

Updated TYPICAL PERFORMANCE CHARACTERISTICS (Crosstalk vs. Frequency)..... 5

NOVEMBER 2012 – REV.A.1 to REV.A.2

Added note for Typical Application Circuit..... 8

SEPTEMBER 2012 – REV.A to REV.A.1

Added Tape and Reel Information 10-11

Changes from Original (MARCH 2012) to REV.A

Changed from product preview to production data..... All

PACKAGE OUTLINE DIMENSIONS

TQFN-3×3-12L

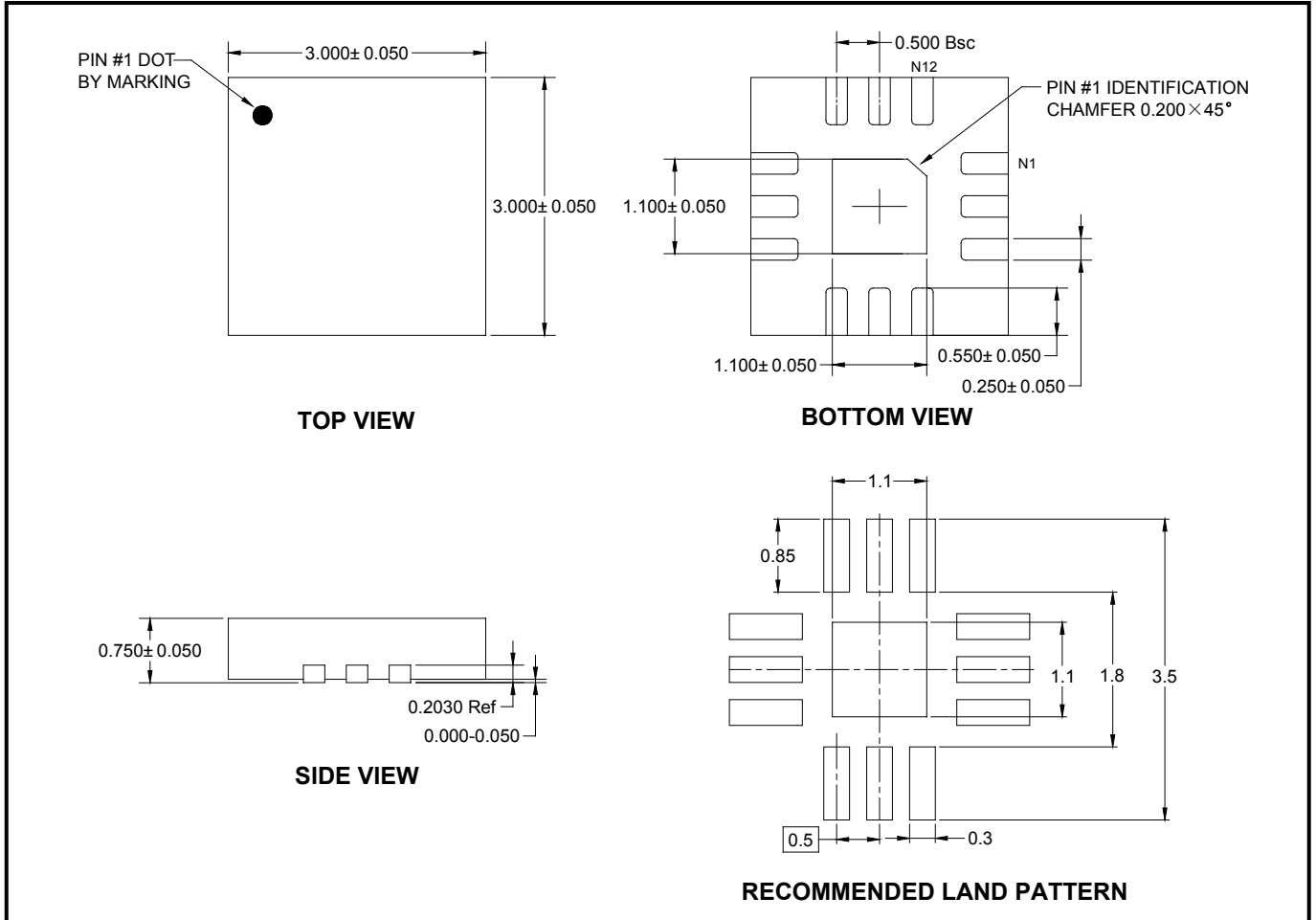

NOTE: All linear dimensions are in millimeters.

PACKAGE INFORMATION

TAPE AND REEL INFORMATION

REEL DIMENSIONS



TAPE DIMENSIONS



NOTE: The picture is only for reference. Please make the object as the standard.

KEY PARAMETER LIST OF TAPE AND REEL

| Package Type | Reel Diameter | Reel Width W1 (mm) | A0 (mm) | B0 (mm) | K0 (mm) | P0 (mm) | P1 (mm) | P2 (mm) | W (mm) | Pin1 Quadrant |
|--------------|---------------|--------------------|---------|---------|---------|---------|---------|---------|--------|---------------|
| TQFN-3×3-12L | 13" | 12.4 | 3.30 | 3.30 | 1.10 | 4.0 | 8.0 | 2.0 | 12.0 | Q1 |

000001

PACKAGE INFORMATION

CARTON BOX DIMENSIONS



NOTE: The picture is only for reference. Please make the object as the standard.

KEY PARAMETER LIST OF CARTON BOX

| Reel Type | Length (mm) | Width (mm) | Height (mm) | Pizza/Carton |
|-----------|-------------|------------|-------------|--------------|
| 13" | 386 | 280 | 370 | 5 |

DD0002

单击下面可查看定价，库存，交付和生命周期等信息

[>>SGMICRO\(圣邦微电子\)](#)