



SGM8604-1/SGM8604-2 SGM8604-3/SGM8604-5

15MHz, High Output Drive, High Precision, Low Noise Operational Amplifiers

GENERAL DESCRIPTION

The SGM8604-1 (single), SGM8604-3 (single with shutdown), SGM8604-2 (dual) and SGM8604-5 (dual with shutdown) are low noise, high precision CMOS operational amplifiers that provide a high output current of 232mA, rail-to-rail output operation from a range of 2.7V to 5.5V single supply. The SGM8604-1/2/3/5 offer low input offset voltage, low input offset voltage drift, wide bandwidth and high output current drive. These devices also can achieve a high 15MHz gain-bandwidth product and a high 7V/ μ s slew rate. The SGM8604-3/5 are both available with shutdown pins that drive the output voltage low.

The SGM8604-1/3 are available in a Green UTDFN-1.45 \times 1-6L package. The SGM8604-2 is available in a Green TDFN-2 \times 3-8AL package. The SGM8604-5 is available in a Green TDFN-3 \times 3-10L package. They operate over an ambient temperature range of -40 $^{\circ}$ C to +125 $^{\circ}$ C.

APPLICATIONS

Battery-Powered Audio Equipment
Audio Output Portable Systems
Hands-Free Mobile Phones (Kits)
Mobile communication Equipment
Wireless Handset Applications
DAC Buffers
Powered Speaker Systems
Transformer/Line Drivers

FEATURES

- **Output Drive Capability:** 232mA
- **Low Input Offset Voltage:** 10 μ V (MAX)
- **Low Input Offset Voltage Drift:** 17nV/ $^{\circ}$ C (TYP)
- **Low Noise:** 22nV/ $\sqrt{\text{Hz}}$ at 1kHz
- **Over-Temperature Protection**
- **Gain-Bandwidth Product:** 15MHz
- **High Slew Rate:** 7V/ μ s
- **Voltage Gain ($R_L = 2\text{k}\Omega$):** 145dB
- **Power Supply Rejection Ratio:** 127dB
- **No Phase Reversal for Overdriven Inputs**
- **Rail-to-Rail Output**
- **Supply Voltage Range:** 2.7V to 5.5V
- **Quiescent Supply Current:**
 - 1.2mA/Amplifier (TYP)
 - 0.1 μ A/Amplifier (TYP) Shutdown Current for SGM8604-3/5
- **Small Packaging:**
 - SGM8604-1 Available in a Green UTDFN-1.45 \times 1-6L
 - SGM8604-2 Available in a Green TDFN-2 \times 3-8AL
 - SGM8604-3 Available in a Green UTDFN-1.45 \times 1-6L
 - SGM8604-5 Available in a Green TDFN-3 \times 3-10L

PACKAGE/ORDERING INFORMATION

MODEL	PACKAGE DESCRIPTION	SPECIFIED TEMPERATURE RANGE	ORDERING NUMBER	PACKAGE MARKING	PACKING OPTION
SGM8604-1	UTDFN-1.45×1-6L	-40°C to +125°C	SGM8604-1XUDL6G/TR	D1X	Tape and Reel, 5000
SGM8604-2	TDFN-2×3-8AL	-40°C to +125°C	SGM8604-2XTDC8G/TR	GD0 XXXX	Tape and Reel, 3000
SGM8604-3	UTDFN-1.45×1-6L	-40°C to +125°C	SGM8604-3XUDL6G/TR	D2X	Tape and Reel, 5000
SGM8604-5	TDFN-3×3-10L	-40°C to +125°C	SGM8604-5XTD10G/TR	SGM 86045D XXXXX	Tape and Reel, 4000

MARKING INFORMATION

NOTE: X = Date Code. XXXX = Date Code. XXXXX = Date Code and Vendor Code.

UTDFN-1.45×1-6L

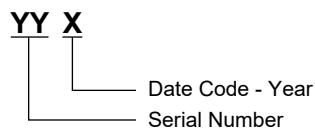

TDFN-2×3-8AL

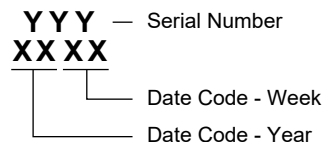

TDFN-3×3-10L

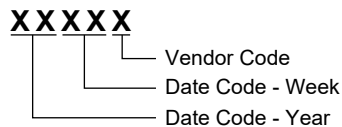

Green (RoHS & HSF): SG Micro Corp defines "Green" to mean Pb-Free (RoHS compatible) and free of halogen substances. If you have additional comments or questions, please contact your SGMICRO representative directly.

ABSOLUTE MAXIMUM RATINGS

- Supply Voltage, +V_S to -V_S 6V
- All Other Pins..... (-V_S - 0.3V) to (+V_S + 0.3V)
- Output Short-Circuit Duration to +V_S or -V_S..... 10s
- Junction Temperature..... +150°C
- Storage Temperature Range -65°C to +150°C
- Lead Temperature (Soldering, 10s)..... +260°C
- ESD Susceptibility
- HBM..... 7000V
- MM..... 400V
- CDM 1000V

RECOMMENDED OPERATING CONDITIONS

- Operating Temperature Range -40°C to +125°C
- Operating Supply Voltage Range 2.7V to 5.5V

OVERSTRESS CAUTION

Stresses beyond those listed in Absolute Maximum Ratings may cause permanent damage to the device. Exposure to

absolute maximum rating conditions for extended periods may affect reliability. Functional operation of the device at any conditions beyond those indicated in the Recommended Operating Conditions section is not implied.

ESD SENSITIVITY CAUTION

This integrated circuit can be damaged by ESD if you don't pay attention to ESD protection. SGMICRO recommends that all integrated circuits be handled with appropriate precautions. Failure to observe proper handling and installation procedures can cause damage. ESD damage can range from subtle performance degradation to complete device failure. Precision integrated circuits may be more susceptible to damage because very small parametric changes could cause the device not to meet its published specifications.

DISCLAIMER

SG Micro Corp reserves the right to make any change in circuit design, or specifications without prior notice.

PIN CONFIGURATIONS

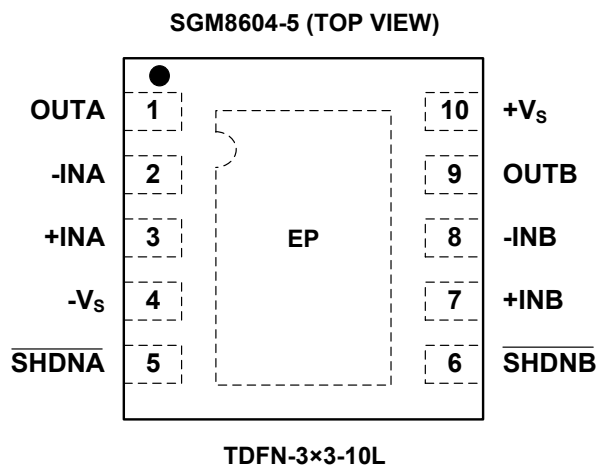
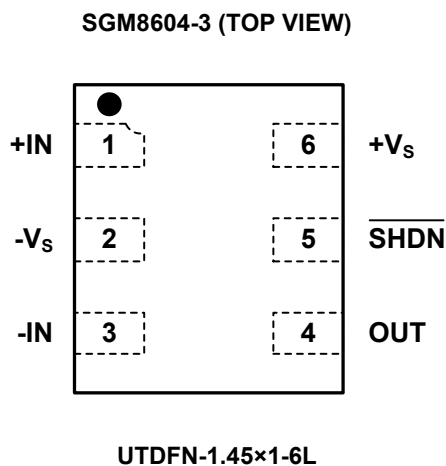
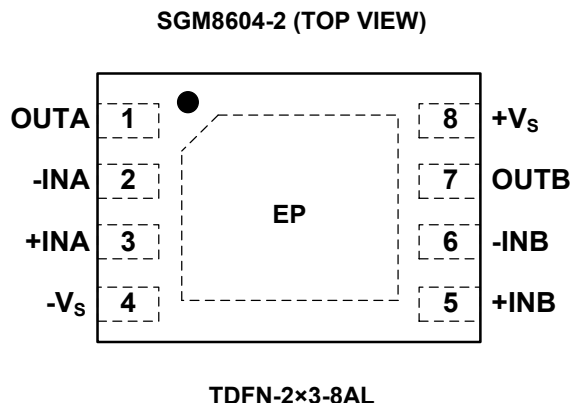
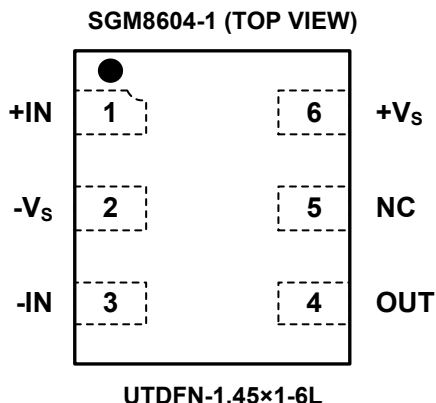

NOTE: For all packages, connect thermal die pad to $-V_s$ or floating. Soldering the thermal pad improves heat dissipation and provides specified performance.

ELECTRICAL CHARACTERISTICS

(At $T_A = +25^\circ\text{C}$, Full = -40°C to $+125^\circ\text{C}$, $V_S = 2.7\text{V}$ to 5V , $-V_S = 0\text{V}$, $V_{CM} = V_S/2$, $V_{OUT} = V_S/2$, $R_L = \infty$ connected to $V_S/2$, $V_{SHDN} = V_S$, unless otherwise noted.)

PARAMETER	SYMBOL	CONDITIONS	TEMP	MIN	TYP	MAX	UNITS	
INPUT CHARACTERISTICS								
Input Offset Voltage	V_{OS}	$V_S = 2.7\text{V}$	$+25^\circ\text{C}$		2.4	8	μV	
		$V_S = 5\text{V}$	$+25^\circ\text{C}$		2.4	10		
Input Offset Voltage Drift	$\Delta V_{OS}/\Delta T$	$V_S = 2.7\text{V}$	Full		25	126	$\text{nV}/^\circ\text{C}$	
		$V_S = 5\text{V}$	Full		17	130		
Input Bias Current	I_B	$V_S = 2.7\text{V}$, $V_{CM} = V_S/2$	$+25^\circ\text{C}$		50		pA	
		$V_S = 5\text{V}$, $V_{CM} = V_S/2$	$+25^\circ\text{C}$		200			
Input Offset Current	I_{OS}	$V_S = 2.7\text{V}$, $V_{CM} = V_S/2$	$+25^\circ\text{C}$		50		pA	
		$V_S = 5\text{V}$, $V_{CM} = V_S/2$	$+25^\circ\text{C}$		200			
Input Common Mode Voltage Range	V_{CM}	Inferred from CMRR test	$+25^\circ\text{C}$	$(-V_S) - 0.1$		$(+V_S) + 0.1$	V	
Common Mode Rejection Ratio	CMRR	$V_S = 2.7\text{V}$, $(-V_S) - 0.1\text{V} < V_{CM} < (+V_S) + 0.1\text{V}$	$+25^\circ\text{C}$	104	120		dB	
			Full	100				
		$V_S = 5\text{V}$, $(-V_S) - 0.1\text{V} < V_{CM} < (+V_S) + 0.1\text{V}$	$+25^\circ\text{C}$	108	120			
			Full	90				
Large Signal Voltage Gain	A_{VOL}	$V_S = 2.7\text{V}$, $(-V_S) + 0.2\text{V} < V_{OUT} < (+V_S) - 0.2\text{V}$	$R_L = 2\text{k}\Omega$	$+25^\circ\text{C}$	112	145	dB	
			$R_L = 200\Omega$	$+25^\circ\text{C}$	109	142		
				Full	110			
				Full	106			
		$V_S = 5\text{V}$, $(-V_S) + 0.2\text{V} < V_{OUT} < (+V_S) - 0.2\text{V}$	$R_L = 2\text{k}\Omega$	$+25^\circ\text{C}$	115	145		
			$R_L = 200\Omega$	$+25^\circ\text{C}$	110	145		
				Full	112			
				Full	108			
OUTPUT CHARACTERISTICS								
Output Voltage Swing from Rail	V_{OUT}	$V_S = 2.7\text{V}$	$R_L = 32\Omega$	$+25^\circ\text{C}$		245	300	mV
				Full			370	
			$R_L = 200\Omega$	$+25^\circ\text{C}$		45	60	
				Full			73	
			$R_L = 2\text{k}\Omega$	$+25^\circ\text{C}$		5	10	
				Full			12	
		$V_S = 5\text{V}$	$R_L = 32\Omega$	$+25^\circ\text{C}$		400	485	mV
				Full			585	
			$R_L = 200\Omega$	$+25^\circ\text{C}$		72	95	
				Full			113	
			$R_L = 2\text{k}\Omega$	$+25^\circ\text{C}$		8	15	
				Full			18	
Short Circuit Current Limit	I_{SC}	$V_S = 2.7\text{V}$	$+25^\circ\text{C}$	85	120	mA		
			Full	58				
		$V_S = 5\text{V}$	$+25^\circ\text{C}$	185	240			
			Full	154				

ELECTRICAL CHARACTERISTICS (continued)

(At $T_A = +25^\circ\text{C}$, Full = -40°C to $+125^\circ\text{C}$, $V_S = 2.7\text{V}$ to 5V , $-V_S = 0\text{V}$, $V_{CM} = V_S/2$, $V_{OUT} = V_S/2$, $R_L = \infty$ connected to $V_S/2$, $V_{SHDN} = V_S$, unless otherwise noted.)

PARAMETER	SYMBOL	CONDITIONS	TEMP	MIN	TYP	MAX	UNITS	
POWER-DOWN DISABLE (SGM8604-3/5 Only)								
Shutdown Supply Current/Amplifier	$I_{Q(SHDN)}$	$V_{SHDN} = 0\text{V}$, $R_L = \infty$	+25°C		0.1	2.5	μA	
SHDN Logic Threshold	V_{IL}	Shutdown mode	+25°C			0.5	V	
	V_{IH}	Normal mode	+25°C	1.6				
SHDN Input Bias Current		$-V_S < V_{SHDN} < V_S$	+25°C		50		pA	
Shutdown Output Impedance	R_{OUT}	$V_{SHDN} = 0\text{V}$	+25°C		10		Ω	
Output Voltage in Shutdown	$V_{OUT(SHDN)}$	$V_{SHDN} = 0\text{V}$, $R_L = 200\Omega$	+25°C		10		mV	
Shutdown Time	t_{SHDN}		+25°C		7		μs	
Enable Delay Time	t_{ENABLE}		+25°C		10		μs	
POWER SUPPLY								
Supply Voltage Range	V_S	Inferred from PSRR test	+25°C	2.7		5.5	V	
Power Supply Rejection Ratio	PSRR		+25°C	102	127		dB	
			Full	94				
Quiescent Supply Current/Amplifier	I_Q	$V_S = 2.7\text{V}$, $V_{CM} = V_S/2$	+25°C		1.1	1.55	mA	
			+25°C		1.2	1.6		
			Full					2.1
DYNAMIC PERFORMANCE								
Gain-Bandwidth Product	GBP	$V_{CM} = V_S/2$	+25°C		15		MHz	
Slew Rate	SR		+25°C		7		V/μs	
Total Harmonic Distortion + Noise	THD+N	$V_S = 5\text{V}$, $R_L = 32\Omega$, $f = 10\text{kHz}$, $V_{OUT} = 2V_{P-P}$, $A_{VCL} = 1\text{V/V}$	+25°C		0.008		%	
Input Capacitance	C_{IN}		+25°C		20		pF	
Channel-to-Channel Isolation		$f = 1\text{kHz}$, $R_L = 100\text{k}\Omega$	+25°C		-125		dB	
Capacitive-Load Stability		$A_{VCL} = 1\text{V/V}$, no sustained oscillations	+25°C		780		pF	
Power-Up Time	t_{ON}		+25°C		50		μs	
NOISE PERFORMANCE								
Input Voltage Noise Density	e_n	$f = 1\text{kHz}$	+25°C		22		nV/√Hz	
		$f = 10\text{kHz}$	+25°C		20			
Input Voltage Noise		$f = 0.1\text{Hz}$ to 10Hz	+25°C		0.5		μV _{P-P}	

TYPICAL PERFORMANCE CHARACTERISTICS

At $T_A = +25^\circ\text{C}$, $V_S = 5.0\text{V}$, unless otherwise noted.

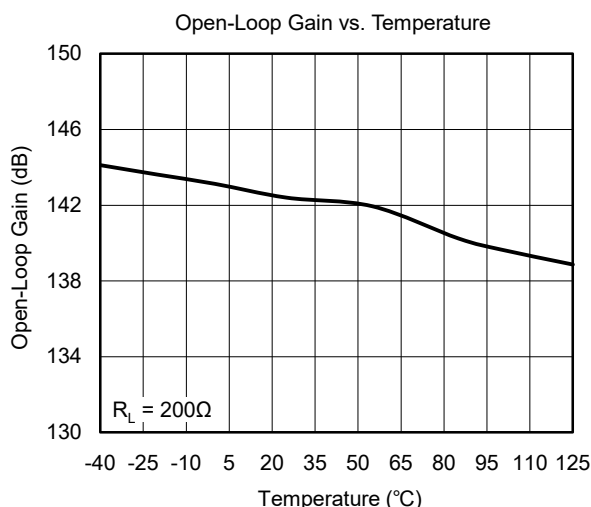
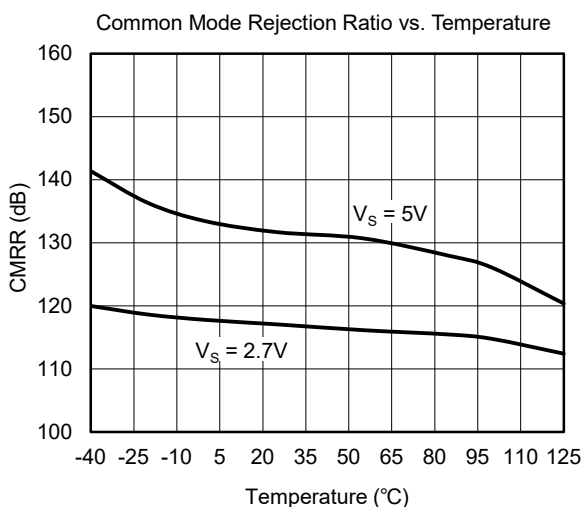
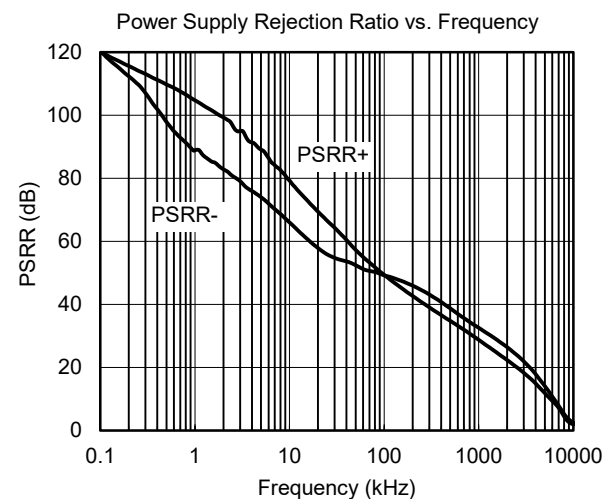
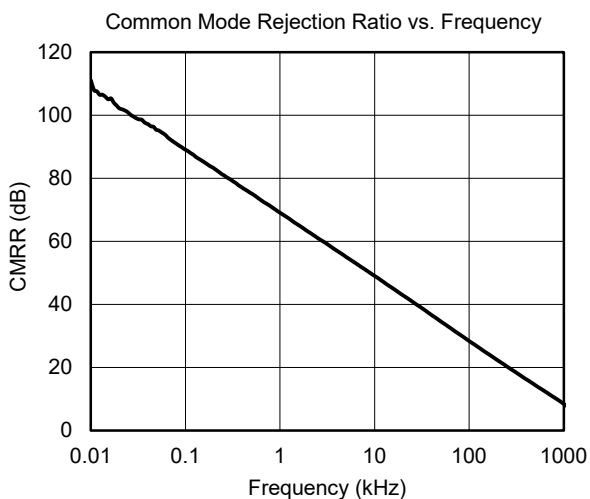
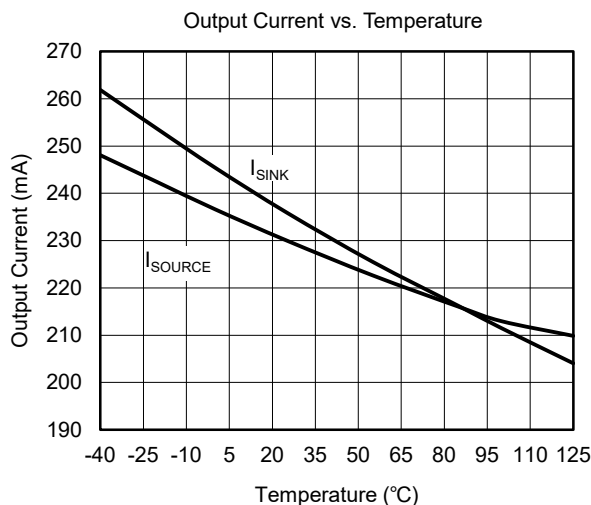
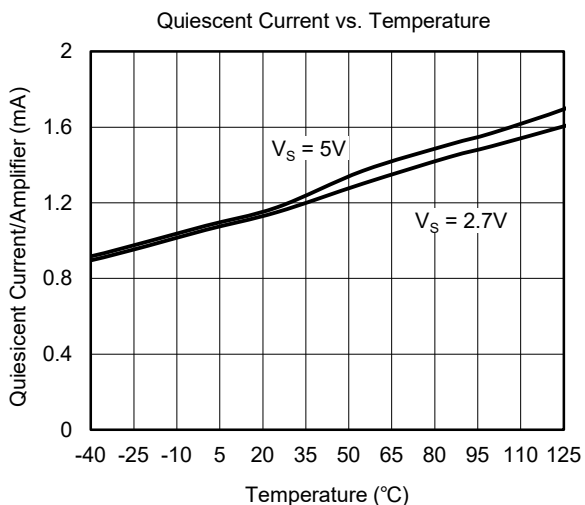

TYPICAL PERFORMANCE CHARACTERISTICS (continued)

At $T_A = +25^\circ\text{C}$, $V_S = 5.0\text{V}$, unless otherwise noted.

Large Signal Step Response

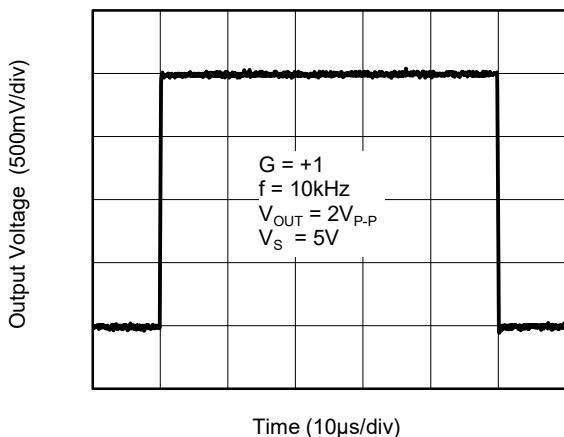

Small Signal Step Response

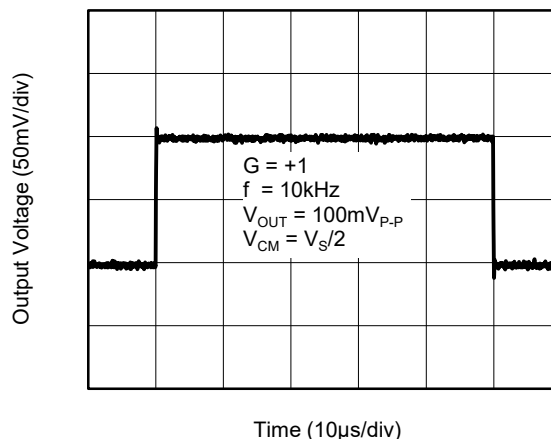

THD+N vs. Output Voltage

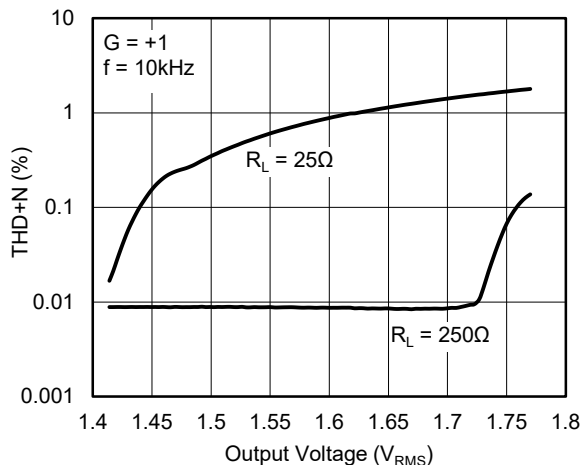

THD+N vs. Output Voltage

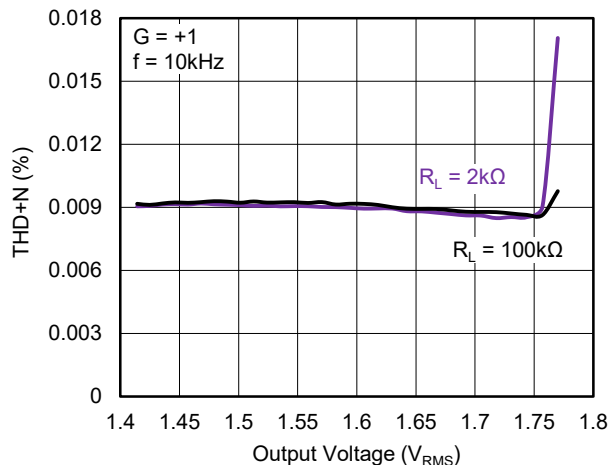

0.1Hz to 10Hz Noise

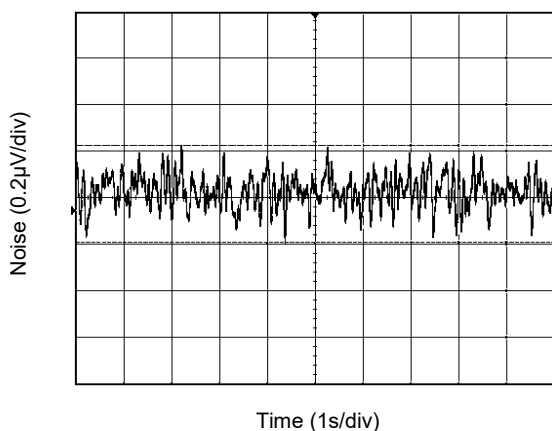

Input Voltage Noise Density

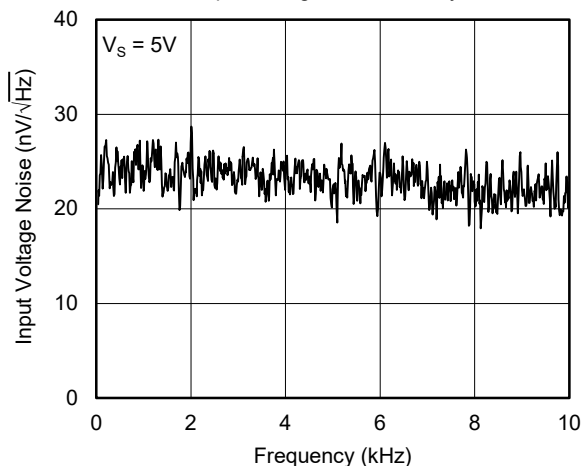

TYPICAL PERFORMANCE CHARACTERISTICS (continued)

At $T_A = +25^\circ\text{C}$, $V_S = 5.0\text{V}$, unless otherwise noted.

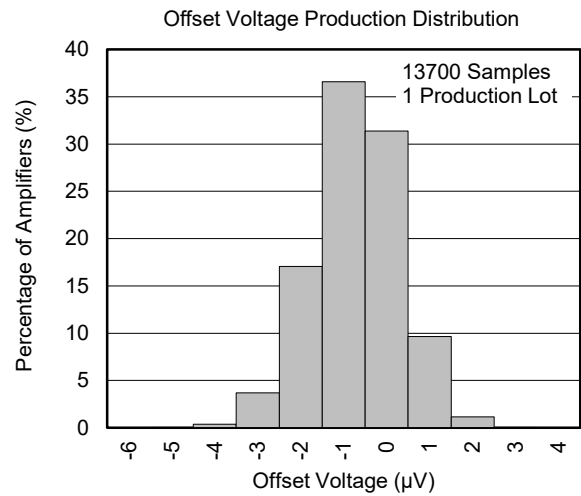
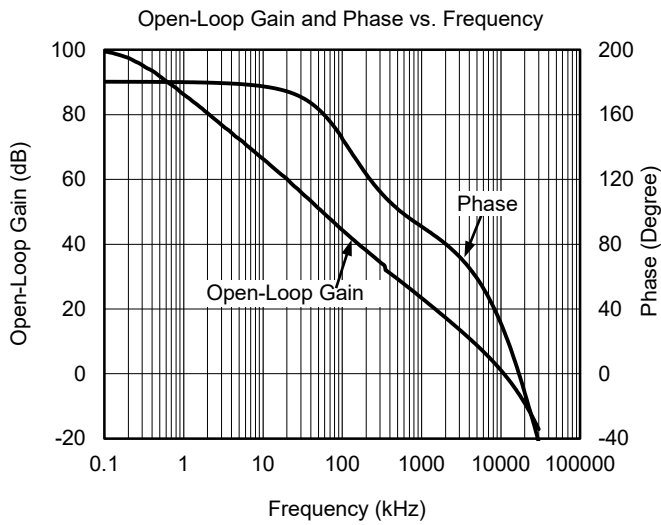

REVISION HISTORY

NOTE: Page numbers for previous revisions may differ from page numbers in the current version.

JANUARY 2019 – REV.A.2 to REV.A.3

Changed Figure 2..... 9

APRIL 2018 – REV.A.1 to REV.A.2

Changed Package/Ordering Information section..... 2

NOVEMBER 2017 – REV.A to REV.A.1

Changed Electrical Characteristics section 4

Changed Typical Performance Characteristics section 7, 8

Changes from Original (DECEMBER 2016) to REV.A

Changed from product preview to production data..... All

PACKAGE OUTLINE DIMENSIONS

UTDFN-1.45×1-6L

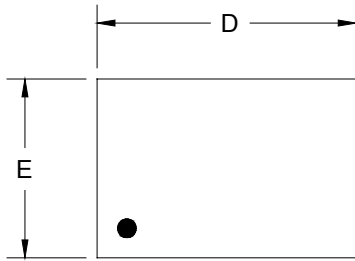

TOP VIEW

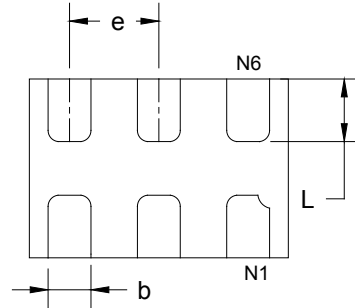

BOTTOM VIEW

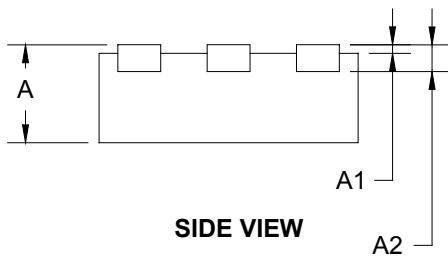

SIDE VIEW

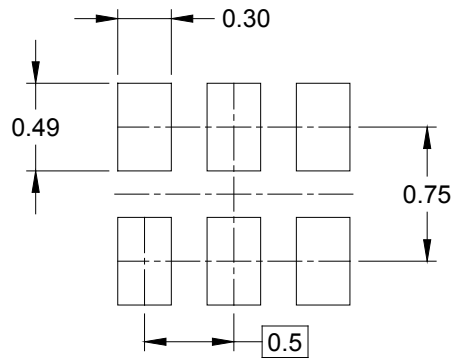

RECOMMENDED LAND PATTERN (Unit: mm)

Symbol	Dimensions In Millimeters		Dimensions In Inches	
	MIN	MAX	MIN	MAX
A	0.450	0.550	0.018	0.022
A1	0.000	0.050	0.000	0.002
A2	0.150 REF		0.006 REF	
D	1.374	1.526	0.054	0.060
E	0.924	1.076	0.036	0.042
b	0.180	0.300	0.007	0.012
e	0.500 TYP		0.020 TYP	
L	0.274	0.426	0.011	0.017

PACKAGE OUTLINE DIMENSIONS

TDFN-2x3-8AL

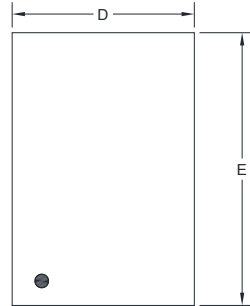

TOP VIEW

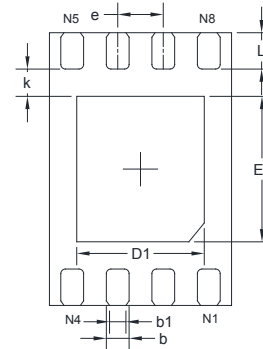

BOTTOM VIEW

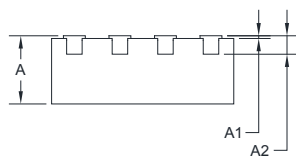

SIDE VIEW

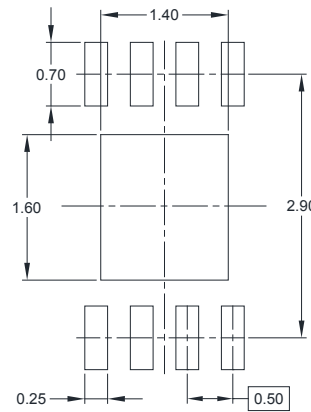

RECOMMENDED LAND PATTERN (Unit: mm)

Symbol	Dimensions In Millimeters		Dimensions In Inches	
	MIN	MAX	MIN	MAX
A	0.700	0.800	0.028	0.031
A1	0.000	0.050	0.000	0.002
A2	0.203 REF		0.008 REF	
D	1.900	2.100	0.075	0.083
D1	1.300	1.500	0.051	0.059
E	2.900	3.100	0.114	0.122
E1	1.500	1.700	0.059	0.067
k	0.300 REF		0.012 REF	
b	0.200	0.300	0.008	0.012
b1	0.180 REF		0.007 REF	
e	0.500 BSC		0.020 BSC	
L	0.300	0.500	0.012	0.020

PACKAGE OUTLINE DIMENSIONS

TDFN-3x3-10L

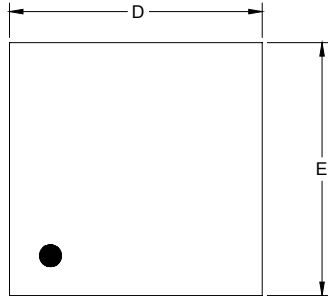

TOP VIEW

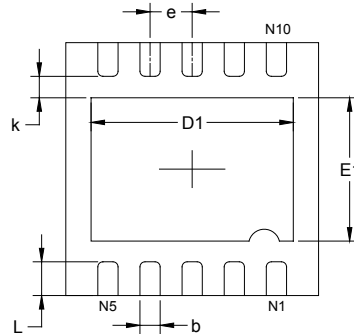

BOTTOM VIEW

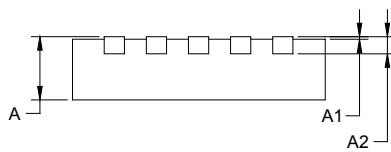

SIDE VIEW

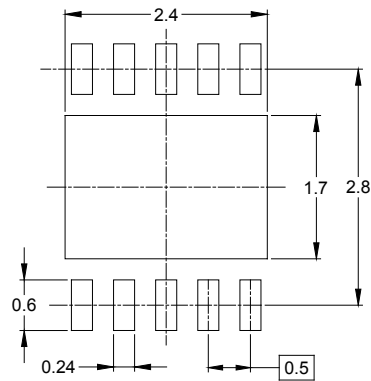

RECOMMENDED LAND PATTERN (Unit: mm)

Symbol	Dimensions In Millimeters		Dimensions In Inches	
	MIN	MAX	MIN	MAX
A	0.700	0.800	0.028	0.031
A1	0.000	0.050	0.000	0.002
A2	0.203 REF		0.008 REF	
D	2.900	3.100	0.114	0.122
D1	2.300	2.600	0.091	0.103
E	2.900	3.100	0.114	0.122
E1	1.500	1.800	0.059	0.071
k	0.200 MIN		0.008 MIN	
b	0.180	0.300	0.007	0.012
e	0.500 TYP		0.020 TYP	
L	0.300	0.500	0.012	0.020

PACKAGE INFORMATION

TAPE AND REEL INFORMATION

REEL DIMENSIONS

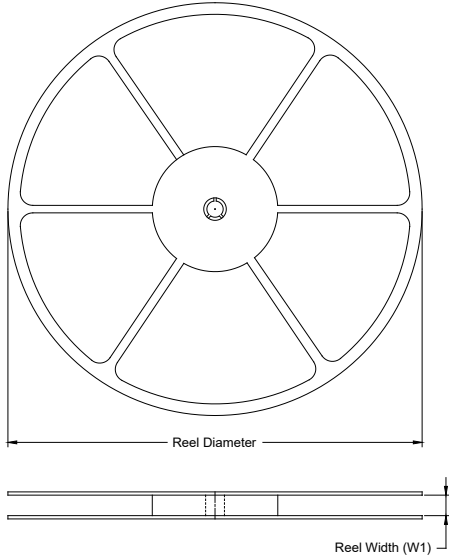

TAPE DIMENSIONS

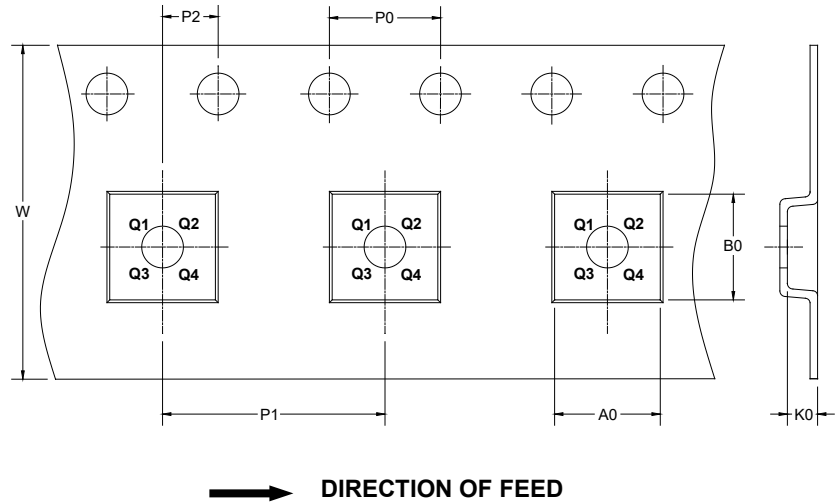

NOTE: The picture is only for reference. Please make the object as the standard.

KEY PARAMETER LIST OF TAPE AND REEL

Package Type	Reel Diameter	Reel Width W1 (mm)	A0 (mm)	B0 (mm)	K0 (mm)	P0 (mm)	P1 (mm)	P2 (mm)	W (mm)	Pin1 Quadrant
UTDFN-1.45×1-6L	7"	9.5	1.15	1.60	0.75	4.0	4.0	2.0	8.0	Q1
TDFN-2×3-8AL	7"	9.5	2.30	3.30	1.10	4.0	4.0	2.0	8.0	Q2
TDFN-3×3-10L	13"	12.4	3.35	3.35	1.13	4.0	8.0	2.0	12.0	Q1

DD0001

PACKAGE INFORMATION

CARTON BOX DIMENSIONS

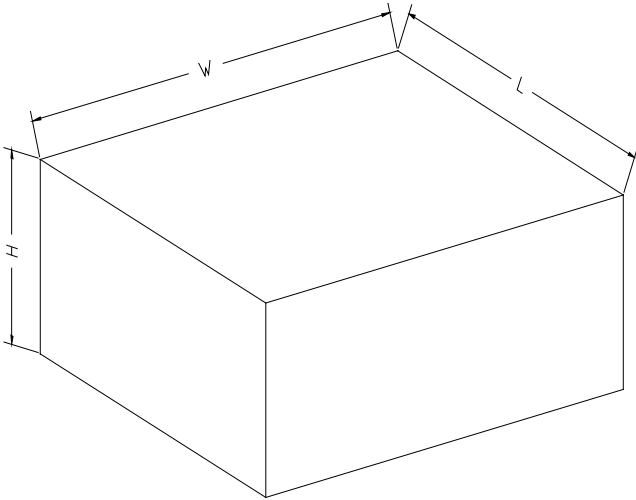

NOTE: The picture is only for reference. Please make the object as the standard.

KEY PARAMETER LIST OF CARTON BOX

Reel Type	Length (mm)	Width (mm)	Height (mm)	Pizza/Carton
7" (Option)	368	227	224	8
7"	442	410	224	18
13"	386	280	370	5

DD0002

单击下面可查看定价，库存，交付和生命周期等信息

[>>SGMICRO\(圣邦微电子\)](#)