

GENERAL DESCRIPTION

The SGM65230 is a 4-Bit 1-of-2 Multiplexer/Demultiplexer and high bandwidth bus switch. It supports rail-to-rail switching on data I/O ports and the power supply range is designed from 2.3V to 3.6V.

The SGM65230 has low on-resistance (R_{ON}) and low data I/O capacitance. These features make the device allow for minimal propagation delay and minimize signal distortion on the data bus.

It is recommended to connect a pull-up resistor between the \overline{OE} pin and V_{CC} pin to ensure high impedance during power-on or power-off. The ability of the driver to absorb current can determine the minimum value of the resistor.

The SGM65230 is designed with an I_{OFF} circuitry. When the device is powered down, the I_{OFF} circuitry can effectively prevent the destructive current backflow, and the SGM65230 has an isolation function in the state of power-off. This feature is widely used in partial-power-down applications.

The SGM65230 is suitable in a variety of applications such as high bandwidth equipment, broadband communications and data-intensive computing systems.

The SGM65230 is available in Green TSSOP-16, SSOP-16 and SOIC-16 packages. It operates over an operating temperature range of -40°C to $+125^{\circ}\text{C}$.

FEATURES

- **Operating Voltage Range (V_{CC}): 2.3V to 3.6V**
- **Data I/Os Support 0V to 5V Signaling Levels: 0.8V, 1.2V, 1.5V, 1.8V, 2.5V, 3.3V and 5V**
- **Rail-to-Rail Switching on Data I/O Ports**
 - ◆ **0V to 5V Signal Passing, $V_{CC} = 3.3V$**
 - ◆ **0V to 3.3V Signal Passing, $V_{CC} = 2.5V$**
- **High-Bandwidth Data Path**
- **Low On-Resistance (R_{ON}): 4 Ω (TYP)**
- **Low Power Consumption (I_{CC}): 0.6mA (TYP)**
- **Fast Switching Frequency (f_{OE}): 20MHz (TYP)**
- **5V Tolerant I/Os with Device Powered Up or Powered Down**
- **Low Input/Output Capacitance Minimizes Loading and Signal Distortion ($C_{IO(OFF)}$): 7pF (TYP)**
- **Data and Control Inputs Provide Undershoot Clamp Diodes**
- **Control Inputs Can Be Driven by TTL or 5V/3.3V CMOS Outputs**
- **Support Partial-Power-Down Mode Operation**
- **Available in Green TSSOP-16, SSOP-16 and SOIC-16 Packages**

APPLICATIONS

Infrastructure Equipment

Wired and Wireless IP Phones

Optical Networking: Video over Fiber and EPON

4-Bit 1-of-2 Multiplexer/Demultiplexer, SGM65230 Low-Voltage High-Bandwidth Bus Switch

PACKAGE/ORDERING INFORMATION

MODEL	PACKAGE DESCRIPTION	SPECIFIED TEMPERATURE RANGE	ORDERING NUMBER	PACKAGE MARKING	PACKING OPTION
SGM65230	TSSOP-16	-40°C to +125°C	SGM65230XTS16G/TR	SGM65230 XTS16 XXXXX	Tape and Reel, 4000
	SSOP-16	-40°C to +125°C	SGM65230XQS16G/TR	SGM65230 XQS16 XXXXX	Tape and Reel, 4000
	SOIC-16	-40°C to +125°C	SGM65230XS16G/TR	SGM65230XS16 XXXXX	Tape and Reel, 2500

MARKING INFORMATION

NOTE: XXXXX = Date Code, Trace Code and Vendor Code.

XXXXX

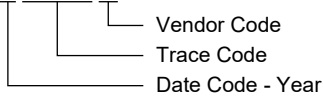

Green (RoHS & HSF): SG Micro Corp defines "Green" to mean Pb-Free (RoHS compatible) and free of halogen substances. If you have additional comments or questions, please contact your SGMICRO representative directly.

ABSOLUTE MAXIMUM RATINGS

Supply Voltage Range, V_{CC} -0.3V to 4.6V
 Control Input Voltage ⁽¹⁾, V_{IN} -0.3V to 7V
 Switch I/O Voltage ⁽¹⁾⁽²⁾, $V_{I/O}$ -0.3V to 7V
 Switch I/O Current, $I_{I/O}$ ± 64 mA (MAX)
 Junction Temperature +150°C
 Storage Temperature Range -65°C to +150°C
 Lead Temperature (Soldering, 10s) +260°C
 ESD Susceptibility
 HBM 3000V
 CDM 1000V

RECOMMENDED OPERATING CONDITIONS⁽³⁾

Supply Voltage Range, V_{CC} 2.3V to 3.6V
 Control Input Voltage, V_{IN} 0V to 5.5V
 Switch I/O Voltage, $V_{I/O}$ 0V to 5.5V
 Operating Temperature Range -40°C to +125°C

NOTES:

- All voltages are respected to GND, unless otherwise noted.
- V_I and V_O are respectively used to represent $V_{I/O}$ under specific conditions.
- In order to ensure the normal operation of the device, all unused control inputs must be kept on V_{CC} or GND.

OVERSTRESS CAUTION

Stresses beyond those listed in Absolute Maximum Ratings may cause permanent damage to the device. Exposure to absolute maximum rating conditions for extended periods may affect reliability. Functional operation of the device at any conditions beyond those indicated in the Recommended Operating Conditions section is not implied.

ESD SENSITIVITY CAUTION

This integrated circuit can be damaged if ESD protections are not considered carefully. SGMICRO recommends that all integrated circuits be handled with appropriate precautions. Failure to observe proper handling and installation procedures can cause damage. ESD damage can range from subtle performance degradation to complete device failure. Precision integrated circuits may be more susceptible to damage because even small parametric changes could cause the device not to meet the published specifications.

DISCLAIMER

SG Micro Corp reserves the right to make any change in circuit design, or specifications without prior notice.

PIN CONFIGURATIONS

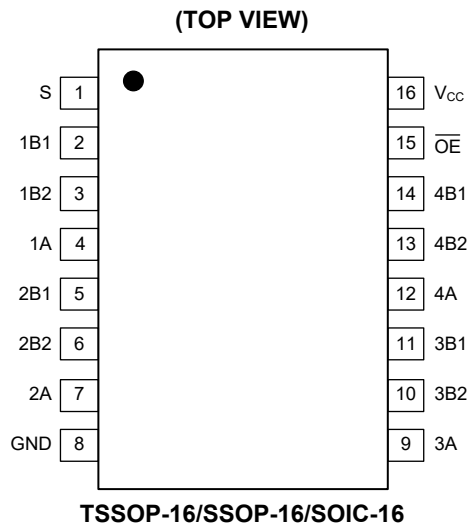

PIN DESCRIPTION

PIN	NAME	I/O	FUNCTION
1	S	I	Select Control Input.
2	1B1	I/O	I/O 1 of Channel 1.
3	1B2	I/O	I/O 2 of Channel 1.
4	1A	I/O	Common Terminal of Channel 1.
5	2B1	I/O	I/O 1 of Channel 2.
6	2B2	I/O	I/O 2 of Channel 2.
7	2A	I/O	Common Terminal of Channel 2.
8	GND	—	Ground.
9	3A	I/O	Common Terminal of Channel 3.
10	3B2	I/O	I/O 2 of Channel 3.
11	3B1	I/O	I/O 1 of Channel 3.
12	4A	I/O	Common Terminal of Channel 4.
13	4B2	I/O	I/O 2 of Channel 4.
14	4B1	I/O	I/O 1 of Channel 4.
15	$\overline{\text{OE}}$	I	Enable Control Input (Active Low).
16	V _{CC}	—	Positive Power Supply.

PACKAGE OUTLINE DIMENSIONS

TSSOP-16

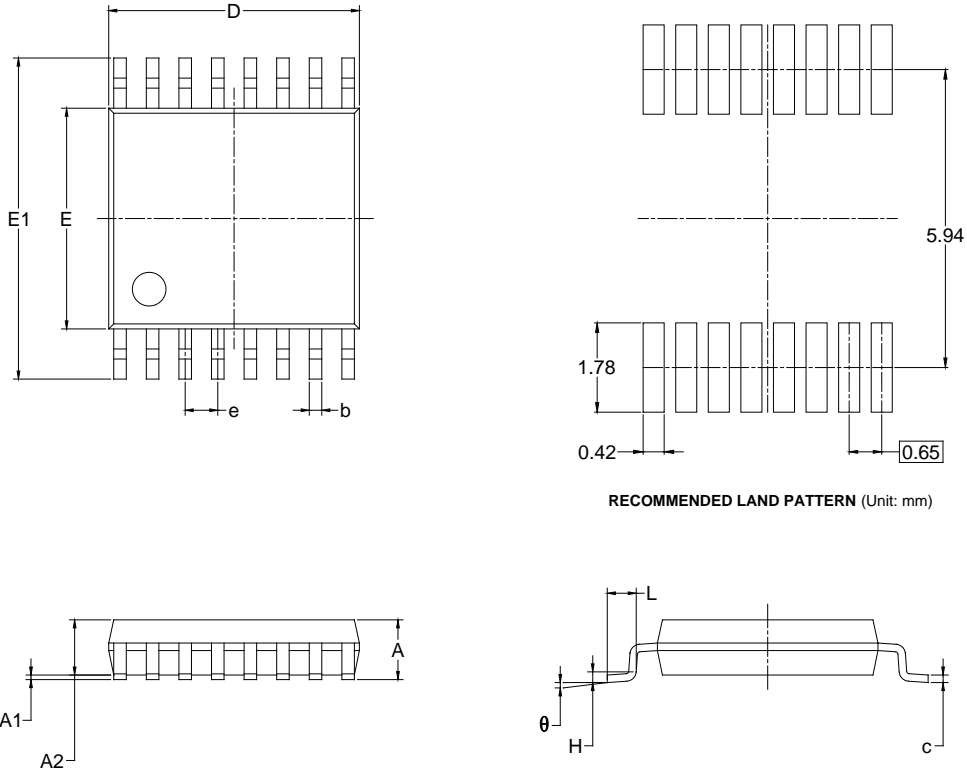

RECOMMENDED LAND PATTERN (Unit: mm)

Symbol	Dimensions In Millimeters		Dimensions In Inches	
	MIN	MAX	MIN	MAX
A		1.200		0.047
A1	0.050	0.150	0.002	0.006
A2	0.800	1.050	0.031	0.041
b	0.190	0.300	0.007	0.012
c	0.090	0.200	0.004	0.008
D	4.860	5.100	0.191	0.201
E	4.300	4.500	0.169	0.177
E1	6.200	6.600	0.244	0.260
e	0.650 BSC		0.026 BSC	
L	0.500	0.700	0.02	0.028
H	0.25 TYP		0.01 TYP	
θ	1°	7°	1°	7°

- NOTES:
1. Body dimensions do not include mode flash or protrusion.
 2. This drawing is subject to change without notice.

PACKAGE OUTLINE DIMENSIONS

SSOP-16

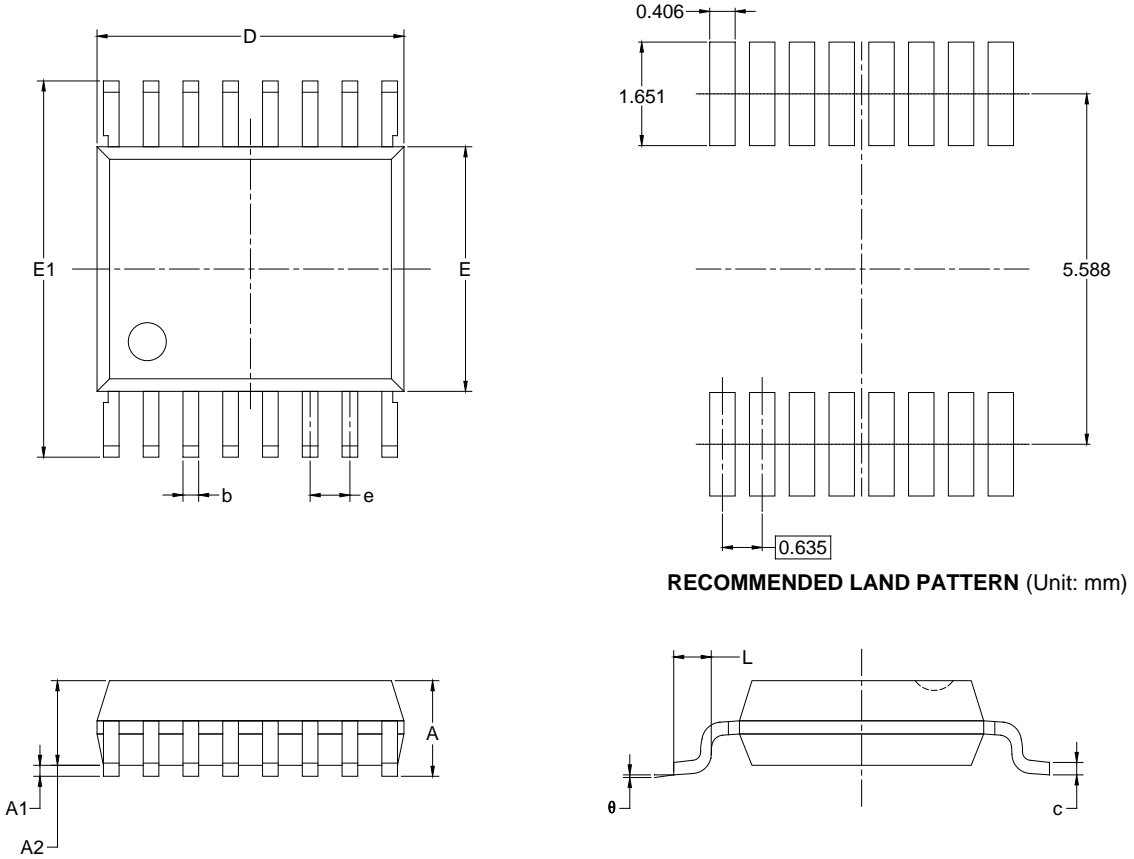

RECOMMENDED LAND PATTERN (Unit: mm)

Symbol	Dimensions In Millimeters		Dimensions In Inches	
	MIN	MAX	MIN	MAX
A	1.350	1.750	0.053	0.069
A1	0.100	0.250	0.004	0.010
A2	1.350	1.550	0.053	0.061
b	0.200	0.300	0.008	0.012
c	0.170	0.250	0.007	0.010
D	4.700	5.100	0.185	0.200
E	3.800	4.000	0.150	0.157
E1	5.800	6.200	0.228	0.244
e	0.635 BSC		0.025 BSC	
L	0.400	1.270	0.016	0.050
θ	0°	8°	0°	8°

NOTES:
 1. Body dimensions do not include mode flash or protrusion.
 2. This drawing is subject to change without notice.

PACKAGE OUTLINE DIMENSIONS

SOIC-16

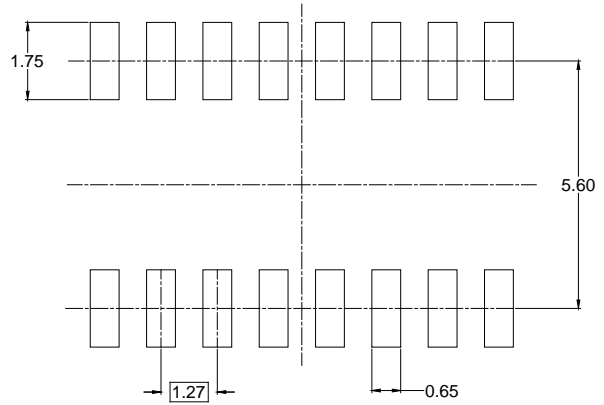
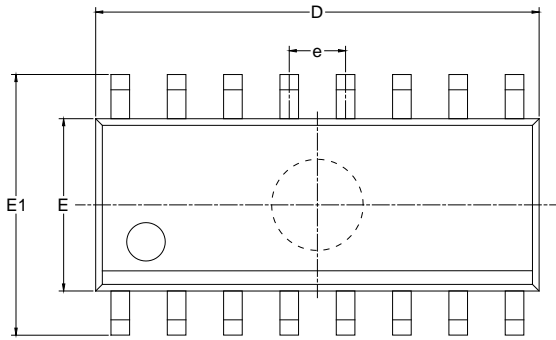

RECOMMENDED LAND PATTERN (Unit: mm)

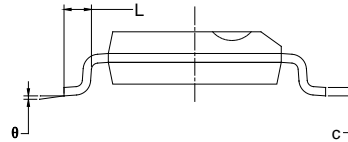
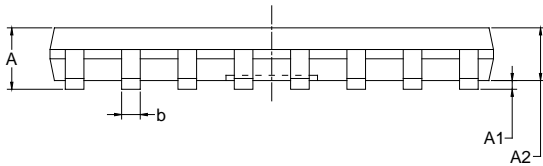

Symbol	Dimensions In Millimeters		Dimensions In Inches	
	MIN	MAX	MIN	MAX
A	1.350	1.750	0.053	0.069
A1	0.100	0.250	0.004	0.010
A2	1.350	1.550	0.053	0.061
b	0.330	0.510	0.013	0.020
c	0.170	0.250	0.006	0.010
D	9.800	10.200	0.386	0.402
E	3.800	4.000	0.150	0.157
E1	5.800	6.200	0.228	0.244
e	1.27 BSC		0.050 BSC	
L	0.400	1.270	0.016	0.050
θ	0°	8°	0°	8°

NOTES:

1. Body dimensions do not include mode flash or protrusion.
2. This drawing is subject to change without notice.

TAPE AND REEL INFORMATION

REEL DIMENSIONS



TAPE DIMENSIONS

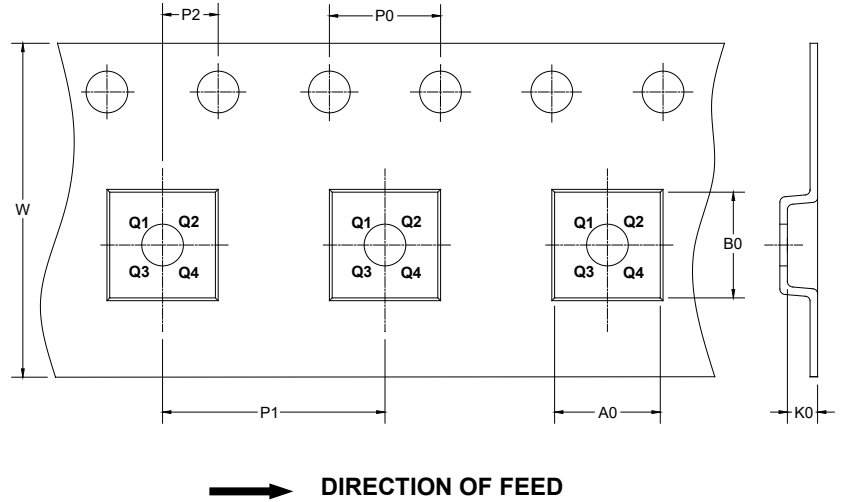

NOTE: The picture is only for reference. Please make the object as the standard.

KEY PARAMETER LIST OF TAPE AND REEL

Package Type	Reel Diameter	Reel Width W1 (mm)	A0 (mm)	B0 (mm)	K0 (mm)	P0 (mm)	P1 (mm)	P2 (mm)	W (mm)	Pin1 Quadrant	Assembly House
TSSOP-16	13"	16.4	6.80	5.40	1.60	4.0	8.0	2.0	16.0	Q1	ANST
TSSOP-16	13"	12.4	6.80	5.40	1.30	4.0	8.0	2.0	12.0	Q1	HTTS
SSOP-16	13"	12.4	6.40	5.40	2.10	4.0	8.0	2.0	12.0	Q1	-
SOIC-16	13"	16.4	6.50	10.30	2.10	4.0	8.0	2.0	16.0	Q1	-

D00001

PACKAGE INFORMATION

CARTON BOX DIMENSIONS



NOTE: The picture is only for reference. Please make the object as the standard.

KEY PARAMETER LIST OF CARTON BOX

Reel Type	Length (mm)	Width (mm)	Height (mm)	Pizza/Carton
13"	386	280	370	5

DD0002

单击下面可查看定价，库存，交付和生命周期等信息

[>>SGMICRO\(圣邦微电子\)](#)