

GENERAL DESCRIPTION

The SGM6010 is a synchronous, buck DC/DC converter with a range of 3V to 5.5V input voltage. This device is capable to provide a 3A continuous output current. It operates with a programmable frequency range of 300kHz to 2MHz. The SGM6010 is highly efficient with peak efficiency at 95% when in operation. The 100% duty cycle could make the lowest dropout.

The forced continuous pulse width modulation (PWM) mode operation could decrease the ripple voltage to the lowest level and reduce noise and RF interference as well. No external power MOSFETs and Schottky diode are required because of the internal synchronous low on-resistance power switches. The external compensation can improve the transient response across the loads and output capacitors.

The SGM6010 is available in a Green TDFN-3×3-10L package. It is rated over the -40°C to +85°C temperature range.

FEATURES

- 3V to 5.5V Input Voltage Range
- Up to 95% High Efficiency
- 120mΩ Low $R_{DS(ON)}$ Internal Switches
- 300kHz to 2MHz Programmable Frequency
- 3A Output Current
- 0.8V Reference Allows Low Output Voltages
- Shutdown Current: 2μA (MAX)
- 100% Duty Cycle for Lowest Dropout
- Forced Continuous PWM Mode Operation
- No External Power MOSFETs and Schottky Diode Required
- Excellent Line and Load Transient Responses
- -40°C to +85°C Operating Temperature Range
- Available in a Green TDFN-3×3-10L Package

APPLICATIONS

- Digital Book Readers
- Digital Cameras
- Portable Instruments
- Wireless and DSL Modems
- Battery-Powered Systems
- Microprocessor, DSP Power Supplies

TYPICAL APPLICATION

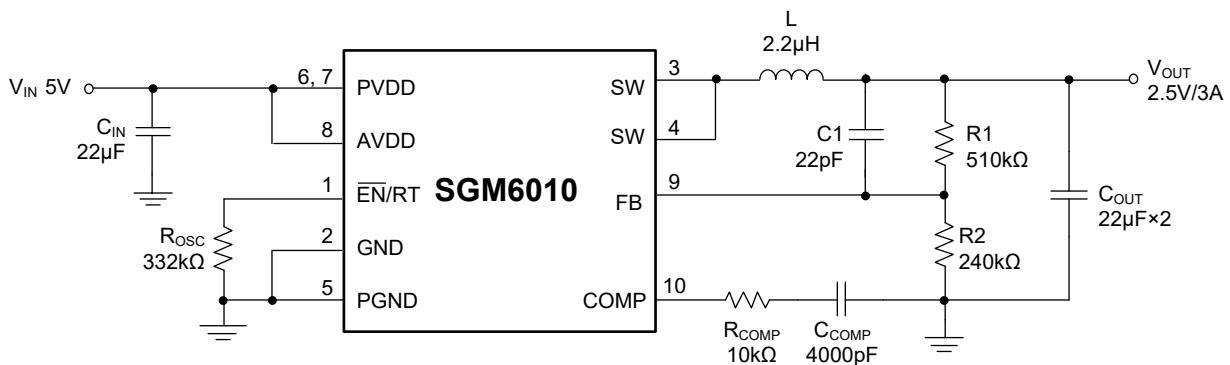

Figure 1. Typical Application Circuit

PACKAGE/ORDERING INFORMATION

MODEL	PACKAGE DESCRIPTION	SPECIFIED TEMPERATURE RANGE	ORDERING NUMBER	PACKAGE MARKING	PACKING OPTION
SGM6010	TDFN-3x3-10L	-40°C to +85°C	SGM6010YTD10G/TR	SGM 6010D XXXXX	Tape and Reel, 3000

MARKING INFORMATION

NOTE: XXXXX = Date Code and Vendor Code.

XXXXX

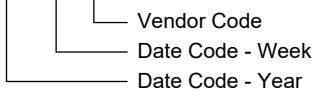

Green (RoHS & HSF): SG Micro Corp defines "Green" to mean Pb-Free (RoHS compatible) and free of halogen substances. If you have additional comments or questions, please contact your SGMICRO representative directly.

ABSOLUTE MAXIMUM RATINGS

- Input Supply Voltage..... -0.3V to 6V
- Other I/O Voltages -0.3V to (AVDD/PVDD + 0.3V)
- SW Switch Voltage -0.3V to (PVDD + 0.3V)
- Peak SW Sink and Source Current..... 3.6A
- Power Dissipation, P_D @ T_A = +25°C
- TDFN-3x3-10L..... 2.2W
- Package Thermal Resistance
- TDFN-3x3-10L, θ_{JA}..... 45°C/W
- Junction Temperature..... +150°C
- Storage Temperature Range -65°C to +150°C
- Lead Temperature (Soldering, 10s)..... +260°C
- ESD Susceptibility
- HBM..... 2000V
- MM..... 200V

RECOMMENDED OPERATING CONDITIONS

- Operating Temperature Range -40°C to +85°C

OVERSTRESS CAUTION

Stresses beyond those listed in Absolute Maximum Ratings may cause permanent damage to the device. Exposure to absolute maximum rating conditions for extended periods may affect reliability. Functional operation of the device at any conditions beyond those indicated in the Recommended Operating Conditions section is not implied.

ESD SENSITIVITY CAUTION

This integrated circuit can be damaged if ESD protections are not considered carefully. SGMICRO recommends that all integrated circuits be handled with appropriate precautions. Failure to observe proper handling and installation procedures can cause damage. ESD damage can range from subtle performance degradation to complete device failure. Precision integrated circuits may be more susceptible to damage because even small parametric changes could cause the device not to meet the published specifications.

DISCLAIMER

SG Micro Corp reserves the right to make any change in circuit design, or specifications without prior notice.

PIN CONFIGURATION

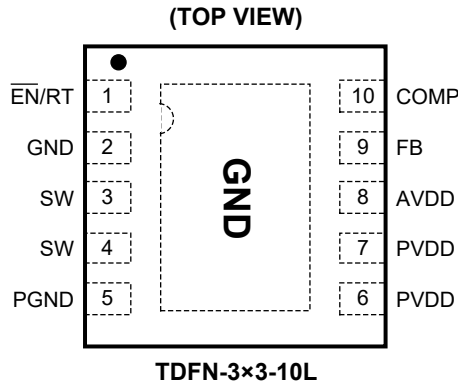

PIN DESCRIPTION

PIN	NAME	FUNCTION
1	$\overline{\text{EN/RT}}$	Oscillator Resistor Input. Put a resistor between this pin and ground to program the switching frequency. If this pin connects to AVDD, the device will be shut down.
2	GND	Signal Ground. This pin connects all the small-signal components and compensation components which connect to the PGND conversely.
3,4	SW	Internal Power MOSFET Switches Output. Put an inductor to this pin.
5	PGND	Power Ground. This pin is connected to the negative terminal of C_{IN} and C_{OUT} with the shortest path.
6,7	PVDD	Power Input Supply. Put a capacitor to decouple this pin to PGND.
8	AVDD	Analog Signal Power Supply. Put a capacitor to decouple this pin to GND. Normally AVDD is equal to PVDD.
9	FB	Feedback Pin. Feedback voltage of a resistive divider connected across the output is received by this pin.
10	COMP	Error Amplifier Compensation Point. To stabilize the control loop, the external compensation elements are connected to this pin.
Exposed Pad	GND	Power Ground Exposed Pad. Must be connected to GND plane.

ELECTRICAL CHARACTERISTICS(V_{IN} = 3.3V, T_A = -40°C to +85°C, typical values are at T_A = +25°C, unless otherwise noted.)

PARAMETER	SYMBOL	CONDITIONS	MIN	TYP	MAX	UNITS
Input Voltage Range	V _{IN}		3		5.5	V
Feedback Reference Voltage	V _{REF}		0.772	0.8	0.828	V
Feedback Input Bias Current	I _{FB}		-0.4	0.1	0.4	μA
Input DC Bias Current	Active Mode	V _{FB} = 0.78V, R _{OSC} = 332kΩ, Not Switching		410	600	μA
	Shutdown				2.0	
Output Voltage Line Regulation	ΔV _{OUT}	V _{IN} = 2.6V to 5.5V		0.1		%/V
Output Voltage Load Regulation	V _{LOADREG}	V _{IN} = 5V, V _{OUT} = 2.5V, I _{LOAD} = 0 to 3A		0.15		%/A
Error Amplifier Transconductance	g _m			800		μS
Current Sense Trans-Resistance	R _{OSC}			0.4		Ω
Oscillator Frequency	f _{OSC}	R _{OSC} = 332kΩ, T _A = 25°C	0.75	1	1.25	MHz
		Switching Frequency	0.3		2	MHz
Switch On Resistance, High	R _{PMOS}	I _{SW} = 0.5A, T _A = 25°C		120	210	mΩ
Switch On Resistance, Low	R _{NMOS}	I _{SW} = 0.5A, T _A = 25°C		100	160	mΩ
Peak Current Limit	I _{PK}	T _A = 25°C	3.3	3.5		A
Under-Voltage Lockout Threshold	UVLO	V _{DD} Rising		2.2		V
		V _{DD} Falling		2.05		
Shutdown Threshold				V _{IN} - 0.7	V _{IN} - 0.4	V

TYPICAL PERFORMANCE CHARACTERISTICS

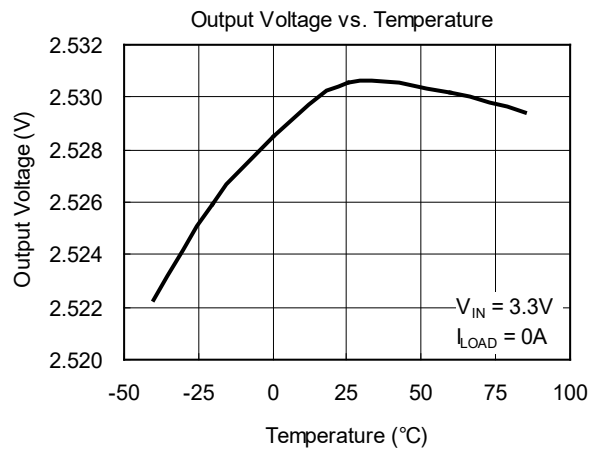
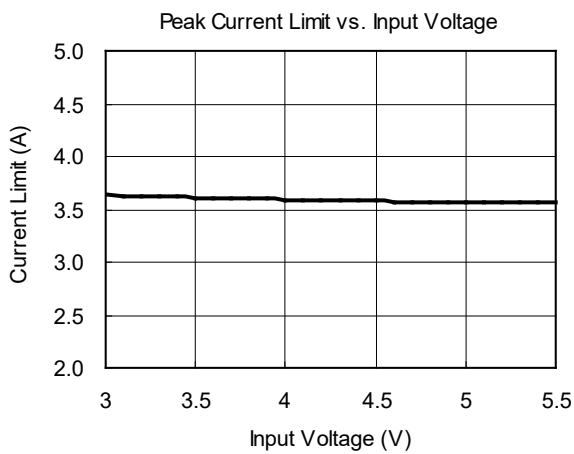
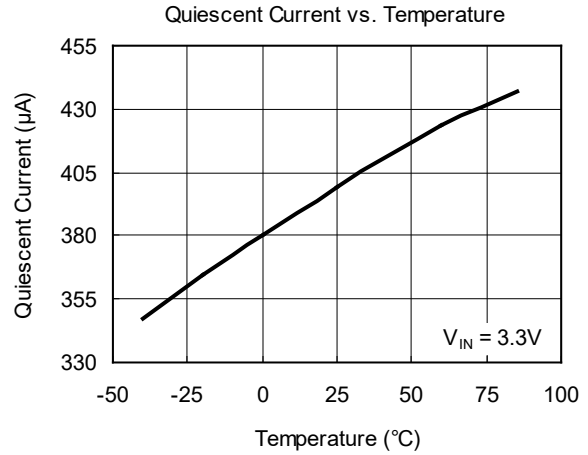
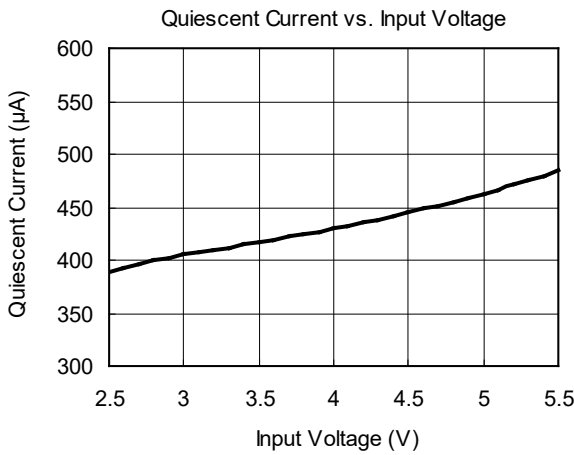
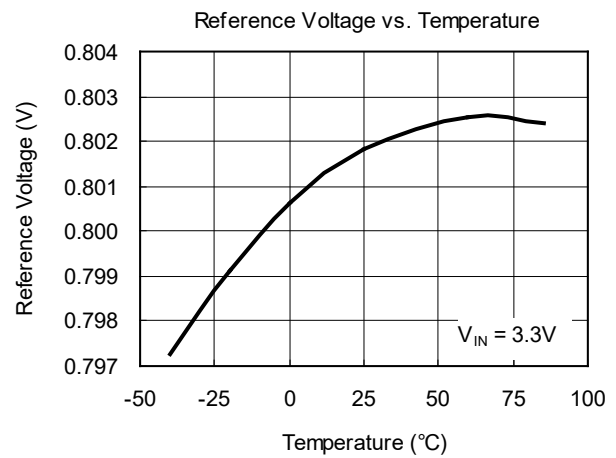
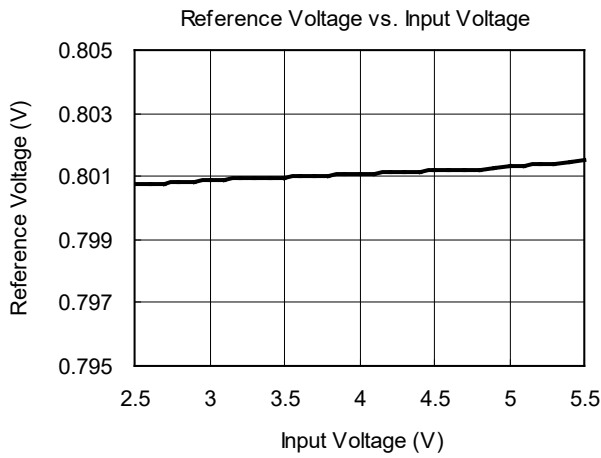

TYPICAL PERFORMANCE CHARACTERISTICS (continued)

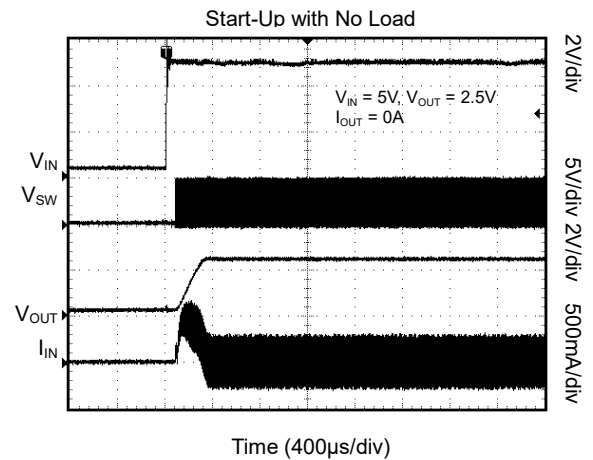
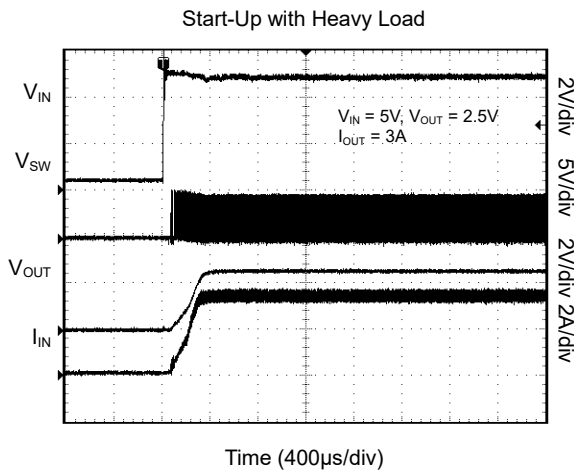
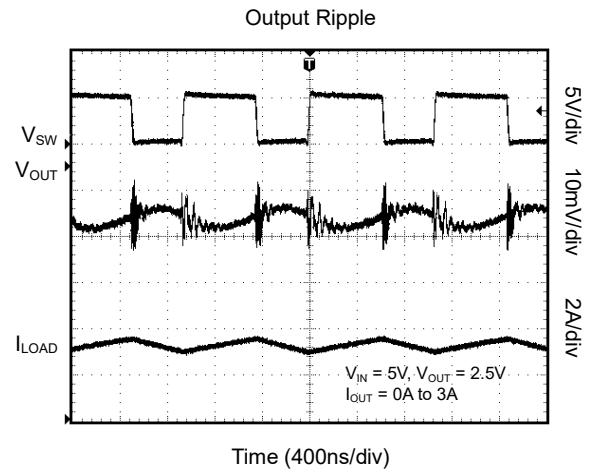
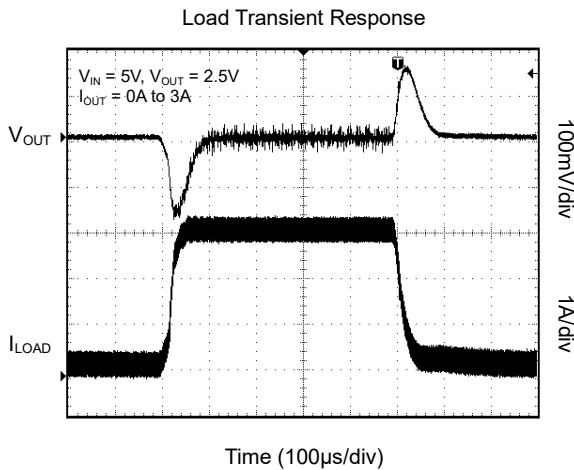
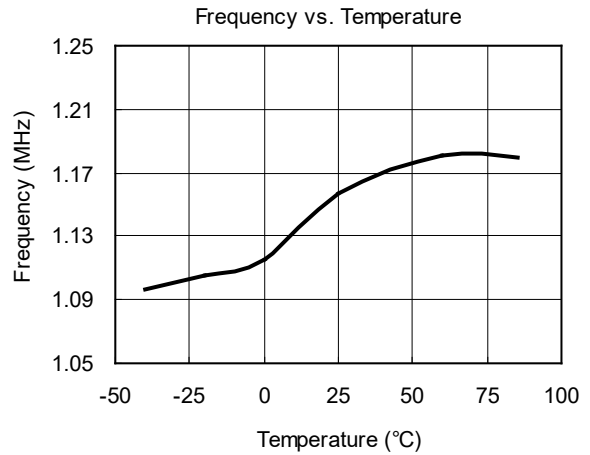
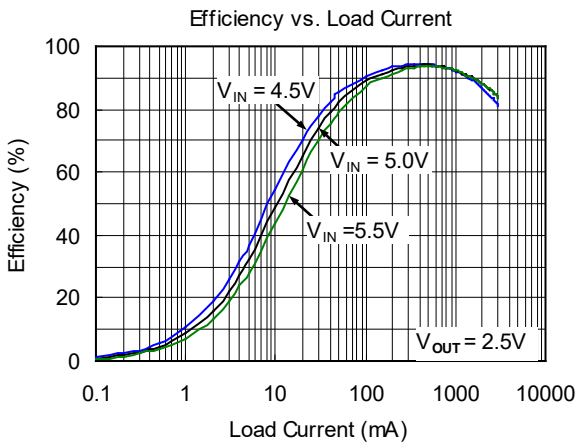

REVISION HISTORY

NOTE: Page numbers for previous revisions may differ from page numbers in the current version.

Changes from Original (APRIL 2014) to REV.A	Page
Changed from product preview to production data.....	All

PACKAGE OUTLINE DIMENSIONS

TDFN-3x3-10L

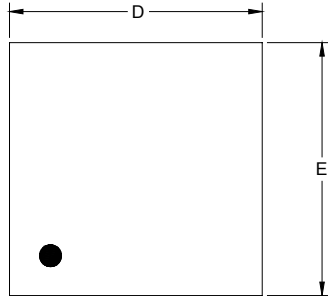

TOP VIEW

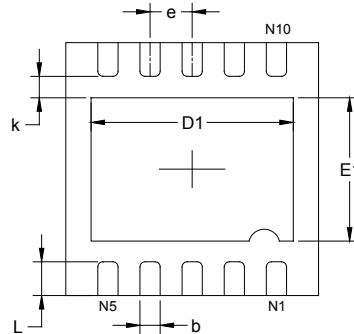

BOTTOM VIEW

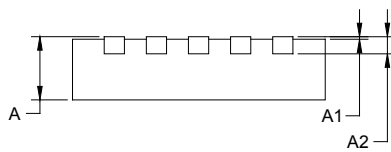

SIDE VIEW

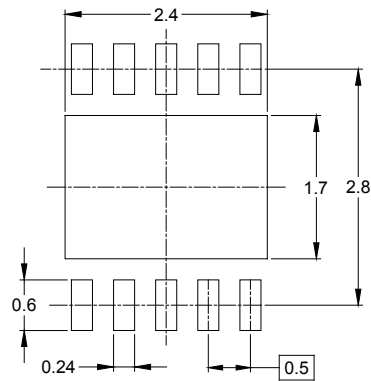

RECOMMENDED LAND PATTERN (Unit: mm)

Symbol	Dimensions In Millimeters		Dimensions In Inches	
	MIN	MAX	MIN	MAX
A	0.700	0.800	0.028	0.031
A1	0.000	0.050	0.000	0.002
A2	0.203 REF		0.008 REF	
D	2.900	3.100	0.114	0.122
D1	2.300	2.600	0.091	0.103
E	2.900	3.100	0.114	0.122
E1	1.500	1.800	0.059	0.071
k	0.200 MIN		0.008 MIN	
b	0.180	0.300	0.007	0.012
e	0.500 TYP		0.020 TYP	
L	0.300	0.500	0.012	0.020

TAPE AND REEL INFORMATION

REEL DIMENSIONS

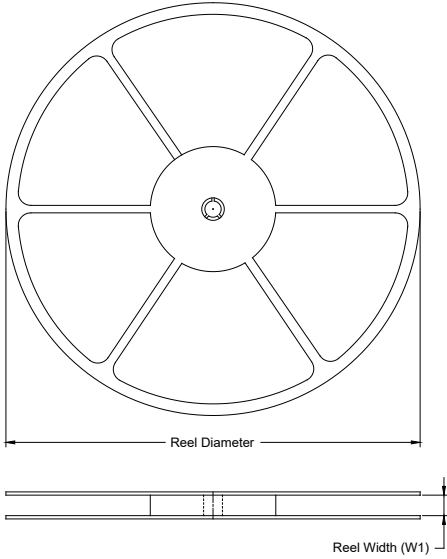

TAPE DIMENSIONS



NOTE: The picture is only for reference. Please make the object as the standard.

KEY PARAMETER LIST OF TAPE AND REEL

Package Type	Reel Diameter	Reel Width W1 (mm)	A0 (mm)	B0 (mm)	K0 (mm)	P0 (mm)	P1 (mm)	P2 (mm)	W (mm)	Pin1 Quadrant
TDFN-3×3-10L	13"	12.4	3.35	3.35	1.13	4.0	8.0	2.0	12.0	Q1

000001

PACKAGE INFORMATION

CARTON BOX DIMENSIONS



NOTE: The picture is only for reference. Please make the object as the standard.

KEY PARAMETER LIST OF CARTON BOX

Reel Type	Length (mm)	Width (mm)	Height (mm)	Pizza/Carton
13"	386	280	370	5

DD0002

单击下面可查看定价，库存，交付和生命周期等信息

[>>SGMICRO\(圣邦微电子\)](#)