



SGM8531/SGM8532/SGM8534 500kHz, 18 μ A, Rail-to-Rail I/O, CMOS Operational Amplifiers

GENERAL DESCRIPTION

The SGM8531 (single), SGM8532 (dual) and SGM8534 (quad) are low cost, voltage feedback amplifiers. These devices can operate from 2.1V to 5.5V single supply, while consuming only 18 μ A quiescent current per amplifier. They provide rail-to-rail input with a wide input common mode voltage range and rail-to-rail output voltage swing. This feature makes SGM8531/2/4 appropriate for buffering ASIC.

The SGM8531/2/4 offer a gain-bandwidth product of 500kHz and an ultra-low input bias current of 0.5pA. They are well suited for piezoelectric sensors, integrators and photodiode amplifiers.

The SGM8531/2/4 are designed into a wide range of applications, such as battery-powered instrumentation, safety monitoring, portable systems, and transducer interface circuits in low power systems.

The SGM8531 is available in Green SOT-23-5 and SOIC-8 packages. The SGM8532 is available in Green SOIC-8 and MSOP-8 packages. The SGM8534 is available in Green SOIC-14 and TSSOP-14 packages. They are specified over the extended -40 $^{\circ}$ C to +125 $^{\circ}$ C temperature range.

FEATURES

- **Low Cost**
- **Input Offset Voltage: 3.5mV (MAX)**
- **Very Low Input Bias Current: 0.5pA**
- **Unity-Gain Stable**
- **Gain-Bandwidth Product: 500kHz**
- **Rail-to-Rail Input and Output**
- **Supply Voltage Range: 2.1V to 5.5V**
- **Input Voltage Range:**
-0.1V to 5.6V with $V_s = 5.5V$
- **Low Supply Current: 18 μ A/Amplifier**
- **-40 $^{\circ}$ C to +125 $^{\circ}$ C Operating Temperature Range**
- **Small Packaging:**
SGM8531 Available in Green SOIC-8 and SOT-23-5 Packages
SGM8532 Available in Green SOIC-8 and MSOP-8 Packages
SGM8534 Available in Green SOIC-14 and TSSOP-14 Packages

APPLICATIONS

ASIC Input or Output Amplifiers
Piezoelectric Transducer Amplifiers
Battery-Powered Equipment
Portable Systems
Sensor Interfaces
Medical Instrumentation
Mobile Communications
Audio Outputs
Smoke Detectors
Mobile Telephones
Notebook PCs
PCMCIA Cards

PACKAGE/ORDERING INFORMATION

MODEL	PACKAGE DESCRIPTION	SPECIFIED TEMPERATURE RANGE	ORDERING NUMBER	PACKAGE MARKING	PACKING OPTION
SGM8531	SOT-23-5	-40°C to +125°C	SGM8531XN5/TR	8531	Tape and Reel, 3000
	SOIC-8	-40°C to +125°C	SGM8531XS/TR	SGM8531XS XXXXX	Tape and Reel, 2500
SGM8532	SOIC-8	-40°C to +125°C	SGM8532XS/TR	SGM8532XS XXXXX	Tape and Reel, 2500
	MSOP-8	-40°C to +125°C	SGM8532XMS/TR	SGM8532 XMS XXXXX	Tape and Reel, 3000
SGM8534	SOIC-14	-40°C to +125°C	SGM8534XS14/TR	SGM8534XS14 XXXXX	Tape and Reel, 2500
	TSSOP-14	-40°C to +125°C	SGM8534XTS14/TR	SGM8534 XTS14 XXXXX	Tape and Reel, 3000

MARKING INFORMATION

NOTE: XXXXX = Date Code and Vendor Code.

XXXXX

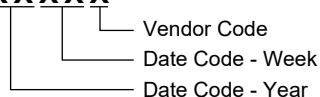

Green (RoHS & HSF): SG Micro Corp defines "Green" to mean Pb-Free (RoHS compatible) and free of halogen substances. If you have additional comments or questions, please contact your SGMICRO representative directly.

ABSOLUTE MAXIMUM RATINGS

- Supply Voltage, +V_S to -V_S.....6V
- Input Common Mode Voltage Range
..... (-V_S) - 0.3V to (+V_S) + 0.3V
- Package Thermal Resistance @ T_A = +25°C
- SOT-23-5, θ_{JA} 190°C/W
- SOIC-8, θ_{JA} 125°C/W
- MSOP-8, θ_{JA} 216°C/W
- Junction Temperature+150°C
- Storage Temperature Range..... -65°C to +150°C
- Lead Temperature (Soldering, 10s)+260°C
- ESD Susceptibility
- HBM.....4000V
- MM.....400V

RECOMMENDED OPERATING CONDITIONS

- Operating Temperature Range -40°C to +125°C

OVERSTRESS CAUTION

Stresses beyond those listed in Absolute Maximum Ratings may cause permanent damage to the device. Exposure to absolute maximum rating conditions for extended periods may affect reliability. Functional operation of the device at any conditions beyond those indicated in the Recommended Operating Conditions section is not implied.

ESD SENSITIVITY CAUTION

This integrated circuit can be damaged if ESD protections are not considered carefully. SGMICRO recommends that all integrated circuits be handled with appropriate precautions. Failure to observe proper handling and installation procedures can cause damage. ESD damage can range from subtle performance degradation to complete device failure. Precision integrated circuits may be more susceptible to damage because even small parametric changes could cause the device not to meet the published specifications.

DISCLAIMER

SG Micro Corp reserves the right to make any change in circuit design, or specifications without prior notice.

PIN CONFIGURATIONS

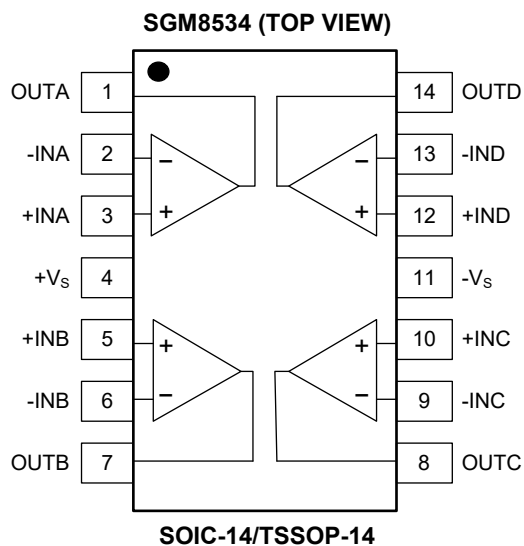
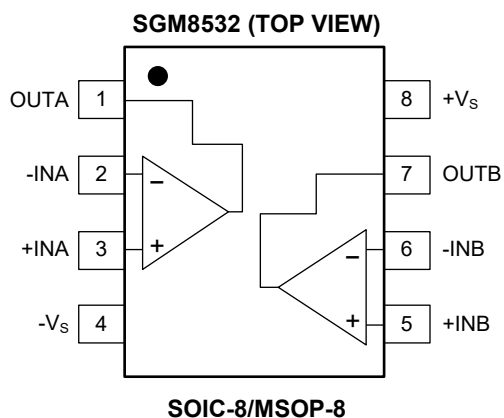
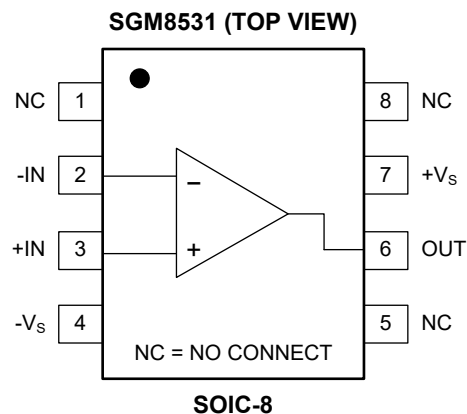
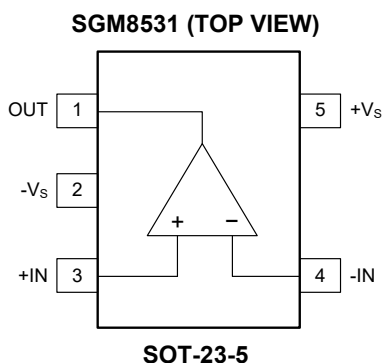

ELECTRICAL CHARACTERISTICS

(At $V_S = 5V$, $R_L = 200k\Omega$ connected to $V_S/2$ and $V_{OUT} = V_S/2$, unless otherwise noted.)

PARAMETER	SYMBOL	CONDITIONS	SGM8531/2/4					
			TYP	MIN/MAX OVER TEMPERATURE			UNITS	MIN/MAX
			+25°C	+25°C	-40°C to +125°C			
Input Characteristics								
Input Offset Voltage	V_{OS}	$V_{CM} = V_S/2$	0.8	3.5	5.4	mV	MAX	
Input Bias Current	I_B		0.5			pA	TYP	
Input Offset Current	I_{OS}		0.5			pA	TYP	
Input Common Mode Voltage Range	V_{CM}	$V_S = 5.5V$	-0.1 to 5.6			V	TYP	
Common Mode Rejection Ratio	CMRR	$V_S = 5.5V, V_{CM} = -0.1V$ to 4V	88	71	68	dB	MIN	
		$V_S = 5.5V, V_{CM} = -0.1V$ to 5.6V	75	60	57			
Open-Loop Voltage Gain	A_{OL}	$R_L = 5k\Omega, V_{OUT} = 0.1V$ to 4.9V	104	86	81	dB	MIN	
		$R_L = 100k\Omega, V_{OUT} = 0.035V$ to 4.965V	110	90	86			
Input Offset Voltage Drift	$\Delta V_{OS}/\Delta T$		1.7			$\mu V/^\circ C$	TYP	
Output Characteristics								
Output Voltage Swing	V_{OH}	$R_L = 100k\Omega$	4.997	4.980	4.970	V	MIN	
	V_{OL}	$R_L = 100k\Omega$	3	20	30	mV	MAX	
	V_{OH}	$R_L = 10k\Omega$	4.994	4.970	4.960	V	MIN	
	V_{OL}	$R_L = 10k\Omega$	6	30	40	mV	MAX	
Output Current	I_{SOURCE}	$R_L = 10\Omega$ to $V_S/2$	85	60	45	mA	MIN	
	I_{SINK}		76	60	45			
Power Supply								
Operating Voltage Range				2.1	2.5	V	MIN	
				5.5	5.5	V	MAX	
Power Supply Rejection Ratio	PSRR	$V_S = 2.5V$ to 5.5V, $V_{CM} = 0.5V$	85	70	66	dB	MIN	
Quiescent Current/Amplifier	I_Q		18	33	39	μA	MAX	
Dynamic Performance ($C_L = 100pF$)								
Gain-Bandwidth Product	GBP		500			kHz	TYP	
Slew Rate	SR	$G = +1, 2V$ Output Step	0.2			$V/\mu s$	TYP	
Settling Time to 0.1%	t_s	$G = +1, 2V$ Output Step	18			μs	TYP	
Overload Recovery Time		$V_{IN} \cdot G = V_S$	16			μs	TYP	
Noise Performance								
Input Voltage Noise Density	e_n	$f = 1kHz$	33			nV/\sqrt{Hz}	TYP	
		$f = 10kHz$	20			nV/\sqrt{Hz}	TYP	

TYPICAL PERFORMANCE CHARACTERISTICS

At $T_A = +25^\circ\text{C}$, $V_S = 5\text{V}$ and $R_L = 200\text{k}\Omega$ connected to $V_S/2$, unless otherwise noted.

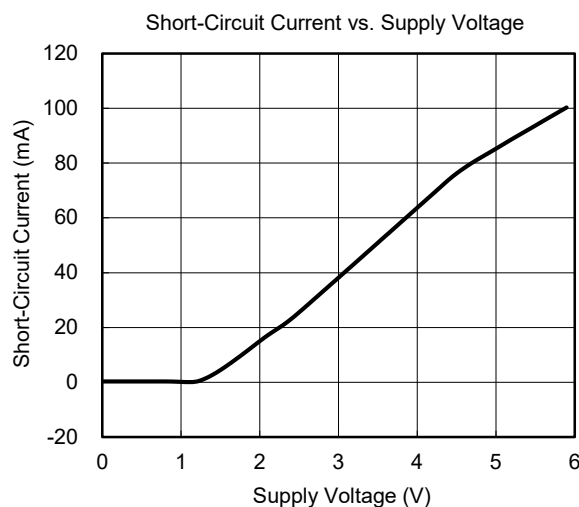
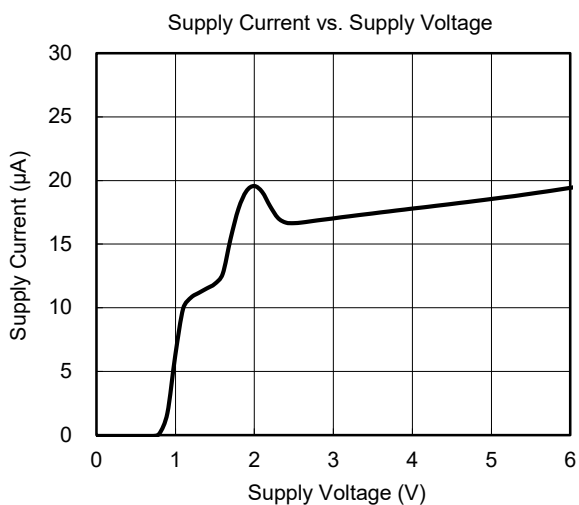
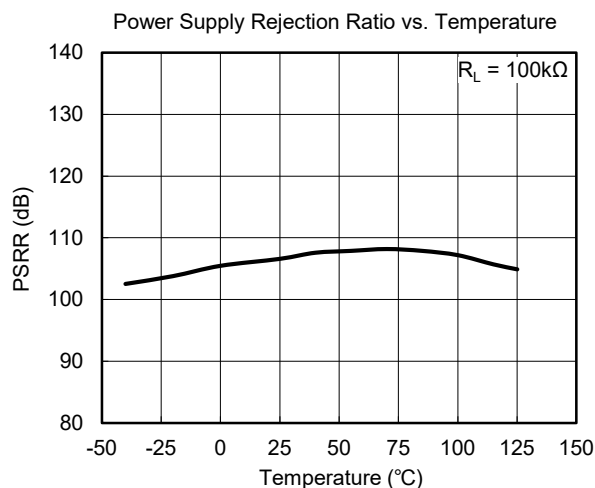
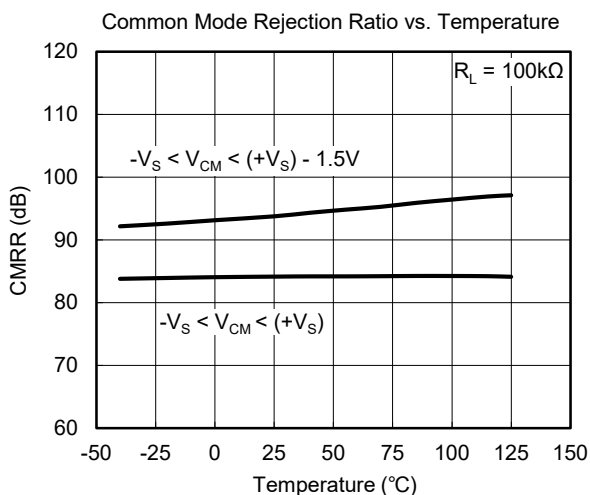
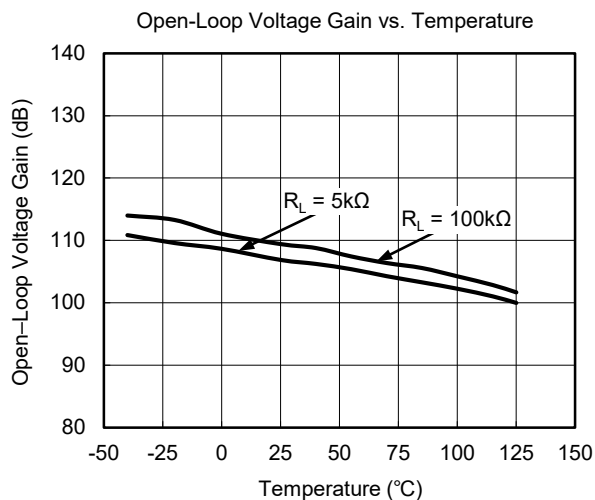
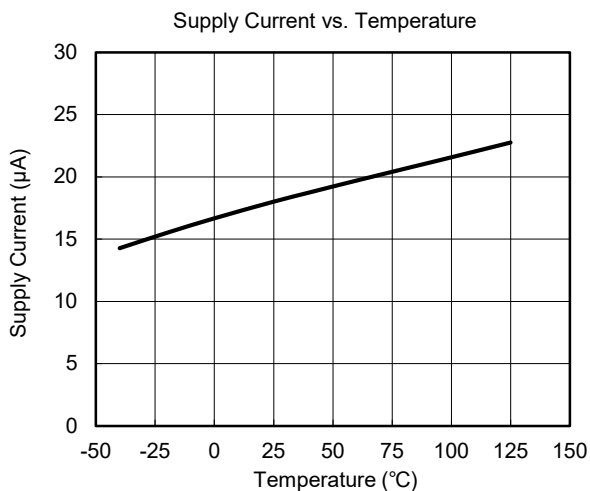

TYPICAL PERFORMANCE CHARACTERISTICS (continued)

At $T_A = +25^\circ\text{C}$, $V_S = 5\text{V}$ and $R_L = 200\text{k}\Omega$ connected to $V_S/2$, unless otherwise noted.

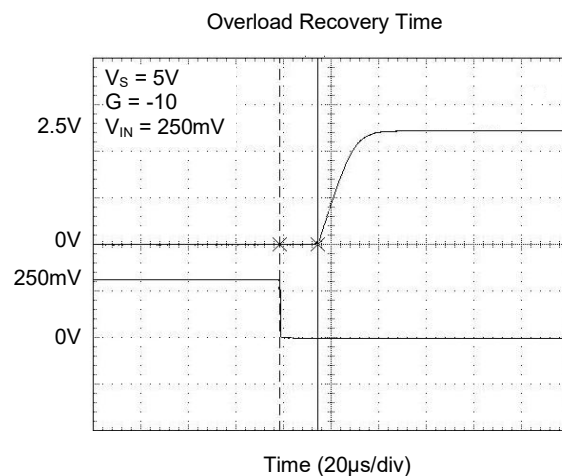
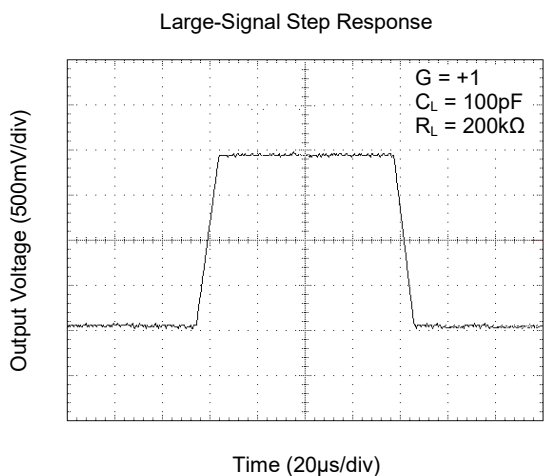
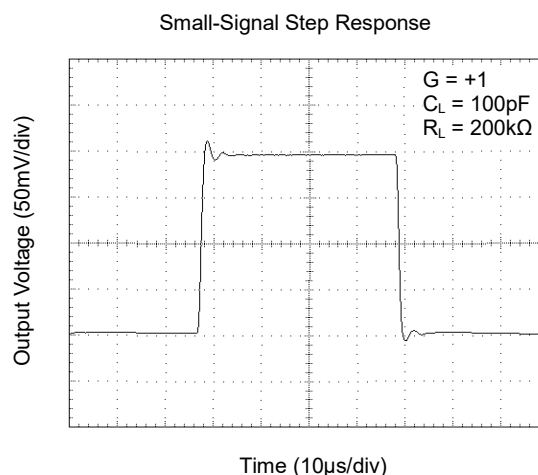
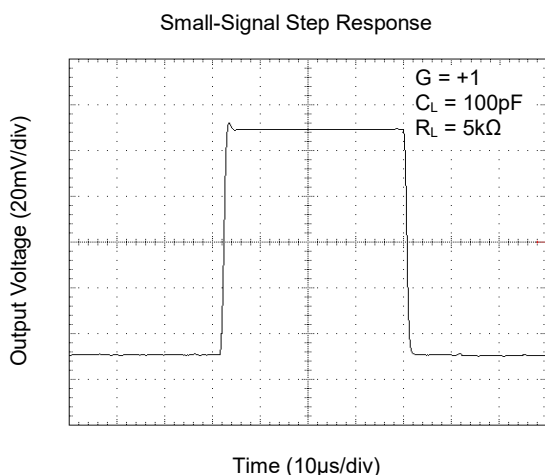
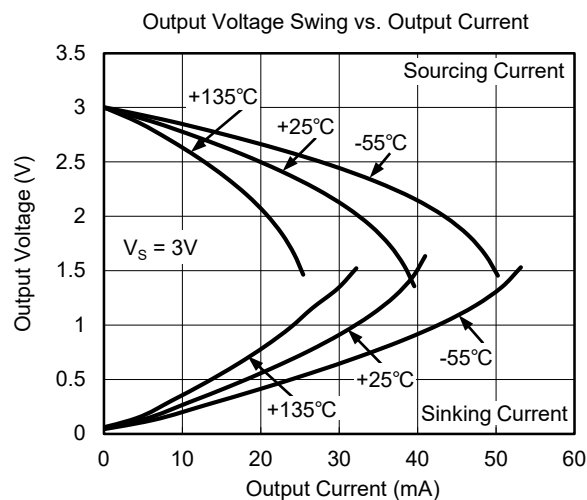
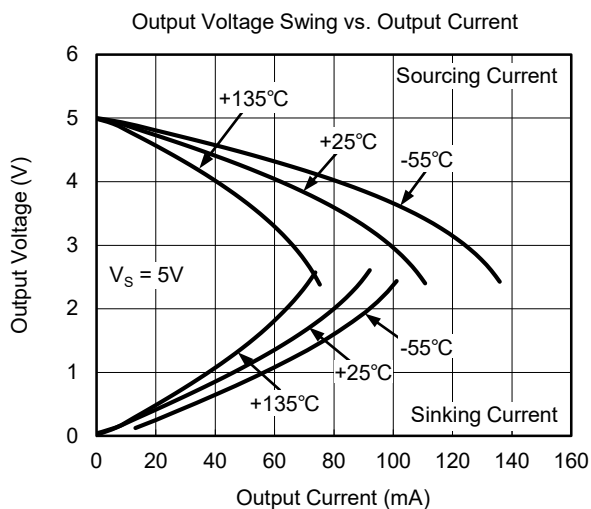

TYPICAL PERFORMANCE CHARACTERISTICS (continued)

At $T_A = +25^\circ\text{C}$, $V_S = 5\text{V}$ and $R_L = 200\text{k}\Omega$ connected to $V_S/2$, unless otherwise noted.

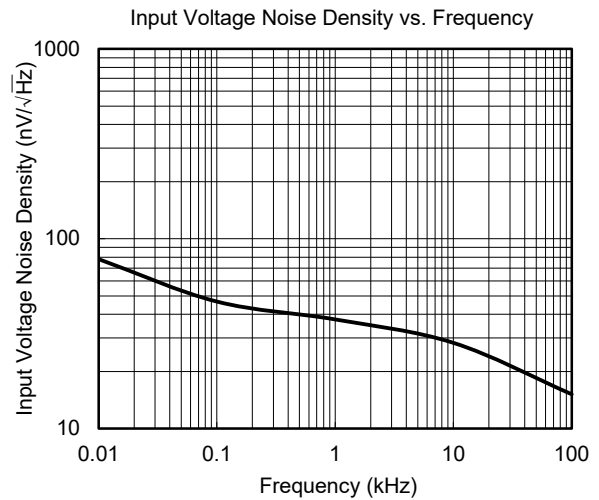
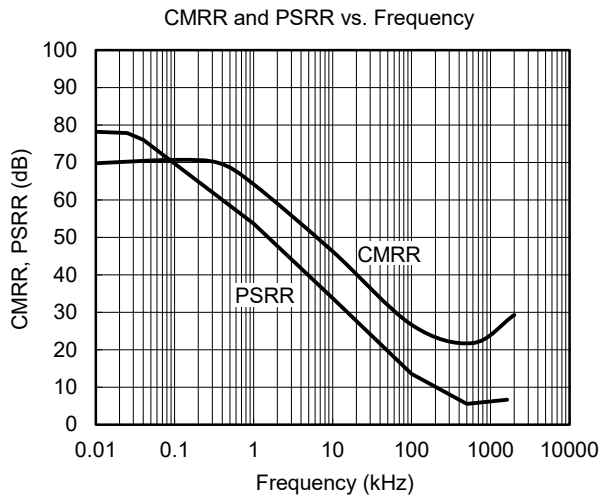
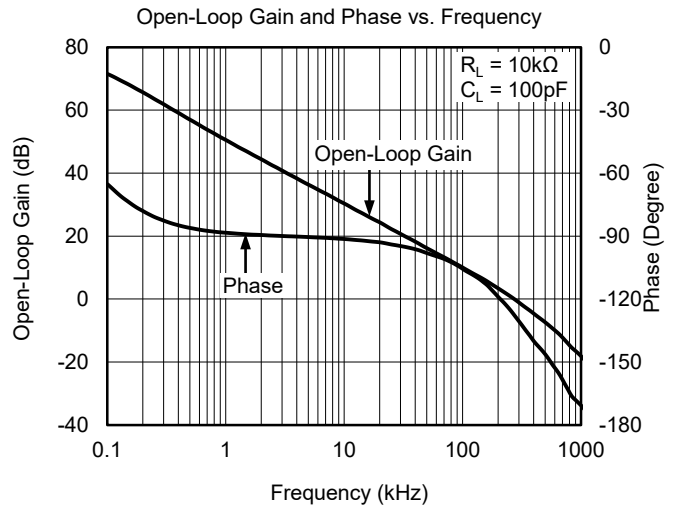
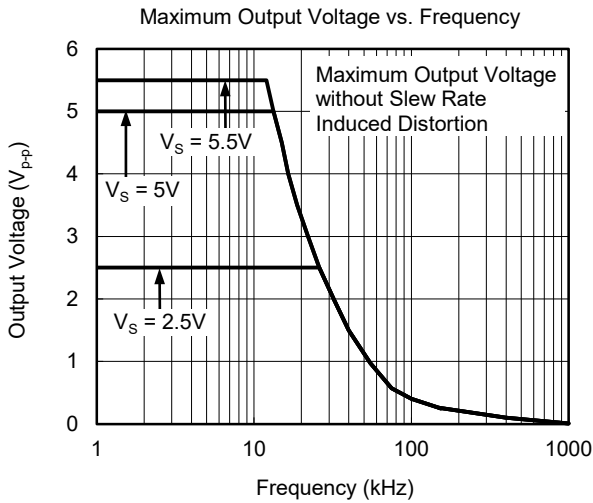
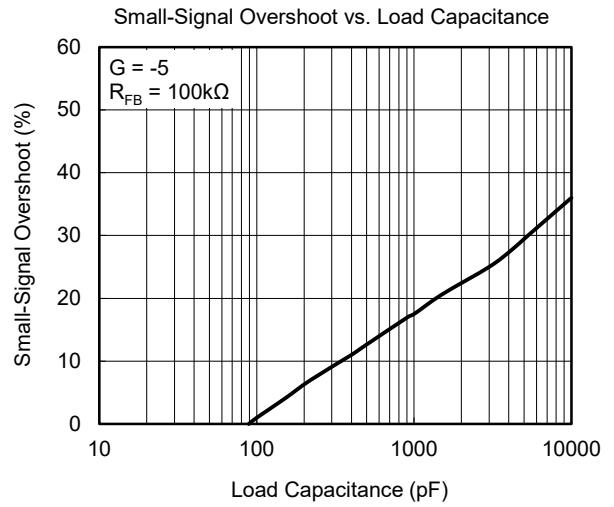
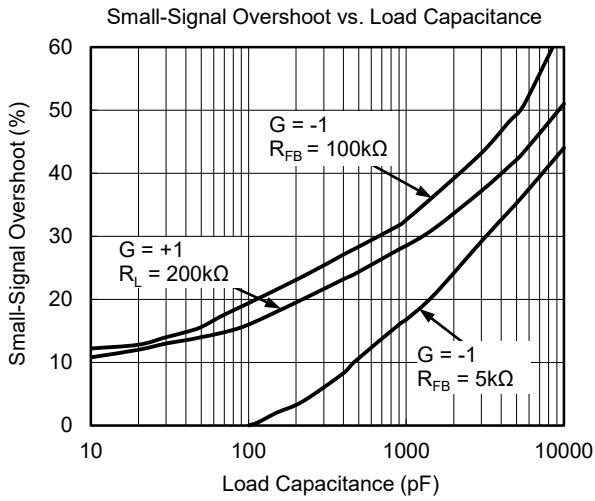

TYPICAL PERFORMANCE CHARACTERISTICS (continued)

At $T_A = +25^\circ\text{C}$, $V_S = 5\text{V}$ and $R_L = 200\text{k}\Omega$ connected to $V_S/2$, unless otherwise noted.

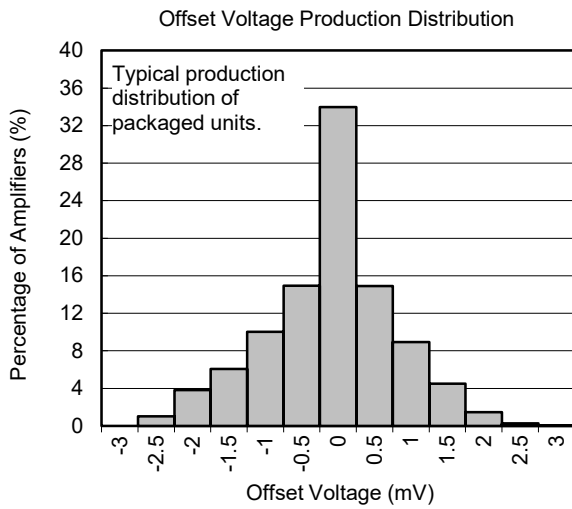

REVISION HISTORY

NOTE: Page numbers for previous revisions may differ from page numbers in the current version.

NOVEMBER 2018 – REV.C.4 to REV.D

Added Open-Loop Gain and Phase vs. Frequency	7
--	---

NOVEMBER 2012 – REV.C.3 to REV.C.4

Added SGM8534	All
---------------------	-----

DECEMBER 2011 – REV.C.2 to REV.C.3

Deleted SGM8534	All
Changed Absolute Maximum Ratings section	2
Changed Electrical Characteristics section	3
Changed Typical Performance Characteristics section	5, 6
Changed Power Supply Bypassing and Layout section	7

MAY 2011 – REV.C.1 to REV.C.2

Changed Caution section	2
-------------------------------	---

FEBRUARY 2009 – REV.C to REV.C.1

Deleted SOIC-16 and TSSOP-16 Packages	All
Changed SOIC-14 Package Option from Tube to Tape and Reel, 2500	2
Changed TSSOP-14 Package Option from Tube to Tape and Reel, 3000	2

PACKAGE OUTLINE DIMENSIONS

SOT-23-5

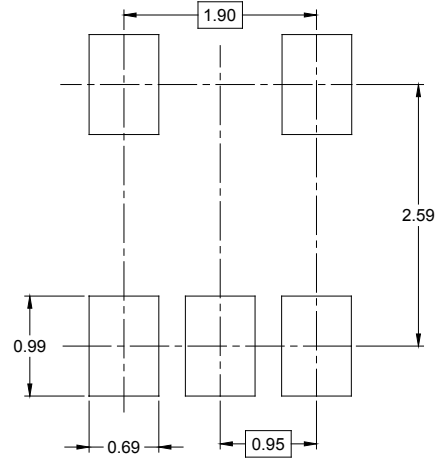

RECOMMENDED LAND PATTERN (Unit: mm)



Symbol	Dimensions In Millimeters		Dimensions In Inches	
	MIN	MAX	MIN	MAX
A	1.050	1.250	0.041	0.049
A1	0.000	0.100	0.000	0.004
A2	1.050	1.150	0.041	0.045
b	0.300	0.500	0.012	0.020
c	0.100	0.200	0.004	0.008
D	2.820	3.020	0.111	0.119
E	1.500	1.700	0.059	0.067
E1	2.650	2.950	0.104	0.116
e	0.950 BSC		0.037 BSC	
e1	1.900 BSC		0.075 BSC	
L	0.300	0.600	0.012	0.024
θ	0°	8°	0°	8°

PACKAGE OUTLINE DIMENSIONS

SOIC-8

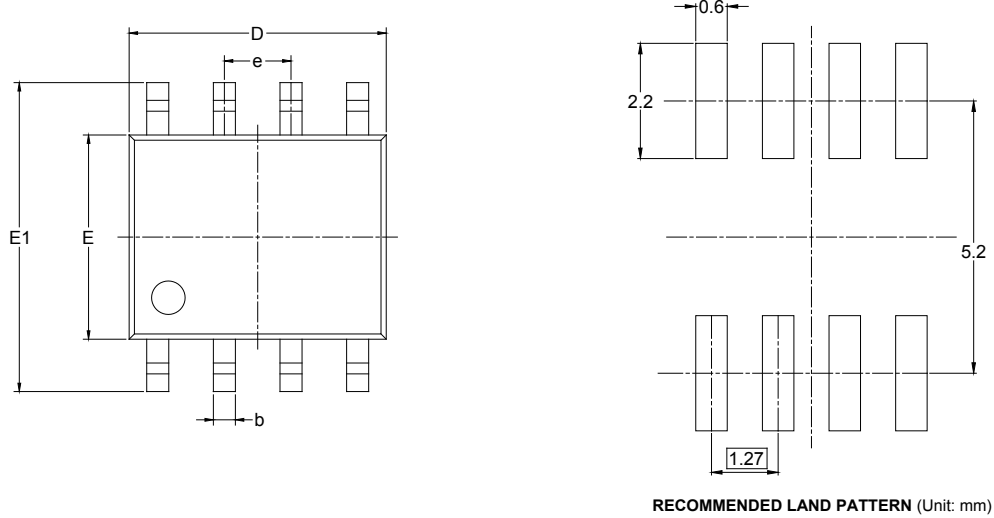

Symbol	Dimensions In Millimeters		Dimensions In Inches	
	MIN	MAX	MIN	MAX
A	1.350	1.750	0.053	0.069
A1	0.100	0.250	0.004	0.010
A2	1.350	1.550	0.053	0.061
b	0.330	0.510	0.013	0.020
c	0.170	0.250	0.006	0.010
D	4.700	5.100	0.185	0.200
E	3.800	4.000	0.150	0.157
E1	5.800	6.200	0.228	0.244
e	1.27 BSC		0.050 BSC	
L	0.400	1.270	0.016	0.050
θ	0°	8°	0°	8°

PACKAGE OUTLINE DIMENSIONS

MSOP-8

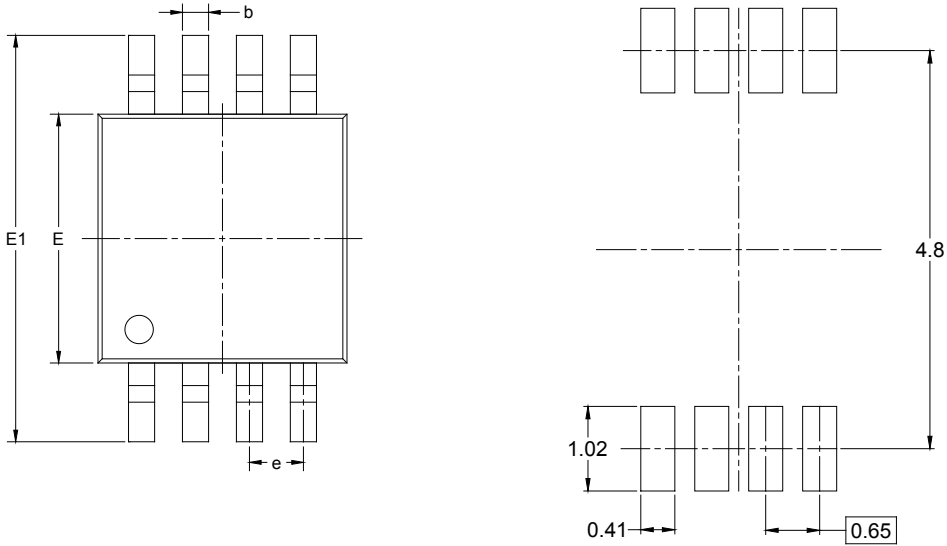

RECOMMENDED LAND PATTERN (Unit: mm)

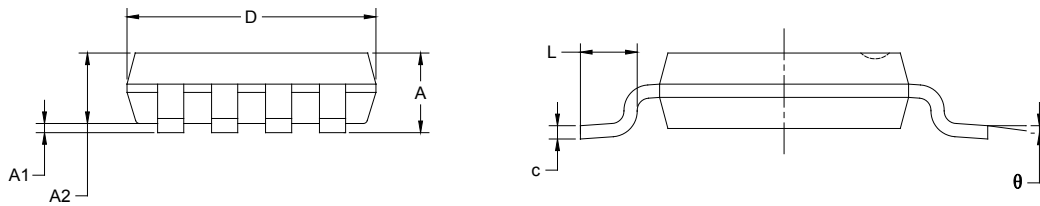

Symbol	Dimensions In Millimeters		Dimensions In Inches	
	MIN	MAX	MIN	MAX
A	0.820	1.100	0.032	0.043
A1	0.020	0.150	0.001	0.006
A2	0.750	0.950	0.030	0.037
b	0.250	0.380	0.010	0.015
c	0.090	0.230	0.004	0.009
D	2.900	3.100	0.114	0.122
E	2.900	3.100	0.114	0.122
E1	4.750	5.050	0.187	0.199
e	0.650 BSC		0.026 BSC	
L	0.400	0.800	0.016	0.031
θ	0°	6°	0°	6°

PACKAGE INFORMATION

PACKAGE OUTLINE DIMENSIONS

SOIC-14

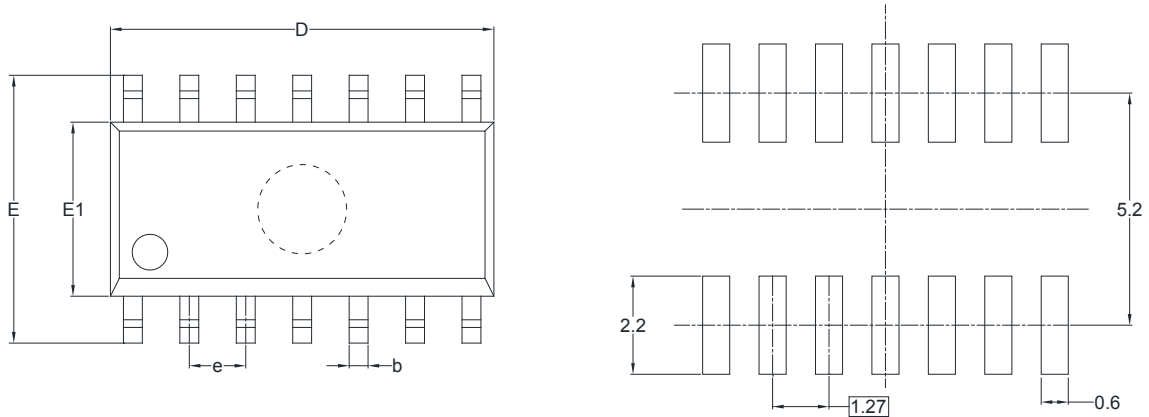

RECOMMENDED LAND PATTERN (Unit: mm)

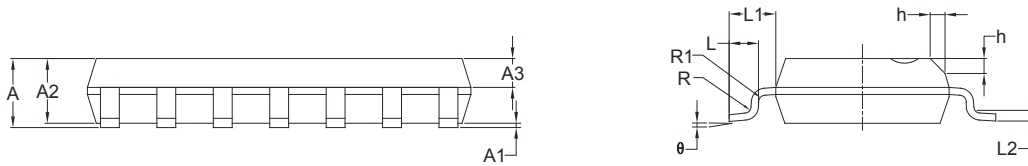

Symbol	Dimensions In Millimeters		Dimensions In Inches	
	MIN	MAX	MIN	MAX
A	1.35	1.75	0.053	0.069
A1	0.10	0.25	0.004	0.010
A2	1.25	1.65	0.049	0.065
A3	0.55	0.75	0.022	0.030
b	0.36	0.49	0.014	0.019
D	8.53	8.73	0.336	0.344
E	5.80	6.20	0.228	0.244
E1	3.80	4.00	0.150	0.157
e	1.27 BSC		0.050 BSC	
L	0.45	0.80	0.018	0.032
L1	1.04 REF		0.040 REF	
L2	0.25 BSC		0.01 BSC	
R	0.07		0.003	
R1	0.07		0.003	
h	0.30	0.50	0.012	0.020
θ	0°	8°	0°	8°

PACKAGE OUTLINE DIMENSIONS

TSSOP-14

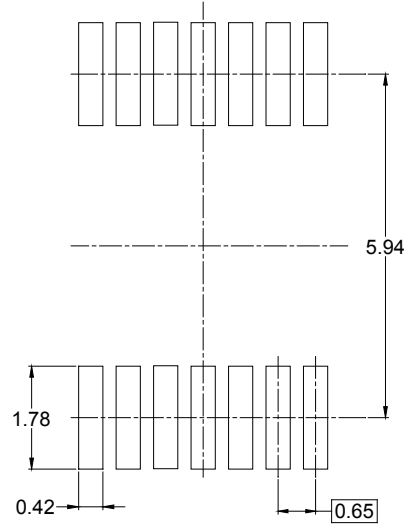
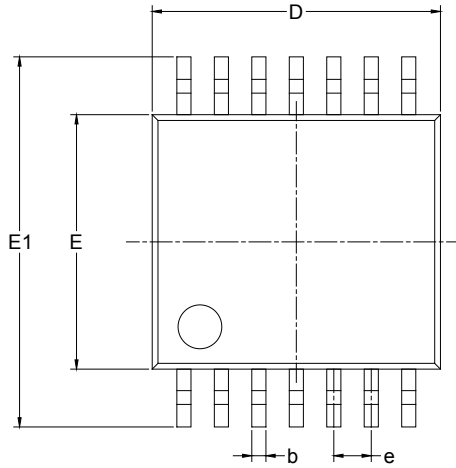

RECOMMENDED LAND PATTERN (Unit: mm)

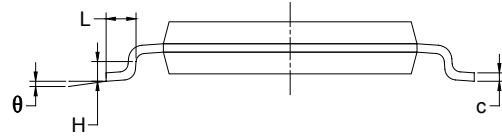
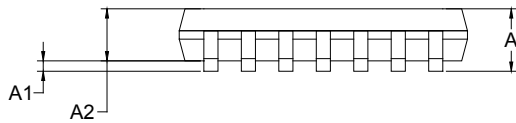

Symbol	Dimensions In Millimeters		Dimensions In Inches	
	MIN	MAX	MIN	MAX
A		1.200		0.047
A1	0.050	0.150	0.002	0.006
A2	0.800	1.050	0.031	0.041
b	0.190	0.300	0.007	0.012
c	0.090	0.200	0.004	0.008
D	4.860	5.100	0.191	0.201
E	4.300	4.500	0.169	0.177
E1	6.250	6.550	0.246	0.258
e	0.650 BSC		0.026 BSC	
L	0.500	0.700	0.02	0.028
H	0.25 TYP		0.01 TYP	
θ	1°	7°	1°	7°

PACKAGE INFORMATION

TAPE AND REEL INFORMATION

REEL DIMENSIONS



TAPE DIMENSIONS

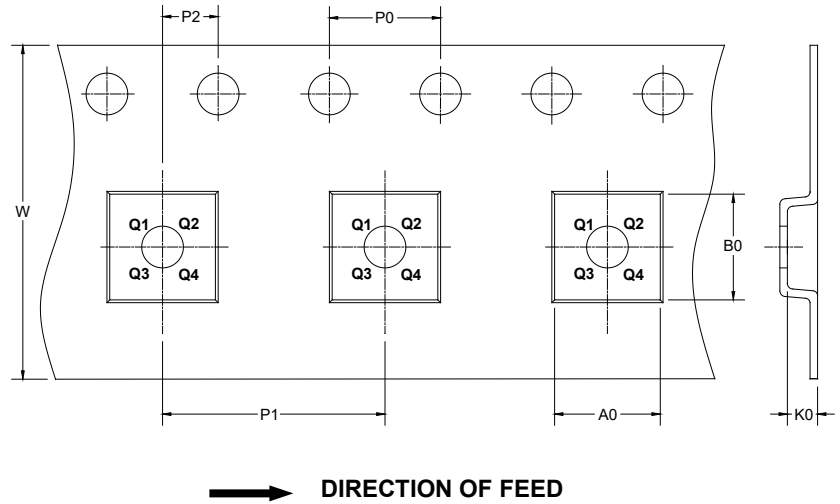

NOTE: The picture is only for reference. Please make the object as the standard.

KEY PARAMETER LIST OF TAPE AND REEL

Package Type	Reel Diameter	Reel Width W1 (mm)	A0 (mm)	B0 (mm)	K0 (mm)	P0 (mm)	P1 (mm)	P2 (mm)	W (mm)	Pin1 Quadrant
SOT-23-5	7"	9.5	3.20	3.20	1.40	4.0	4.0	2.0	8.0	Q3
SOIC-8	13"	12.4	6.40	5.40	2.10	4.0	8.0	2.0	12.0	Q1
MSOP-8	13"	12.4	5.20	3.30	1.50	4.0	8.0	2.0	12.0	Q1
SOIC-14	13"	16.4	6.60	9.30	2.10	4.0	8.0	2.0	16.0	Q1
TSSOP-14	13"	12.4	6.95	5.60	1.20	4.0	8.0	2.0	12.0	Q1

D20001

PACKAGE INFORMATION

CARTON BOX DIMENSIONS



NOTE: The picture is only for reference. Please make the object as the standard.

KEY PARAMETER LIST OF CARTON BOX

Reel Type	Length (mm)	Width (mm)	Height (mm)	Pizza/Carton
7" (Option)	368	227	224	8
7"	442	410	224	18
13"	386	280	370	5

DD0002

单击下面可查看定价，库存，交付和生命周期等信息

[>>SGMICRO\(圣邦微电子\)](#)