

### GENERAL DESCRIPTION

The SGM2045 is an ultra-low noise, low  $V_{IN}$ , high PSRR, high accuracy and low dropout voltage linear regulator. It is capable of supplying 300mA output current with typical dropout voltage of only 80mV. The operating input voltage range is from 1.1V to 5.5V and output voltage range is from 0.6V to 4.2V.

Other features include logic-controlled shutdown mode, short-circuit current limit and thermal shutdown protection. The SGM2045 has automatic discharge function to quickly discharge  $V_{OUT}$  in the disabled status.

The SGM2045 is suitable for application which needs low noise and fast transient response power supply, such as power supply of camera module in smart phone, etc.

The SGM2045 is available in Green XTDFN-1×1-4L and WLCSP-0.64×0.64-4B-A packages. It operates over an operating temperature range of -40°C to +125°C.

### APPLICATIONS

- Portable Electronic Devices
- Smoke Detectors
- IP Cameras
- Wireless LAN Devices
- Battery-Powered Equipment
- Smartphones and Tablets
- Digital Cameras and Audio Devices

### FEATURES

- **Operating Input Voltage Range: 1.1V to 5.5V**
- **Fixed Output Voltage Option: 0.6V to 4.2V**
- **Ultra-Low Noise: 9.5 $\mu$ V<sub>RMS</sub> (TYP)**
- **Ultra-Low Quiescent Current: 15 $\mu$ A (TYP)**
- **Standby Current: 0.03 $\mu$ A (TYP)**
- **High PSRR: 92dB (TYP) at 1kHz**
- **Low Dropout Voltage:**
  - ◆ **100mV (TYP) at 300mA when  $V_{OUT} = 1.8V$  (XTDFN-1×1-4L)**
  - ◆ **80mV (TYP) at 300mA when  $V_{OUT} = 1.8V$  (WLCSP-0.64×0.64-4B-A)**
- **Output Short-Circuit Protection**
- **Thermal Shutdown Protection**
- **Fast Load Transient Response**
- **Stable with 1 $\mu$ F Small Case Size Ceramic Capacitors**
- **-40°C to +125°C Operating Temperature Range**
- **Available in Green XTDFN-1×1-4L and WLCSP-0.64×0.64-4B-A Packages**

### TYPICAL APPLICATION

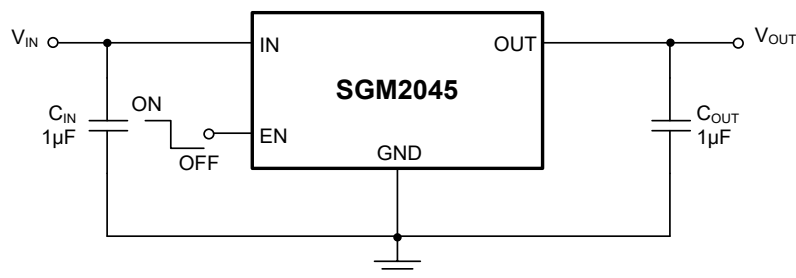

Figure 1. Typical Application Circuit

## PACKAGE/ORDERING INFORMATION

MODEL	PACKAGE DESCRIPTION	SPECIFIED TEMPERATURE RANGE	ORDERING NUMBER	PACKAGE MARKING	PACKING OPTION
SGM2045-0.60	XTDFN-1×1-4L	-40°C to +125°C	SGM2045-0.60XXDH4G/TR	08	Tape and Reel, 10000
SGM2045-0.75	XTDFN-1×1-4L	-40°C to +125°C	SGM2045-0.75XXDH4G/TR	09	Tape and Reel, 10000
SGM2045-0.80	XTDFN-1×1-4L	-40°C to +125°C	SGM2045-0.80XXDH4G/TR	10	Tape and Reel, 10000
SGM2045-0.85	XTDFN-1×1-4L	-40°C to +125°C	SGM2045-0.85XXDH4G/TR	11	Tape and Reel, 10000
SGM2045-1.00	XTDFN-1×1-4L	-40°C to +125°C	SGM2045-1.00XXDH4G/TR	12	Tape and Reel, 10000
SGM2045-1.05	XTDFN-1×1-4L	-40°C to +125°C	SGM2045-1.05XXDH4G/TR	13	Tape and Reel, 10000
SGM2045-1.10	XTDFN-1×1-4L	-40°C to +125°C	SGM2045-1.10XXDH4G/TR	15	Tape and Reel, 10000
SGM2045-1.20	XTDFN-1×1-4L	-40°C to +125°C	SGM2045-1.20XXDH4G/TR	16	Tape and Reel, 10000
SGM2045-1.50	XTDFN-1×1-4L	-40°C to +125°C	SGM2045-1.50XXDH4G/TR	MC	Tape and Reel, 10000
SGM2045-1.80	XTDFN-1×1-4L	-40°C to +125°C	SGM2045-1.80XXDH4G/TR	17	Tape and Reel, 10000
SGM2045-2.50	XTDFN-1×1-4L	-40°C to +125°C	SGM2045-2.50XXDH4G/TR	18	Tape and Reel, 10000
SGM2045-2.80	XTDFN-1×1-4L	-40°C to +125°C	SGM2045-2.80XXDH4G/TR	19	Tape and Reel, 10000
SGM2045-3.00	XTDFN-1×1-4L	-40°C to +125°C	SGM2045-3.00XXDH4G/TR	20	Tape and Reel, 10000
SGM2045-3.30	XTDFN-1×1-4L	-40°C to +125°C	SGM2045-3.30XXDH4G/TR	21	Tape and Reel, 10000
SGM2045-4.20	XTDFN-1×1-4L	-40°C to +125°C	SGM2045-4.20XXDH4G/TR	22	Tape and Reel, 10000
SGM2045-0.60	WLCSP-0.64×0.64-4B-A	-40°C to +125°C	SGM2045-0.60XG/TR	J1	Tape and Reel, 5000
SGM2045-0.80	WLCSP-0.64×0.64-4B-A	-40°C to +125°C	SGM2045-0.80XG/TR	J2	Tape and Reel, 5000
SGM2045-0.85	WLCSP-0.64×0.64-4B-A	-40°C to +125°C	SGM2045-0.85XG/TR	J4	Tape and Reel, 5000
SGM2045-1.00	WLCSP-0.64×0.64-4B-A	-40°C to +125°C	SGM2045-1.00XG/TR	J5	Tape and Reel, 5000
SGM2045-1.05	WLCSP-0.64×0.64-4B-A	-40°C to +125°C	SGM2045-1.05XG/TR	JA	Tape and Reel, 5000
SGM2045-1.10	WLCSP-0.64×0.64-4B-A	-40°C to +125°C	SGM2045-1.10XG/TR	JD	Tape and Reel, 5000
SGM2045-1.20	WLCSP-0.64×0.64-4B-A	-40°C to +125°C	SGM2045-1.20XG/TR	K9	Tape and Reel, 5000
SGM2045-1.75	WLCSP-0.64×0.64-4B-A	-40°C to +125°C	SGM2045-1.75XG/TR	1P	Tape and Reel, 5000
SGM2045-1.80	WLCSP-0.64×0.64-4B-A	-40°C to +125°C	SGM2045-1.80XG/TR	KA	Tape and Reel, 5000
SGM2045-1.825	WLCSP-0.64×0.64-4B-A	-40°C to +125°C	SGM2045-1.825XG/TR	4N	Tape and Reel, 5000
SGM2045-2.50	WLCSP-0.64×0.64-4B-A	-40°C to +125°C	SGM2045-2.50XG/TR	KB	Tape and Reel, 5000
SGM2045-2.80	WLCSP-0.64×0.64-4B-A	-40°C to +125°C	SGM2045-2.80XG/TR	KD	Tape and Reel, 5000
SGM2045-3.00	WLCSP-0.64×0.64-4B-A	-40°C to +125°C	SGM2045-3.00XG/TR	KF	Tape and Reel, 5000
SGM2045-3.30	WLCSP-0.64×0.64-4B-A	-40°C to +125°C	SGM2045-3.30XG/TR	L2	Tape and Reel, 5000
SGM2045-4.20	WLCSP-0.64×0.64-4B-A	-40°C to +125°C	SGM2045-4.20XG/TR	L4	Tape and Reel, 5000

## MARKING INFORMATION

YY

Serial Number

Green (RoHS & HSF): SG Micro Corp defines "Green" to mean Pb-Free (RoHS compatible) and free of halogen substances. If you have additional comments or questions, please contact your SGMICRO representative directly.

**ABSOLUTE MAXIMUM RATINGS**

IN to GND .....	-0.3V to 6V
OUT to GND .....	-0.3V to ( $V_{IN} + 0.3V$ )
EN to GND.....	-0.3V to 6V
Package Thermal Resistance	
XTDFN-1×1-4L, $\theta_{JA}$ .....	242°C/W
XTDFN-1×1-4L, $\theta_{JB}$ .....	107°C/W
XTDFN-1×1-4L, $\theta_{JC}$ .....	238°C/W
WLCSP-0.64×0.64-4B-A, $\theta_{JA}$ .....	285°C/W
WLCSP-0.64×0.64-4B-A, $\theta_{JB}$ .....	50°C/W
WLCSP-0.64×0.64-4B-A, $\theta_{JC}$ .....	116°C/W
Junction Temperature.....	+150°C
Storage Temperature Range .....	-65°C to +150°C
Lead Temperature (Soldering, 10s).....	+260°C
ESD Susceptibility	
HBM.....	8000V
CDM .....	1000V

**RECOMMENDED OPERATING CONDITIONS**

Input Voltage Range .....	1.1V to 5.5V
Enable Input Voltage Range .....	0V to 5.5V
Input Effective Capacitance, $C_{IN}$ .....	0.1µF (MIN)
Output Effective Capacitance, $C_{OUT}$ .....	0.5µF to 200µF
Operating Junction Temperature Range.....	-40°C to +125°C

**OVERSTRESS CAUTION**

Stresses beyond those listed in Absolute Maximum Ratings may cause permanent damage to the device. Exposure to absolute maximum rating conditions for extended periods may affect reliability. Functional operation of the device at any conditions beyond those indicated in the Recommended Operating Conditions section is not implied.

**ESD SENSITIVITY CAUTION**

This integrated circuit can be damaged if ESD protections are not considered carefully. SGMICRO recommends that all integrated circuits be handled with appropriate precautions. Failure to observe proper handling and installation procedures can cause damage. ESD damage can range from subtle performance degradation to complete device failure. Precision integrated circuits may be more susceptible to damage because even small parametric changes could cause the device not to meet the published specifications.

**DISCLAIMER**

SG Micro Corp reserves the right to make any change in circuit design, or specifications without prior notice.

PIN CONFIGURATIONS

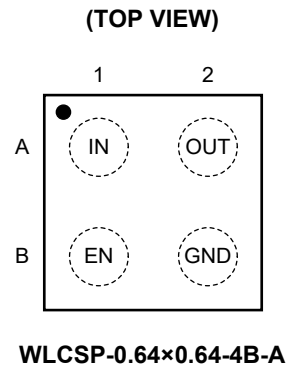
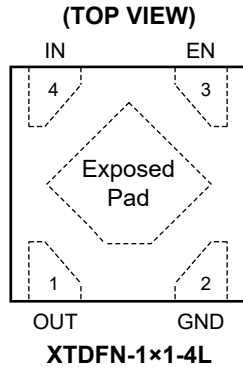

PIN DESCRIPTION

PIN		NAME	FUNCTION
XTDNFN-1x1-4L	WLCSP-0.64x0.64-4B-A		
1	A2	OUT	Regulated Output Voltage Pin. It is recommended to use an output capacitor with effective capacitance in the range of 0.5 $\mu$ F to 200 $\mu$ F. The capacitor should be located very close to this pin.
2	B2	GND	Ground.
3	B1	EN	Enable Pin. Drive EN high to turn on the regulator. Drive EN low to turn off the regulator. The EN pin has an internal 0.03 $\mu$ A pull-down current source which ensures that the device is turned off when the EN pin is floated. This pin must be connected to IN pin if enable functionality is not used.
4	A1	IN	Input Voltage Supply Pin. It is recommended to use a 1 $\mu$ F or larger ceramic capacitor from IN pin to ground.
Exposed Pad	—	—	Exposed Pad. Exposed pad is internally connected to GND. Connect it to a large ground plane to maximize thermal performance.

**ELECTRICAL CHARACTERISTICS**

( $V_{IN} = (V_{OUT(NOM)} + 0.3V)$  or 1.1V (whichever is greater),  $V_{EN} = V_{IN}$ ,  $C_{IN} = C_{OUT} = 1\mu F$ ,  $T_J = -40^\circ C$  to  $+125^\circ C$ , typical values are at  $T_J = +25^\circ C$ , unless otherwise noted.)

PARAMETER	SYMBOL	CONDITIONS		MIN	TYP	MAX	UNITS
Input Voltage Range	$V_{IN}$	$I_{OUT} = 60mA$		1.1		5.5	V
		$I_{OUT} = 100mA$		1.2		5.5	
		$I_{OUT} = 200mA$		1.3		5.5	
		$I_{OUT} = 300mA$		1.4		5.5	
Output Voltage Accuracy	$V_{OUT}$	$V_{IN} = (V_{OUT(NOM)} + 0.3V)$ to 5.5V, $I_{OUT} = 0.1mA$ , $T_J = +25^\circ C$		-1		1	%
		$V_{IN} = (V_{OUT(NOM)} + 0.3V)$ to 5.5V, $I_{OUT} = 0.1mA$ to 300mA		-2.5		2.5	
Line Regulation	$\Delta V_{LNR}$	$V_{IN} = (V_{OUT(NOM)} + 0.3V)$ to 5.5V, $I_{OUT} = 0.1mA$			0.05	2.5	mV
Load Regulation	$\Delta V_{LDR}/V_{OUT}$	$I_{OUT} = 0.1mA$ to 300mA			0.4	10	mV/V
Output Current Limit	$I_{LIMIT}$	$V_{OUT} = 90\% \times V_{OUT(NOM)}$ , $V_{IN} = (V_{OUT(NOM)} + 0.3V)$ or 1.4V	$T_J = -20^\circ C$ to $+125^\circ C$	300	600		mA
			$T_J = -40^\circ C$ to $+125^\circ C$	260	600		
Short-Circuit Current	$I_{SHORT}$	$V_{OUT} = 0V$			380		mA
Quiescent Current	$I_Q$	$I_{OUT} = 0mA$			15	40	$\mu A$
Dropout Voltage <sup>(1)</sup>	$V_{DROP}$	$I_{OUT} = 60mA$	$1.05V \leq V_{OUT(NOM)} < 1.2V$		65	110	mV
			$1.05V \leq V_{OUT(NOM)} < 1.2V$		100	160	
		$I_{OUT} = 100mA$	$1.2V \leq V_{OUT(NOM)} < 1.5V$		65	110	
			$1.05V \leq V_{OUT(NOM)} < 1.2V$		185	260	
		$I_{OUT} = 200mA$	$1.2V \leq V_{OUT(NOM)} < 1.5V$		125	210	
			$1.05V \leq V_{OUT(NOM)} < 1.2V$		260	360	
		$I_{OUT} = 300mA$	$1.2V \leq V_{OUT(NOM)} < 1.5V$		185	300	
			$1.5V \leq V_{OUT(NOM)} < 1.8V$		125	220	
			$1.8V \leq V_{OUT(NOM)} < 2.8V$		100	190	
		$I_{OUT} = 300mA$ , XTDFN-1x1-4L	$2.8V \leq V_{OUT(NOM)} \leq 4.2V$		70	150	
$1.8V \leq V_{OUT(NOM)} < 2.8V$			80	130			
$I_{OUT} = 300mA$ , WLCSP-0.64x0.64-4B-A	$2.8V \leq V_{OUT(NOM)} \leq 4.2V$		50	120			
EN Input Threshold	$V_{IH}$	$V_{IN} = 1.1V$ to 5.5V		0.7			V
	$V_{IL}$					0.3	
EN Pull-Down Current	$I_{EN}$	$V_{EN} = V_{IN} = 5.5V$			0.03	1	$\mu A$
Shutdown Current	$I_{SHDN}$	$V_{EN} = 0V$ , $V_{IN} = 5.5V$			0.03	2	$\mu A$
Turn-On Time	$t_{ON}$	From EN rising from 0V to $V_{IN}$ to 90% $\times V_{OUT(NOM)}$ , no load			100	240	$\mu s$
Power Supply Rejection Ratio	PSRR	$I_{OUT} = 20mA$ , $V_{IN} = V_{OUT(NOM)} + 1V$	$f = 100Hz$		90		dB
			$f = 1kHz$		92		
			$f = 10kHz$		80		
			$f = 100kHz$		55		
Output Voltage Noise	$e_n$	$f = 10Hz$ to 100kHz, $I_{OUT} = 20mA$			9.5		$\mu V_{RMS}$
Output Discharge Resistance	$R_{DIS}$	$V_{EN} = 0V$ , $V_{OUT} = 0.2V$ , $V_{IN} = 3.3V$			60		$\Omega$
Thermal Shutdown Temperature	$T_{SHDN}$				160		$^\circ C$
Thermal Shutdown Hysteresis	$\Delta T_{SHDN}$				20		$^\circ C$

NOTE:

1. Dropout voltage is characterized when  $V_{OUT}$  falls 50mV below  $V_{OUT(NOM)}$ .

TYPICAL PERFORMANCE CHARACTERISTICS

$T_J = +25^\circ\text{C}$ ,  $V_{IN} = (V_{OUT(NOM)} + 0.3\text{V})$  or  $1.1\text{V}$  (whichever is greater),  $V_{EN} = V_{IN}$ ,  $C_{IN} = C_{OUT} = 1\mu\text{F}$ , unless otherwise noted.

Line Transient Response

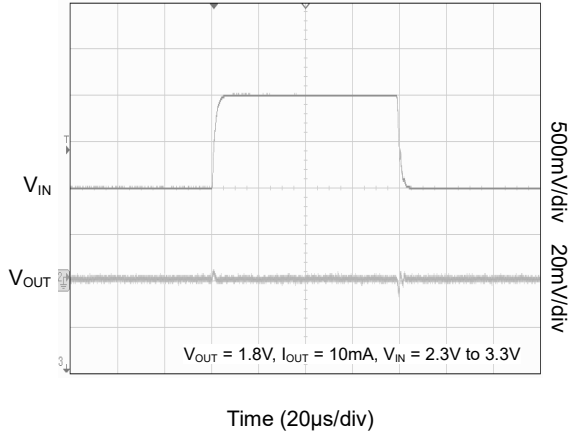

Line Transient Response

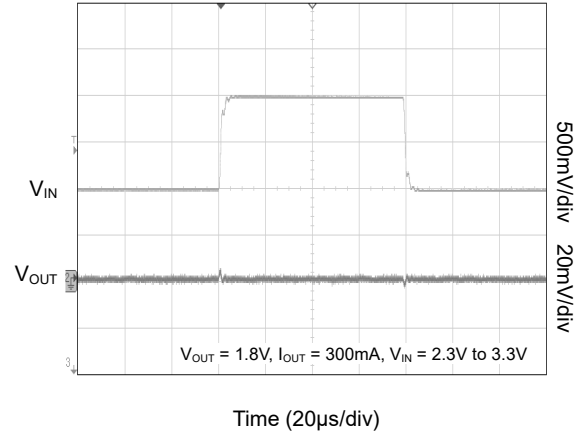

Load Transient Response

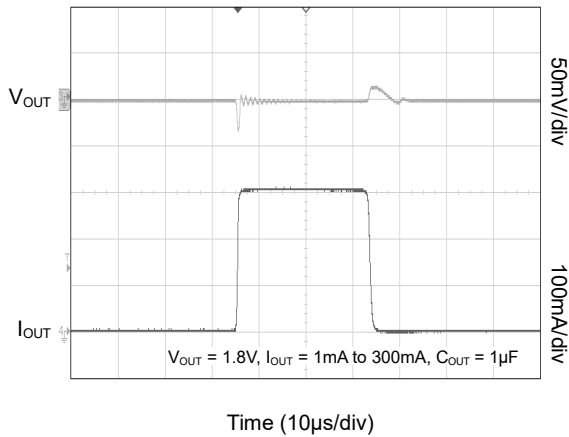

Load Transient Response

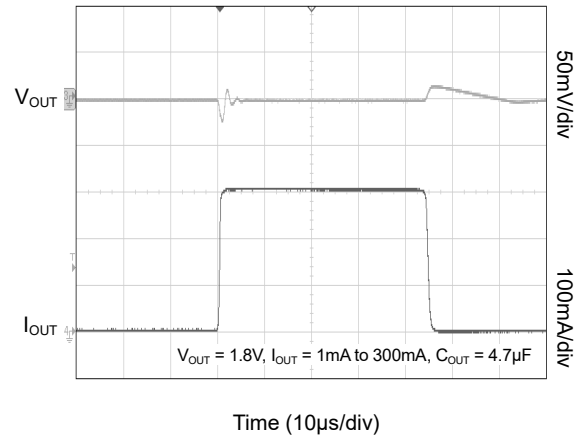

Line Transient Response

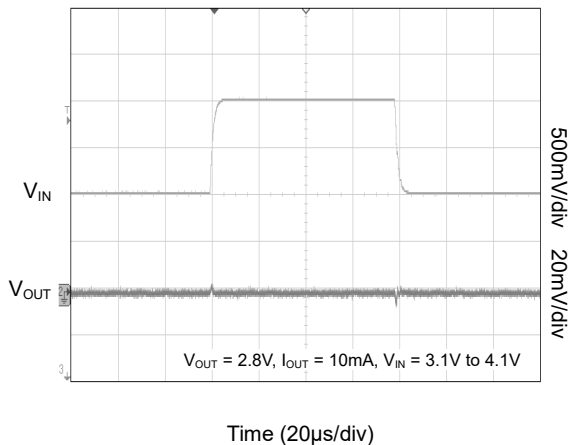

Line Transient Response

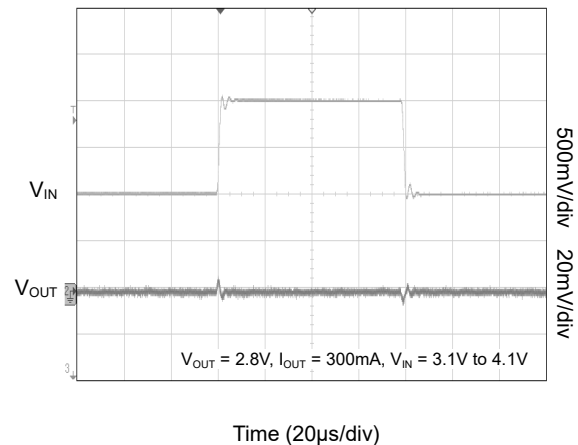

TYPICAL PERFORMANCE CHARACTERISTICS (continued)

$T_J = +25^\circ\text{C}$ ,  $V_{IN} = (V_{OUT(NOM)} + 0.3\text{V})$  or 1.1V (whichever is greater),  $V_{EN} = V_{IN}$ ,  $C_{IN} = C_{OUT} = 1\mu\text{F}$ , unless otherwise noted.

Load Transient Response

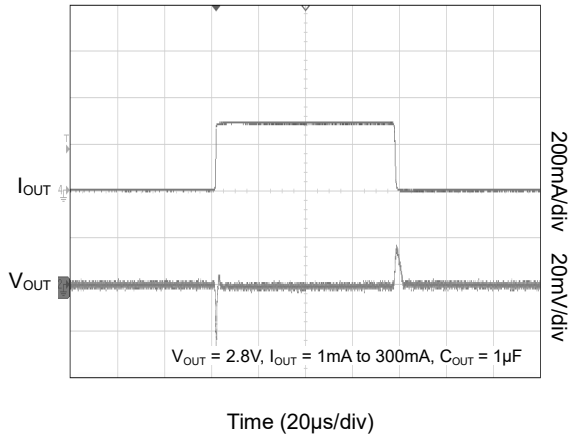

Load Transient Response

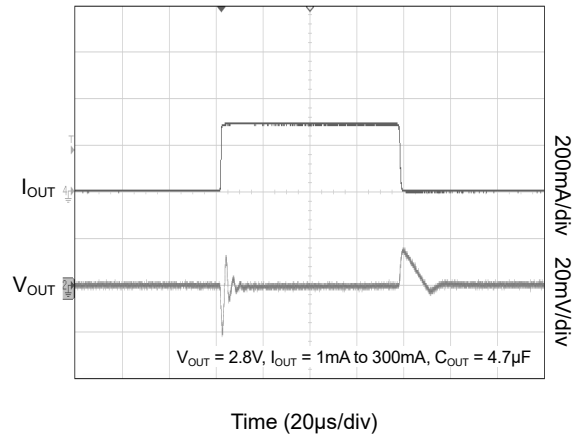

Power Supply Rejection Ratio vs. Frequency

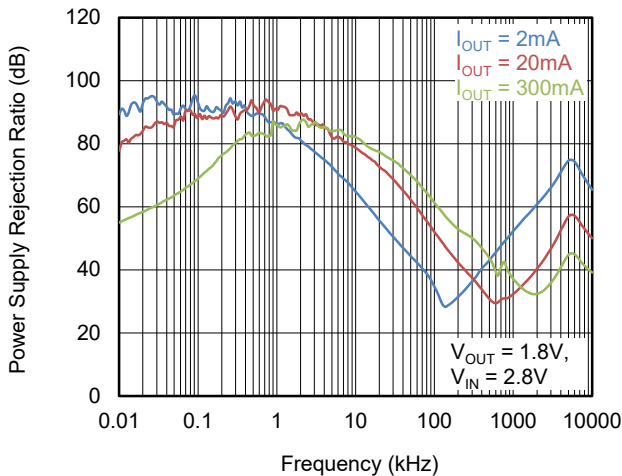

Power Supply Rejection Ratio vs. Frequency

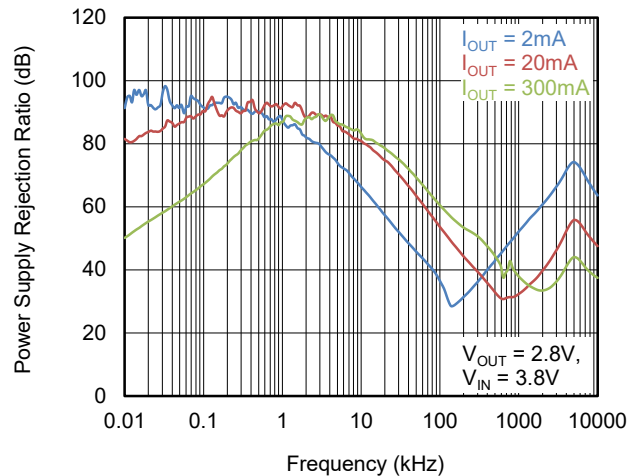

Output Noise Density vs. Frequency

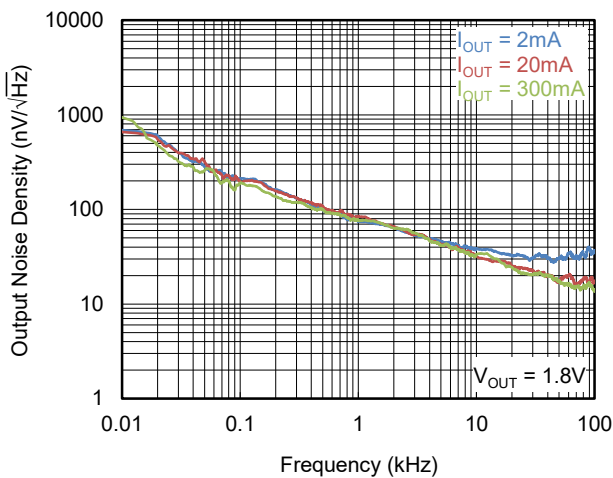

Output Noise Density vs. Frequency

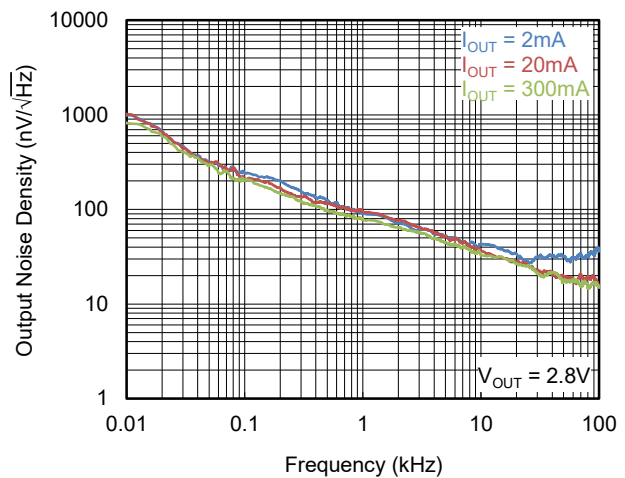

TYPICAL PERFORMANCE CHARACTERISTICS (continued)

$T_J = +25^\circ\text{C}$ ,  $V_{IN} = (V_{OUT(NOM)} + 0.3\text{V})$  or 1.1V (whichever is greater),  $V_{EN} = V_{IN}$ ,  $C_{IN} = C_{OUT} = 1\mu\text{F}$ , unless otherwise noted.

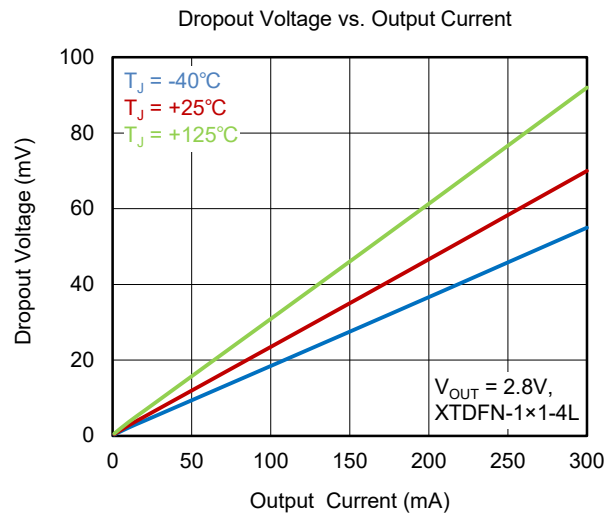
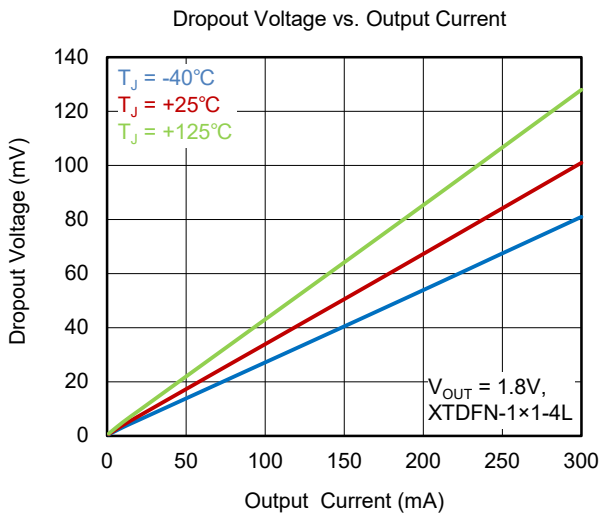
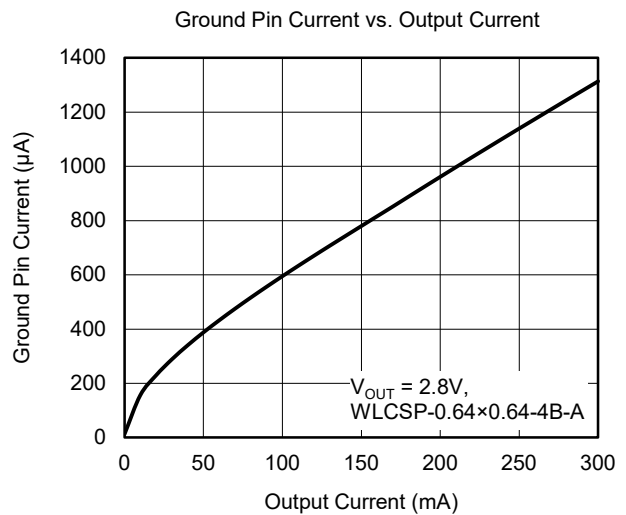
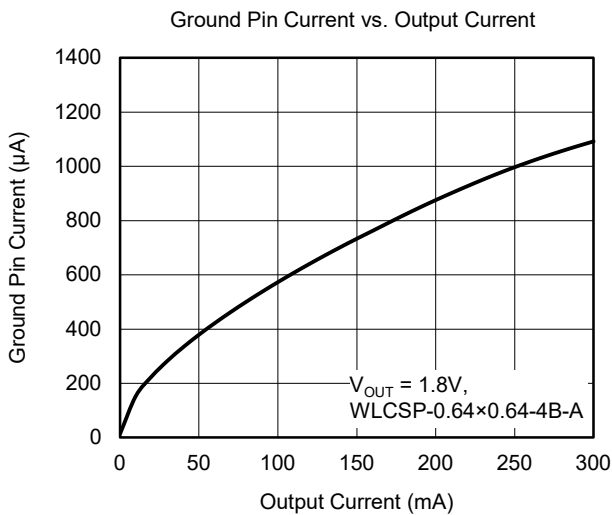
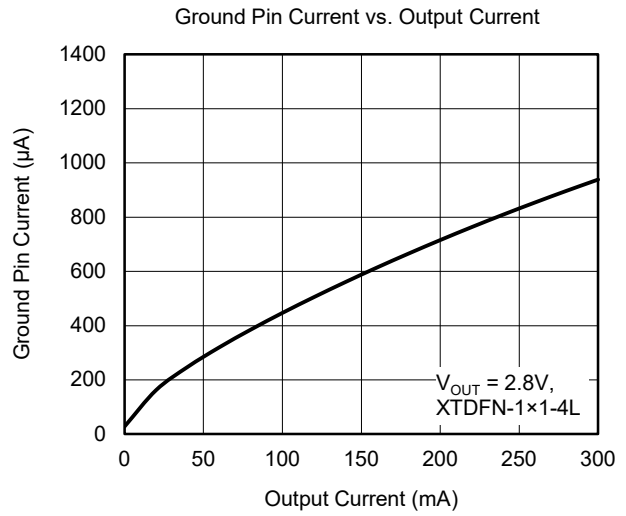
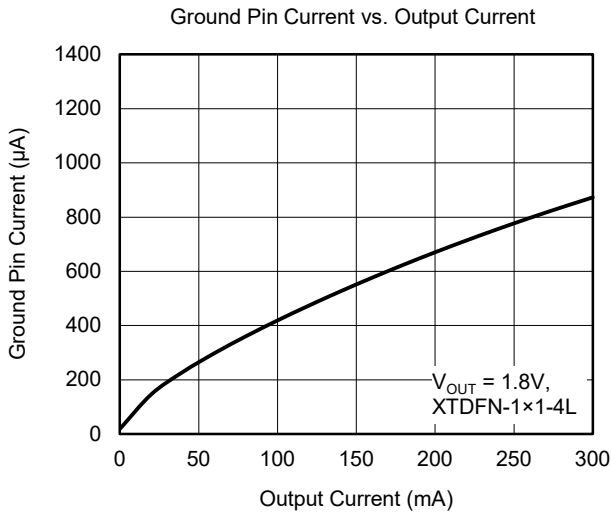



TYPICAL PERFORMANCE CHARACTERISTICS (continued)

$T_J = +25^\circ\text{C}$ ,  $V_{IN} = (V_{OUT(NOM)} + 0.3\text{V})$  or  $1.1\text{V}$  (whichever is greater),  $V_{EN} = V_{IN}$ ,  $C_{IN} = C_{OUT} = 1\mu\text{F}$ , unless otherwise noted.

Dropout Voltage vs. Output Current

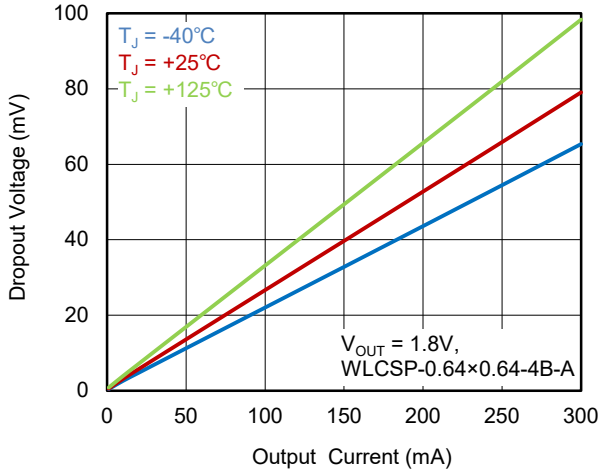

Dropout Voltage vs. Output Current

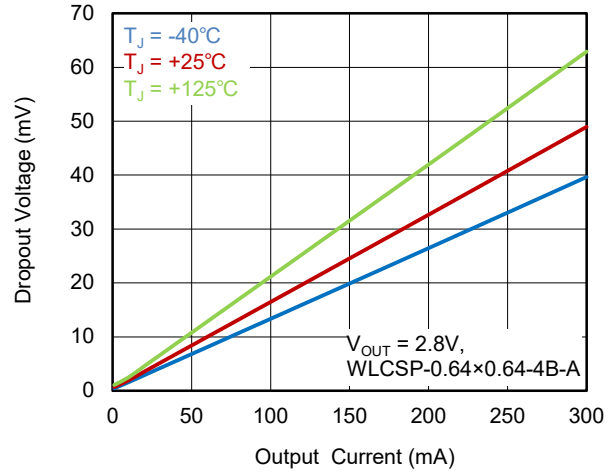

Dropout Voltage vs. Temperature

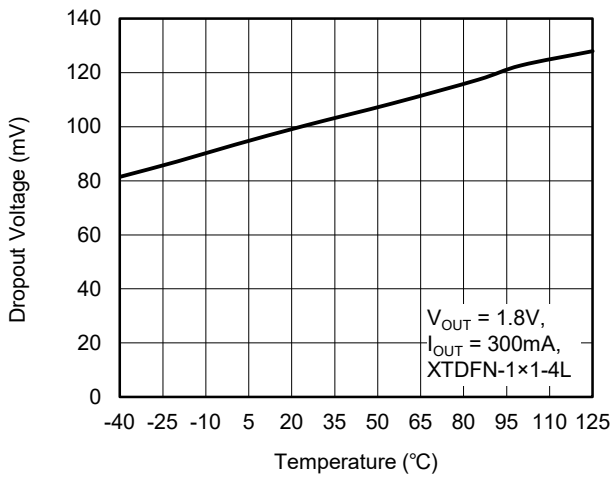

Dropout Voltage vs. Temperature

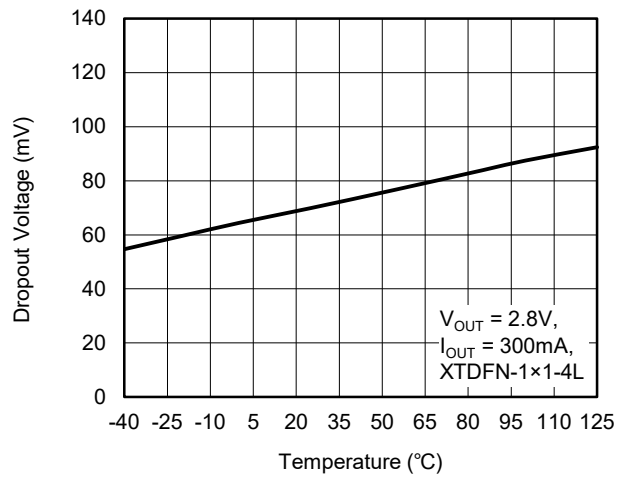

Dropout Voltage vs. Temperature

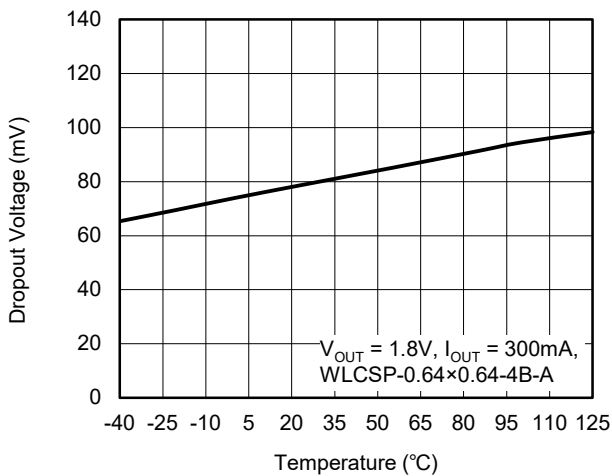

Dropout Voltage vs. Temperature

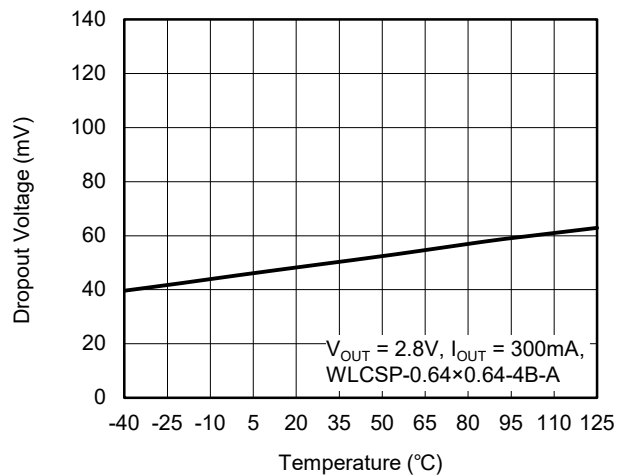

TYPICAL PERFORMANCE CHARACTERISTICS (continued)

$T_J = +25^\circ\text{C}$ ,  $V_{IN} = (V_{OUT(NOM)} + 0.3\text{V})$  or  $1.1\text{V}$  (whichever is greater),  $V_{EN} = V_{IN}$ ,  $C_{IN} = C_{OUT} = 1\mu\text{F}$ , unless otherwise noted.

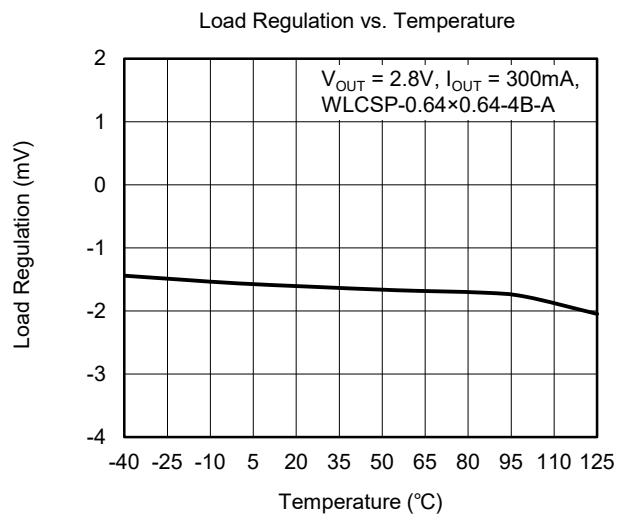
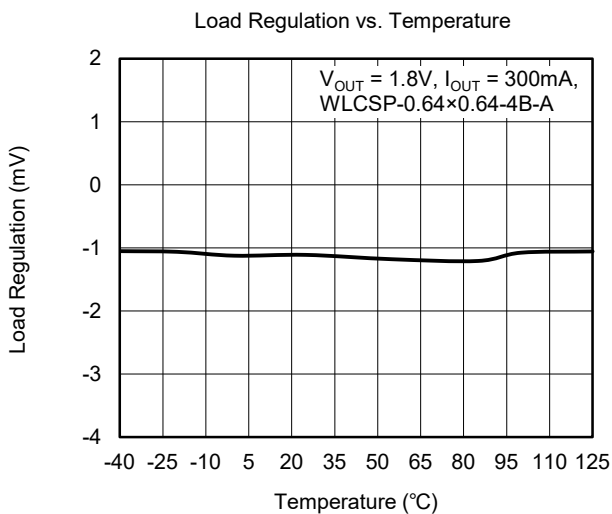
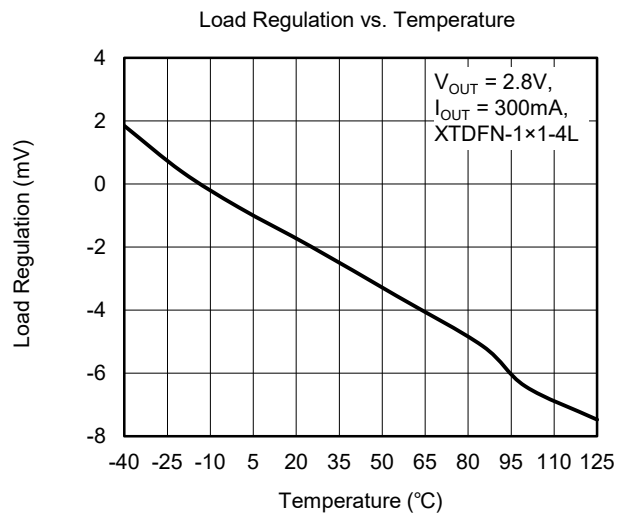
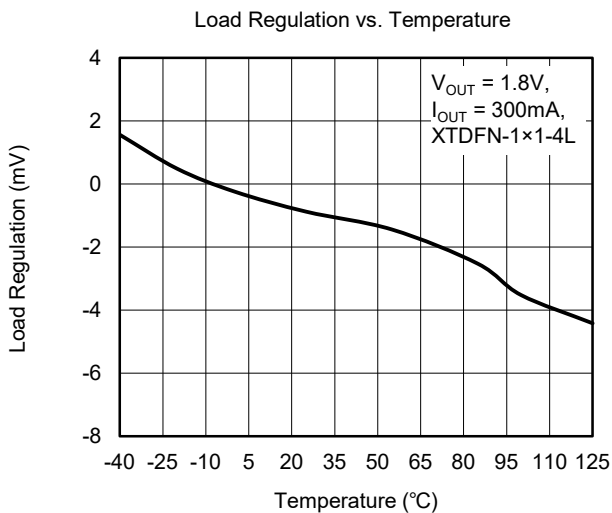
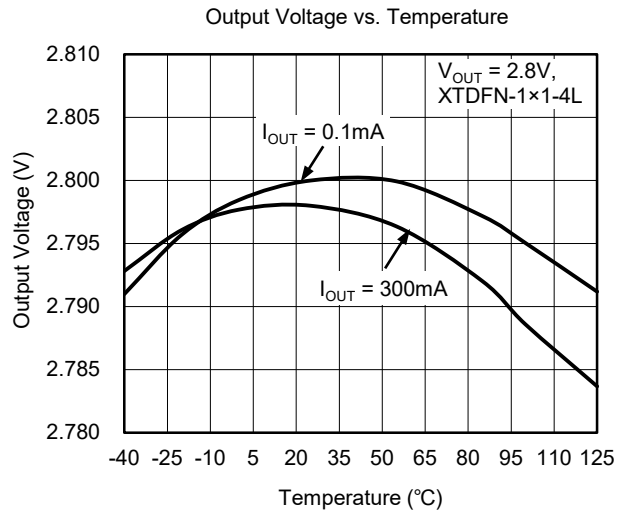
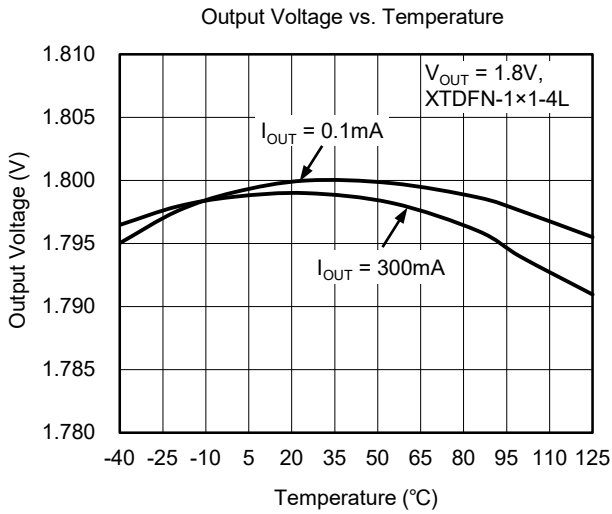

TYPICAL PERFORMANCE CHARACTERISTICS (continued)

$T_J = +25^\circ\text{C}$ ,  $V_{IN} = (V_{OUT(NOM)} + 0.3\text{V})$  or  $1.1\text{V}$  (whichever is greater),  $V_{EN} = V_{IN}$ ,  $C_{IN} = C_{OUT} = 1\mu\text{F}$ , unless otherwise noted.

Enable Turn-On Response

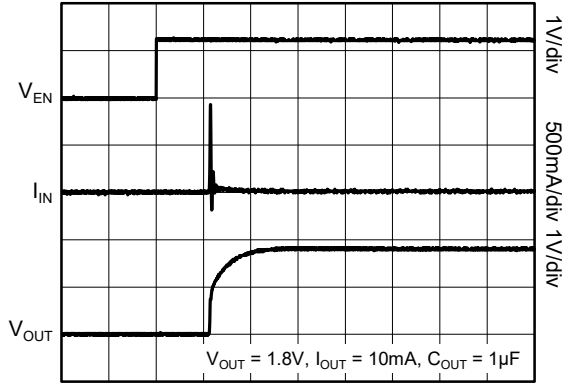

Time (50 $\mu\text{s}/\text{div}$ )

Enable Turn-On Response

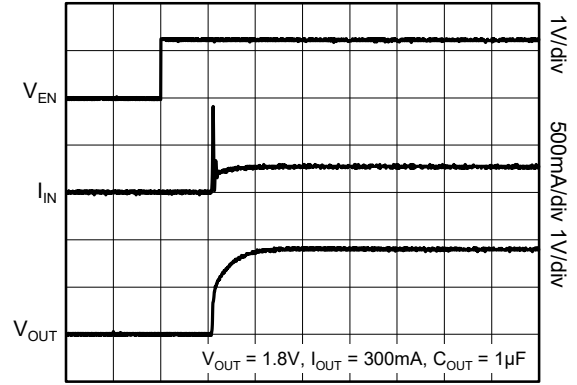

Time (50 $\mu\text{s}/\text{div}$ )

Enable Turn-On Response

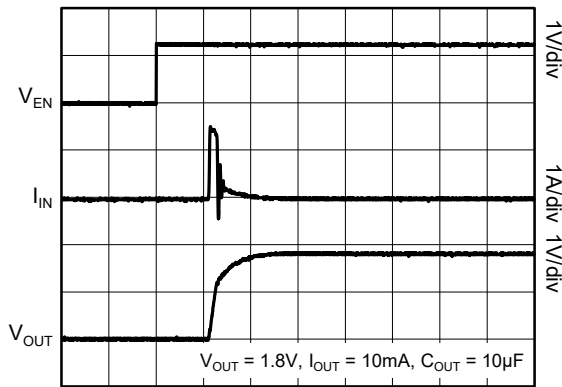

Time (50 $\mu\text{s}/\text{div}$ )

Enable Turn-On Response

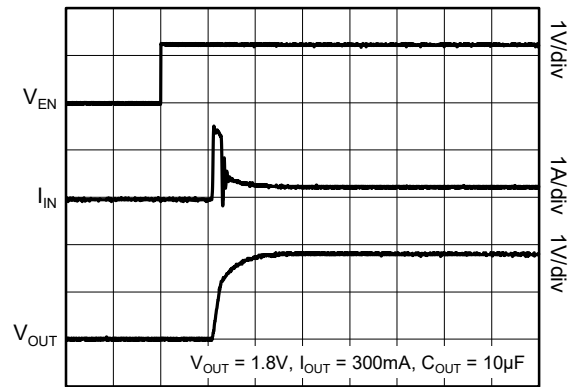

Time (50 $\mu\text{s}/\text{div}$ )

Enable Turn-Off Response

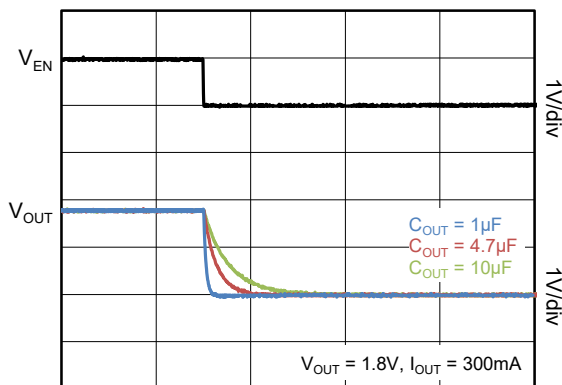

Time (200 $\mu\text{s}/\text{div}$ )

FUNCTIONAL BLOCK DIAGRAM

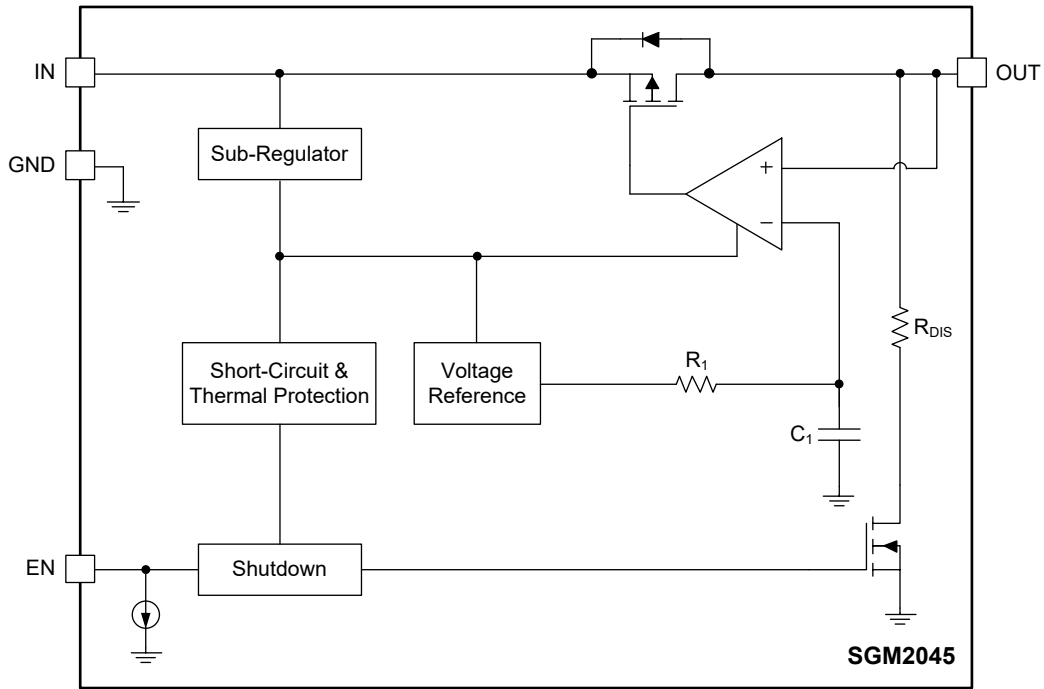

Figure 2. Block Diagram

## APPLICATION INFORMATION

The SGM2045 is a low input voltage, ultra-low noise and low dropout LDO and provides 300mA output current. These features make the device a reliable solution to solve many challenging problems in the generation of clean and accurate power supply. The high performance also makes the SGM2045 useful in a variety of applications. The SGM2045 provides the protection function for output overload, output short-circuit condition and overheating.

The SGM2045 provides an EN pin as an external chip enable control to enable/disable the device. When the regulator is in shutdown state, the shutdown current consumes as low as 0.03 $\mu$ A (TYP).

### Input Capacitor Selection ( $C_{IN}$ )

The input decoupling capacitor is necessary to be connected as close as possible to the IN pin for ensuring the device stability. 0.1 $\mu$ F or greater X7R or X5R ceramic capacitor is selected to get good dynamic performance.

When  $V_{IN}$  is required to provide large current instantaneously, a large effective input capacitor is required. Multiple input capacitors can limit the input tracking inductance. Adding more input capacitors is available to restrict the ringing and to keep it below the device absolute maximum ratings.

### Output Capacitor Selection ( $C_{OUT}$ )

The output decoupling capacitor should be located as close as possible to the OUT pin. 1 $\mu$ F or greater X7R or X5R ceramic capacitor is selected to get good dynamic performance. The minimum effective capacitance of  $C_{OUT}$  that SGM2045 can remain stable is 0.5 $\mu$ F. For ceramic capacitor, temperature, DC bias and package size will change the effective capacitance, so enough margin of  $C_{OUT}$  must be considered in design. Larger capacitance and lower ESR  $C_{OUT}$  will help improve the load transient response and increase the high frequency PSRR.

### Enable Control

The SGM2045 uses the EN pin to enable/disable its device and to deactivate/activate the output automatic discharge function.

When the EN pin voltage is lower than 0.3V, the device is in shutdown state, there is no current flowing from IN to OUT pins. In this state, the automatic discharge

transistor is active to discharge the output voltage through a 60 $\Omega$  (TYP) resistor.

When the EN pin voltage is higher than 0.7V, the device is in active state, the input voltage is regulated to the output voltage and the automatic discharge transistor is turned off.

The EN pin is pulled down by internal 0.03 $\mu$ A (TYP) current source when the EN pin is floated. This current source will ensure the SGM2045 in shutdown state and reduce the power dissipation in system.

### Output Current Limit and Short-Circuit Protection

When overload events happen, the output current is internally limited to 600mA (TYP). When the OUT pin is shorted to ground, the short-circuit protection will limit the output current to 380mA (TYP).

### Thermal Shutdown

The SGM2045 can detect the temperature of die. When the die temperature exceeds the threshold value of thermal shutdown, the SGM2045 will be in shutdown state and it will remain in this state until the die temperature decreases to +140 $^{\circ}$ C.

### Power Dissipation ( $P_D$ )

Thermal protection limits power dissipation in the SGM2045. When power dissipation on pass element ( $P_D = (V_{IN} - V_{OUT}) \times I_{OUT}$ ) is too much that raise the operation junction temperature exceeds +160 $^{\circ}$ C, the OTP circuit starts the thermal shutdown function and turns the pass element off.

Therefore, thermal analysis for the chosen application is important to guarantee reliable performance over all conditions. To guarantee reliable operation, the junction temperature of the SGM2045 must not exceed +125 $^{\circ}$ C.

The maximum allowable power dissipation depends on the thermal resistance of the IC package, the PCB layout, the rate of surrounding airflow, and the difference between the junction and ambient temperatures. The maximum power dissipation can be approximated using the following formula:

$$P_{D(MAX)} = (T_{J(MAX)} - T_A) / \theta_{JA} \quad (3)$$

where  $T_{J(MAX)}$  is the maximum junction temperature,  $T_A$  is the ambient temperature, and  $\theta_{JA}$  is the junction -to-ambient thermal resistance.

**APPLICATION INFORMATION (continued)**

**Negatively Biased Output**

When the output is negative voltage, the chip may not start up due to parasitic effects. Ensure that the output is greater than -0.3V under all conditions. If excessive negatively biased output is expected in the application, a Schottky diode can be added between the OUT pin and GND pin.

**Reverse Current**

The pass transistor has an inherent body diode which will be forward biased in the case when  $V_{OUT} > (V_{IN} + 0.3V)$ . If extended reverse voltage operation is anticipated, external limiting might be appropriate.

**REVISION HISTORY**

NOTE: Page numbers for previous revisions may differ from page numbers in the current version.

<b>DECEMBER 2021 – REV.A.1 to REV.A.2</b>	<b>Page</b>
Updated Electrical Characteristics section .....	5
Updated Typical Performance Characteristics section .....	7, 9
<b>OCTOBER 2021 – REV.A to REV.A.1</b>	<b>Page</b>
Updated Electrical Characteristics section .....	5
<b>Changes from Original (SEPTEMBER 2021) to REV.A</b>	<b>Page</b>
Changed from product preview to production data .....	All

PACKAGE OUTLINE DIMENSIONS

XTDFN-1x1-4L

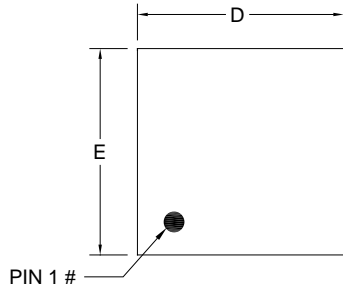

TOP VIEW

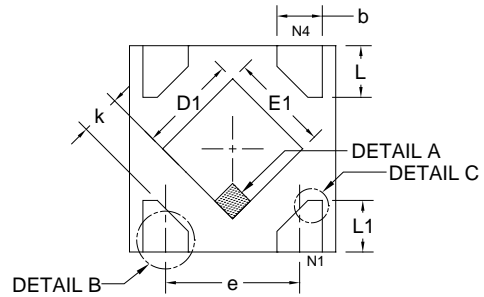

BOTTOM VIEW

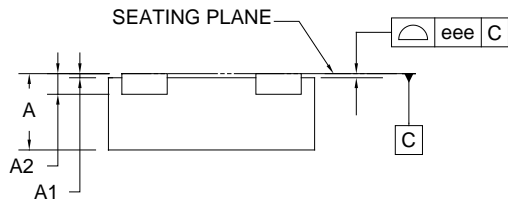

SIDE VIEW

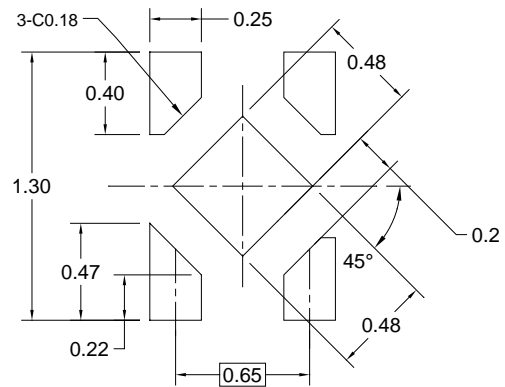

RECOMMENDED LAND PATTERN (Unit: mm)

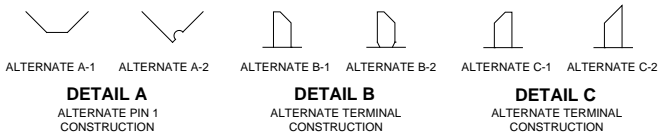

Symbol	Dimensions in Millimeters		
	MIN	MOD	MAX
A	0.340	0.370	0.400
A1	0.000	0.020	0.050
A2	0.100 REF		
b	0.170	-	0.300
D	0.950	1.000	1.050
E	0.950	1.000	1.050
D1	0.430	0.480	0.530
E1	0.430	0.480	0.530
L	0.200	0.250	0.300
L1	0.200	-	0.370
e	0.650 BSC		
k	0.150	-	-
eee	-	0.050	-

NOTE: This drawing is subject to change without notice.

PACKAGE OUTLINE DIMENSIONS

WLCSP-0.64x0.64-4B-A

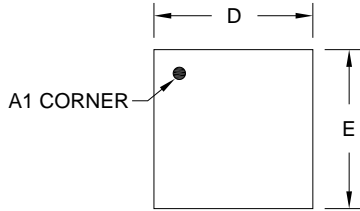

TOP VIEW

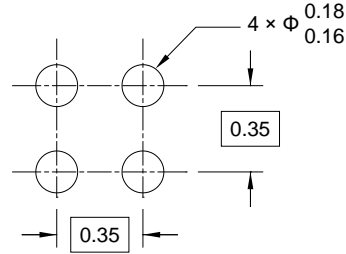

RECOMMENDED LAND PATTERN (Unit: mm)

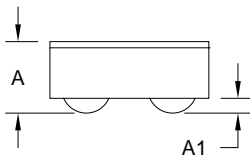

SIDE VIEW

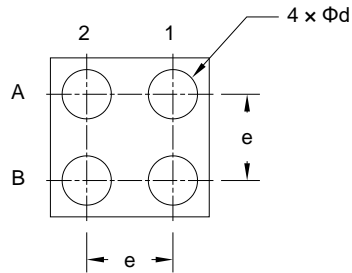

BOTTOM VIEW

Symbol	Dimensions In Millimeters		
	MIN	MOD	MAX
A	0.262	0.290	0.318
A1	0.050	0.060	0.070
D	0.620	0.645	0.670
E	0.620	0.645	0.670
d	0.190	0.200	0.210
e	0.350 BSC		

NOTE: This drawing is subject to change without notice.



TAPE AND REEL INFORMATION

REEL DIMENSIONS

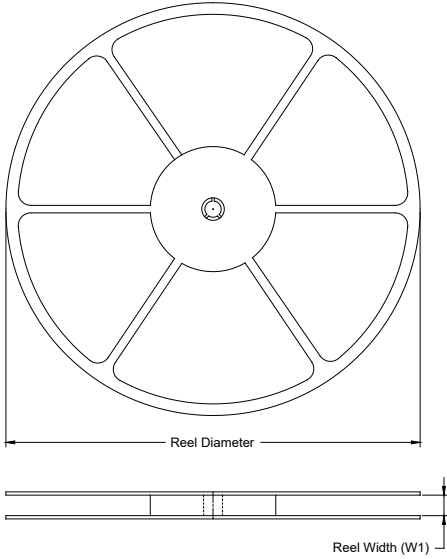

TAPE DIMENSIONS



NOTE: The picture is only for reference. Please make the object as the standard.

KEY PARAMETER LIST OF TAPE AND REEL

Package Type	Reel Diameter	Reel Width W1 (mm)	A0 (mm)	B0 (mm)	K0 (mm)	P0 (mm)	P1 (mm)	P2 (mm)	W (mm)	Pin1 Quadrant
XTDFN-1×1-4L	7"	9.5	1.16	1.16	0.50	4.0	2.0	2.0	8.0	Q1
WLCSP-0.64×0.64-4B-A	7"	9.5	0.74	0.74	0.37	4.0	4.0	2.0	8.0	Q1

DD0001

# PACKAGE INFORMATION

## CARTON BOX DIMENSIONS



NOTE: The picture is only for reference. Please make the object as the standard.

## KEY PARAMETER LIST OF CARTON BOX

Reel Type	Length (mm)	Width (mm)	Height (mm)	Pizza/Carton
7" (Option)	368	227	224	8
7"	442	410	224	18

DD0002

单击下面可查看定价，库存，交付和生命周期等信息

[>>SGMICRO\(圣邦微电子\)](#)