

GENERAL DESCRIPTION

The SGM2225 is a high voltage, low noise and low dropout voltage linear regulator. It is capable of supplying 800mA output current with typical dropout voltage of only 450mV. The operating input voltage range is from 3.6V to 36V.

Other features include logic-controlled shutdown mode, short-circuit current limit and thermal shutdown protection. The SGM2225 has automatic discharge function to quickly discharge V_{OUT} in the disabled status.

The SGM2225 is available in Green SOT-223-3, SOT-89-3, SOIC-8, TDFN-3×3-8L and TO-263-5B packages. It operates over an operating temperature range of -40°C to +125°C.

FEATURES

- **Wide Operating Input Voltage Range: 3.6V to 36V**
- **Fixed Outputs of 1.8V, 2.5V, 3.3V, 5.0V and 12V**
- **Adjustable Output from 1.8V to 15V**
- **Output Voltage Accuracy: $\pm 1.5\%$ at +25°C**
- **Low Dropout Voltage: 450mV (TYP) at 800mA**
- **Current Limiting and Thermal Protection**
- **Excellent Load and Line Transient Responses**
- **With Output Automatic Discharge**
- **No-Load Stability**
- **-40°C to +125°C Operating Temperature Range**
- **Available in Green SOT-223-3, SOT-89-3, SOIC-8, TDFN-3×3-8L and TO-263-5B Packages**

APPLICATIONS

- Cellular Telephones
- Palmtop Computers
- High-Efficiency Linear Power Supplies
- Portable Equipment
- Battery-Powered Systems

TYPICAL APPLICATIONS

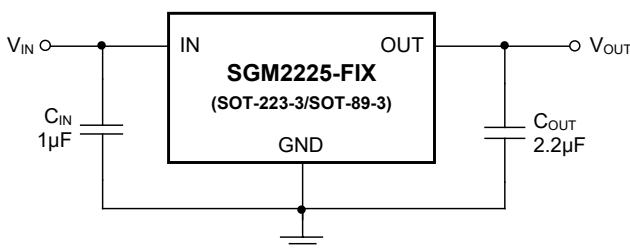

Figure 1. Fixed Voltage Typical Application Circuit

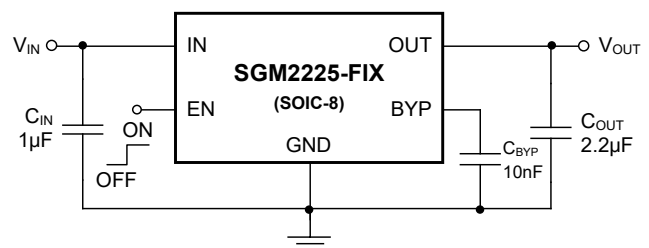

Figure 2. Low Noise Regulator (Fixed Voltage Version)

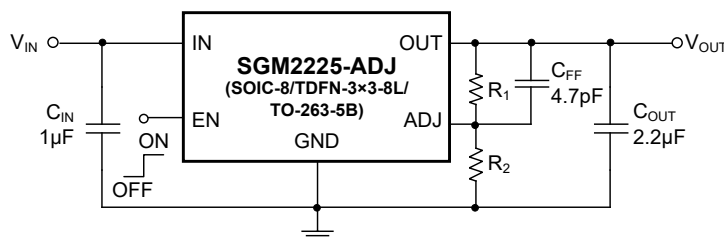

Figure 3. Low Noise Regulator (Adjustable Voltage Version)

PACKAGE/ORDERING INFORMATION

MODEL	PACKAGE DESCRIPTION	SPECIFIED TEMPERATURE RANGE	ORDERING NUMBER	PACKAGE MARKING	PACKING OPTION
SGM2225-1.8	SOT-89-3	-40°C to +125°C	SGM2225-1.8XK3G/TR	RB8XX	Tape and Reel, 1000
SGM2225-2.5	SOT-89-3	-40°C to +125°C	SGM2225-2.5XK3G/TR	025XX	Tape and Reel, 1000
SGM2225-3.3	SOT-89-3	-40°C to +125°C	SGM2225-3.3XK3G/TR	R8CXX	Tape and Reel, 1000
SGM2225-5.0	SOT-89-3	-40°C to +125°C	SGM2225-5.0XK3G/TR	R8DXX	Tape and Reel, 1000
SGM2225-1.8	SOT-223-3	-40°C to +125°C	SGM2225-1.8XKC3G/TR	RB9 XXXXX	Tape and Reel, 2500
SGM2225-2.5	SOT-223-3	-40°C to +125°C	SGM2225-2.5XKC3G/TR	SWG XXXXX	Tape and Reel, 2500
SGM2225-3.3	SOT-223-3	-40°C to +125°C	SGM2225-3.3XKC3G/TR	R8E XXXXX	Tape and Reel, 2500
SGM2225-5.0	SOT-223-3	-40°C to +125°C	SGM2225-5.0XKC3G/TR	R8F XXXXX	Tape and Reel, 2500
SGM2225-12	SOT-223-3	-40°C to +125°C	SGM2225-12XKC3G/TR	R16 XXXXX	Tape and Reel, 2500
SGM2225-2.5	SOIC-8	-40°C to +125°C	SGM2225-2.5XS8G/TR	SGM 222525XS8 XXXXX	Tape and Reel, 4000
SGM2225-3.3	SOIC-8	-40°C to +125°C	SGM2225-3.3XS8G/TR	SGM R90XS8 XXXXX	Tape and Reel, 4000
SGM2225-5.0	SOIC-8	-40°C to +125°C	SGM2225-5.0XS8G/TR	SGM R91XS8 XXXXX	Tape and Reel, 4000
SGM2225-ADJ	SOIC-8	-40°C to +125°C	SGM2225-ADJXS8G/TR	SGM 2225ADJXS8 XXXXX	Tape and Reel, 4000
SGM2225-1.8	TDFN-3×3-8L	-40°C to +125°C	SGM2225-1.8XTDB8G/TR	SGM SVPDB XXXXX	Tape and Reel, 4000
SGM2225-2.5	TDFN-3×3-8L	-40°C to +125°C	SGM2225-2.5XTDB8G/TR	SGM 026DB XXXXX	Tape and Reel, 4000
SGM2225-3.3	TDFN-3×3-8L	-40°C to +125°C	SGM2225-3.3XTDB8G/TR	SGM R92DB XXXXX	Tape and Reel, 4000
SGM2225-5.0	TDFN-3×3-8L	-40°C to +125°C	SGM2225-5.0XTDB8G/TR	SGM R93DB XXXXX	Tape and Reel, 4000
SGM2225-ADJ	TDFN-3×3-8L	-40°C to +125°C	SGM2225-ADJXTDB8G/TR	SGM R15DB XXXXX	Tape and Reel, 4000

PIN CONFIGURATIONS

SGM2225-FIX (TOP VIEW)

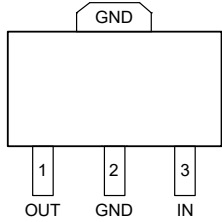

SOT-89-3

SGM2225-FIX (TOP VIEW)

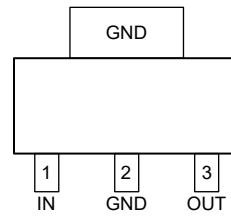

SOT-223-3

SGM2225-FIX (TOP VIEW)

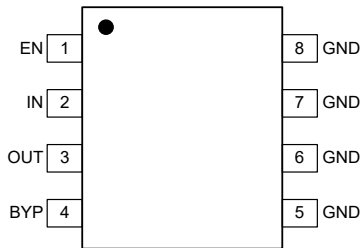

SOIC-8

SGM2225-ADJ (TOP VIEW)

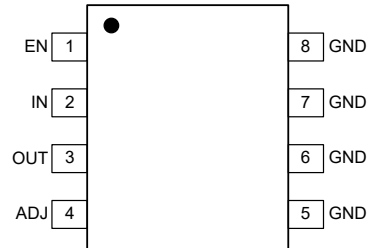

SOIC-8

SGM2225-FIX (TOP VIEW)

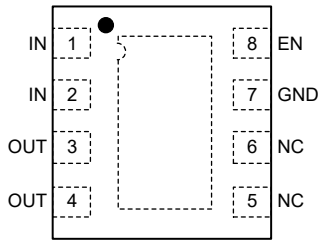

TDFN-3x3-8L

SGM2225-ADJ (TOP VIEW)

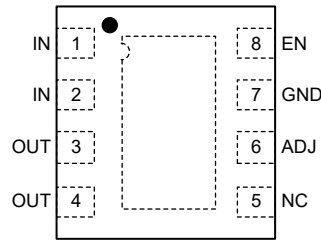

TDFN-3x3-8L

SGM2225-ADJ (TOP VIEW)

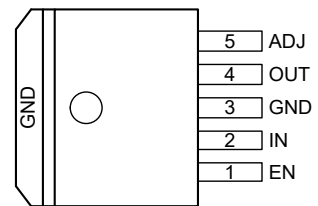

TO-263-5B

PIN DESCRIPTION

PIN					NAME	FUNCTION
SOT-89-3	SOT-223-3	SOIC-8	TDFN-3x3-8L	TO-263-5B		
1	3	3	3, 4	4	OUT	Regulator Output Pin. It is recommended to use an output capacitor with effective capacitance in the range of 1μF to 10μF to ensure stability. Pins 3 and 4 must be tied together for TDFN-3x3-8L package.
2	2	5-8	7	3	GND	Ground. Pins 5 to 8 are internally connected for SOIC-8 package.
3	1	2	1, 2	2	IN	Input Supply Voltage Pin. It is recommended to use a 1μF or larger ceramic capacitor from IN pin to ground to get good power supply decoupling.
-	-	1	8	1	EN	Enable Pin. Drive EN high to turn on the regulator. Drive EN low to turn off the regulator.
-	-	4	-	-	BYP	Reference Bypass Pin (fixed voltage version only). Bypass with an external capacitor C _{BYP} can reduce output noise to very low level.
-	-	4	6	5	ADJ	Feedback Voltage Input Pin (adjustable voltage version only). Connect this pin to the midpoint of an external resistor divider to adjust the output voltage. Place the resistors as close as possible to this pin.
-	-	-	5	-	NC	No Connection.
-	-	-	6	-	NC	No Connection (fixed voltage version only).
-	-	-	Exposed Pad	-	GND	Exposed Pad. Exposed pad is internally connected to GND. Connect it to a large ground plane to maximize thermal performance. This pad is not an electrical connection point.

ELECTRICAL CHARACTERISTICS

($V_{IN} = V_{OUT(NOM)} + 1V$, $I_{OUT} = 100\mu A$ and $C_{OUT} = 2.2\mu F$, $T_J = -40^\circ C$ to $+125^\circ C$, typical values are at $T_J = +25^\circ C$, unless otherwise noted.)

PARAMETER	SYMBOL	CONDITIONS	MIN	TYP	MAX	UNITS
Input Voltage Range	V_{IN}	$T_J = +25^\circ C$	3.6		36	V
Output Voltage Accuracy	V_{OUT}	Variation from nominal V_{OUT} , $T_J = +25^\circ C$	-1.5		1.5	%
		Variation from nominal V_{OUT}	-2		2	
Reference Voltage	V_{REF}	$T_J = +25^\circ C$	1.182	1.2	1.218	V
			1.176		1.224	
Line Regulation	$\frac{\Delta V_{OUT}}{\Delta V_{IN} \times V_{OUT}}$	$V_{IN} = V_{OUT(NOM)} + 1V$ to 36V, $T_J = +25^\circ C$		0.0003	0.003	%V
		$V_{IN} = V_{OUT(NOM)} + 1V$ to 36V			0.005	
Load Regulation	$\frac{\Delta V_{OUT}}{V_{OUT}}$	$I_{OUT} = 100\mu A$ to 800mA, $T_J = +25^\circ C$		0.1	0.3	%
		$I_{OUT} = 100\mu A$ to 800mA			0.4	
Dropout Voltage ⁽¹⁾	V_{DROPO}	$I_{OUT} = 50mA$, $T_J = +25^\circ C$		30	38	mV
		$I_{OUT} = 50mA$			55	
		$I_{OUT} = 200mA$, $T_J = +25^\circ C$		115	150	
		$I_{OUT} = 200mA$			210	
		$I_{OUT} = 800mA$, $T_J = +25^\circ C$		450	610	
		$I_{OUT} = 800mA$			850	
Output Current Limit	I_{LIMIT}	$V_{OUT} = 90\% \times V_{OUT(NOM)}$, $T_J = +25^\circ C$	820	1100		mA
Short-Circuit Current	I_{SHORT}	$V_{IN} = V_{EN} = 3V$, $V_{OUT} = 0V$		230		mA
Ground Pin Current	I_Q	$V_{EN} \geq 1.6V$, no load, $T_J = +25^\circ C$		80	104	μA
		$V_{EN} \geq 1.6V$, no load			112	
		$V_{EN} \geq 1.6V$, $I_{OUT} = 100\mu A$, $T_J = +25^\circ C$		80	104	
		$V_{EN} \geq 1.6V$, $I_{OUT} = 100\mu A$			112	
		$V_{EN} \geq 1.6V$, $I_{OUT} = 50mA$, $T_J = +25^\circ C$		220	280	
		$V_{EN} \geq 1.6V$, $I_{OUT} = 50mA$			290	
		$V_{EN} \geq 1.6V$, $I_{OUT} = 800mA$, $T_J = +25^\circ C$		1950	2250	
		$V_{EN} \geq 1.6V$, $I_{OUT} = 800mA$			2350	
Ground Pin Quiescent Current	$I_{Q(GND)}$	$V_{EN} \leq 0.4V$ (shutdown), $T_J = +25^\circ C$		6.5	8	μA
		$V_{EN} \leq 0.4V$ (shutdown)			12	
Enable Input Logic-Low Voltage	V_{ENL}	$V_{EN} = \text{logic low}$ (regulator shutdown)			0.4	V
		$V_{EN} = \text{logic high}$ (regulator enabled)	1.6			
Enable Input Current	I_{ENL}	$V_{ENL} \leq 0.4V$			1	μA
	I_{ENH}	$V_{ENH} \geq 1.6V$			1	
Power Supply Rejection Ratio	PSRR	$f = 1kHz$, $V_{OUT} = 2.5V$, $I_{OUT} = 50mA$		75		dB
Output Voltage Noise	e_n	$V_{OUT} = 2.5V$, $I_{OUT} = 50mA$, $C_{BYP} = 0\mu F$		500		nV/ \sqrt{Hz}
Output Voltage Temperature Coefficient	$\frac{\Delta V_{OUT}}{\Delta T_J \times V_{OUT}}$			40		ppm/ $^\circ C$
Thermal Shutdown Temperature	T_{SHDN}			155		$^\circ C$
Thermal Shutdown Hysteresis	ΔT_{SHDN}			25		$^\circ C$

NOTE:

1. The dropout voltage is defined as the difference between V_{IN} and V_{OUT} when V_{OUT} falls to $95\% \times V_{OUT(NOM)}$.

TYPICAL PERFORMANCE CHARACTERISTICS

T_J = +25°C, C_{OUT} = 2.2µF and I_{OUT} = 100µA, unless otherwise noted.

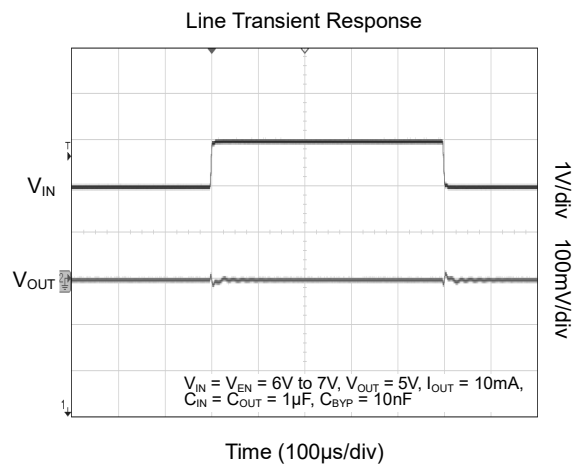
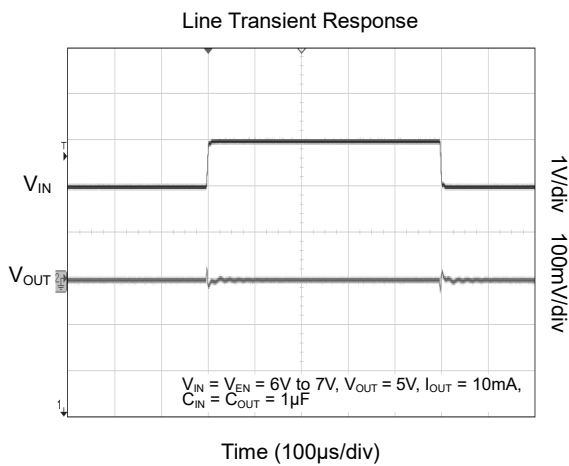
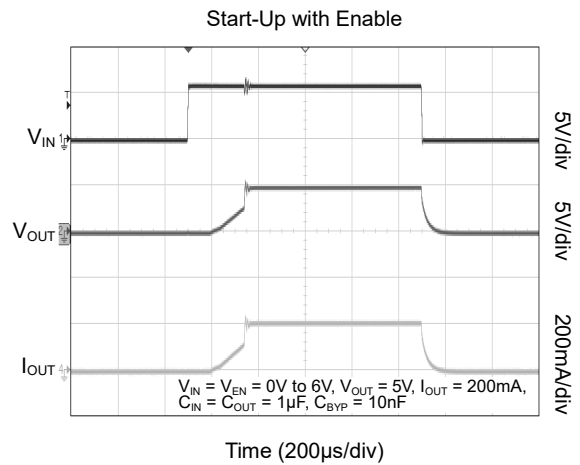
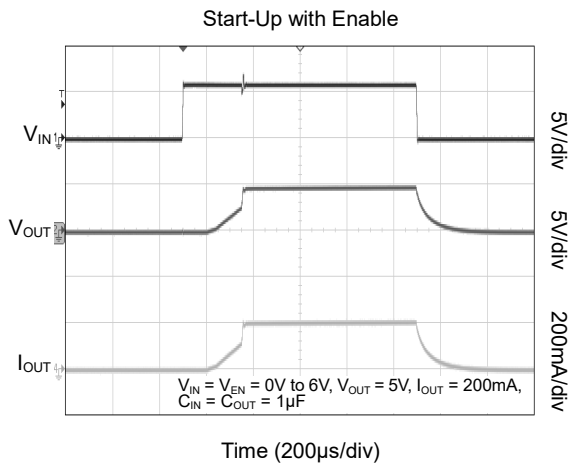
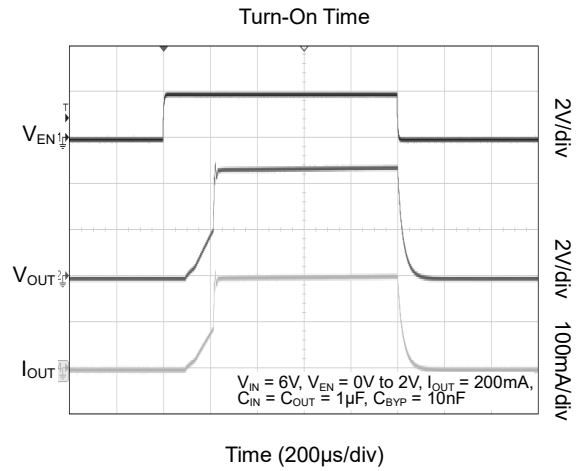
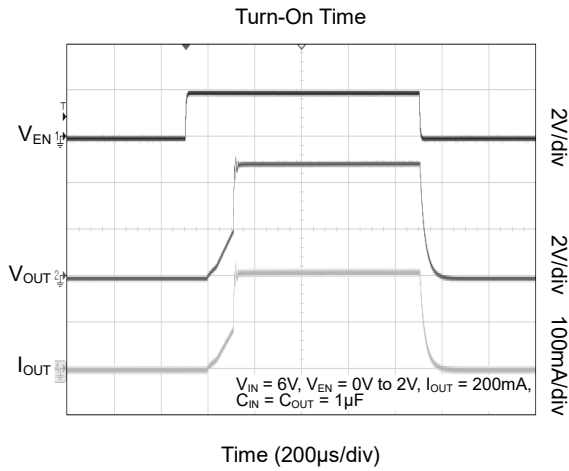

TYPICAL PERFORMANCE CHARACTERISTICS (continued)

T_J = +25°C, C_{OUT} = 2.2µF and I_{OUT} = 100µA, unless otherwise noted.

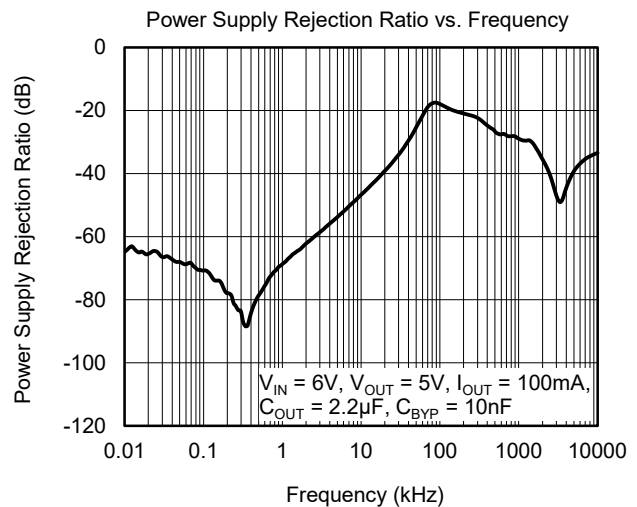
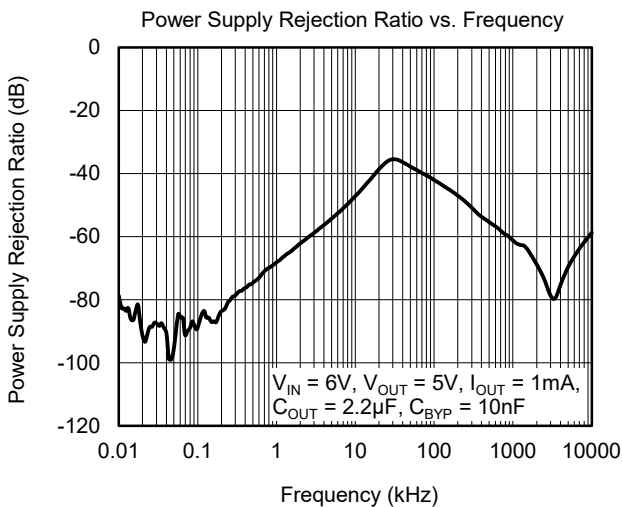
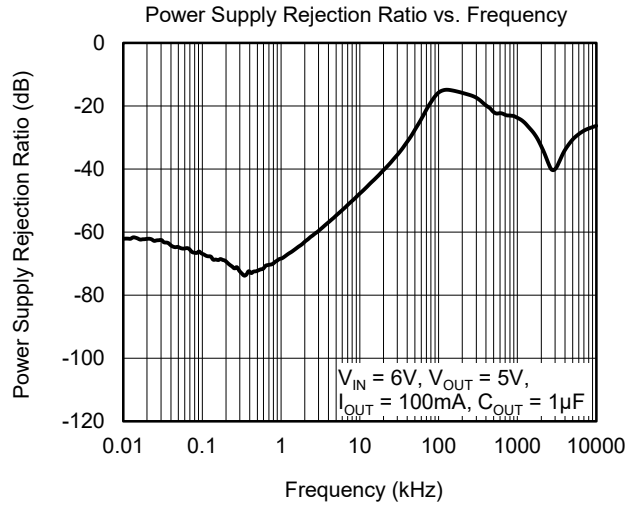
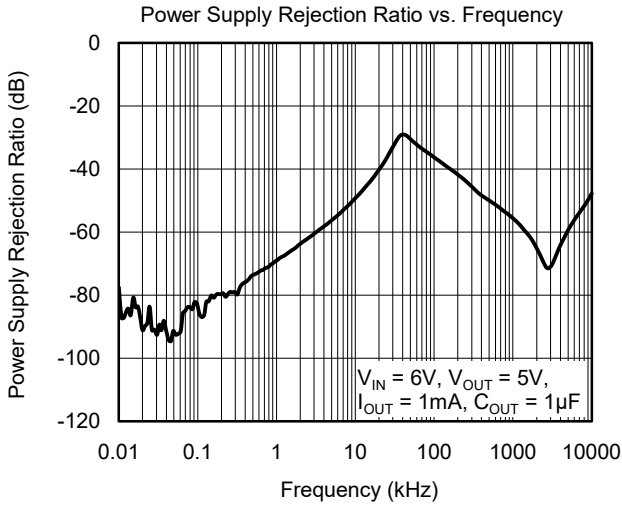
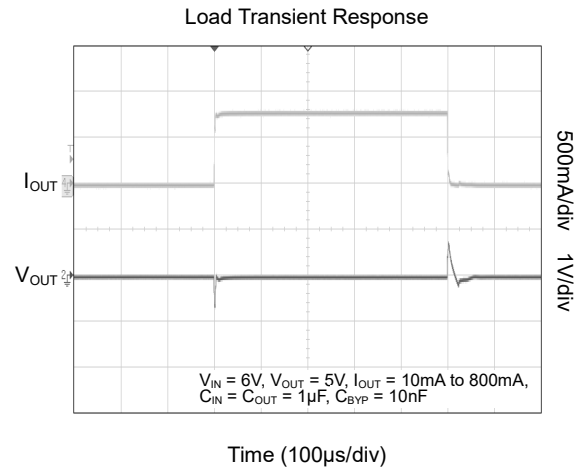
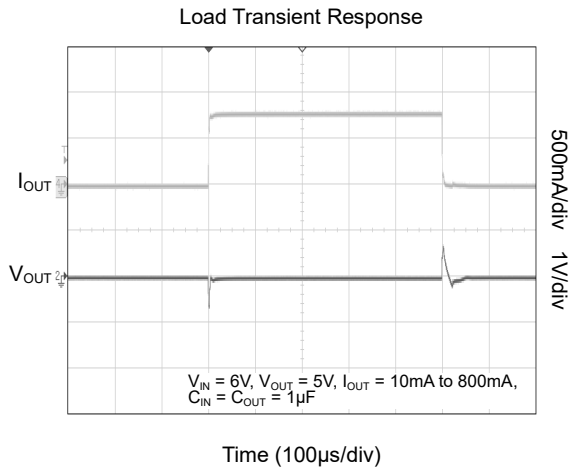

TYPICAL PERFORMANCE CHARACTERISTICS (continued)

T_J = +25°C, C_{OUT} = 2.2μF and I_{OUT} = 100μA, unless otherwise noted.

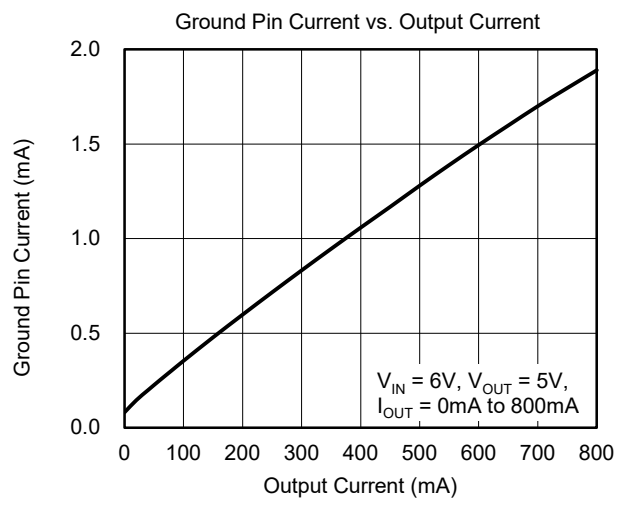
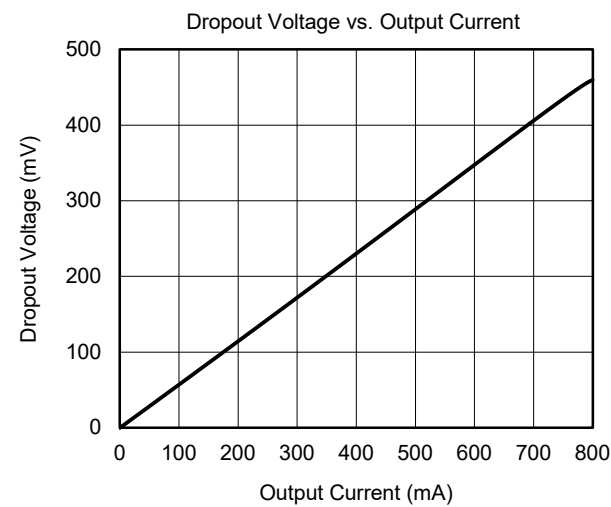
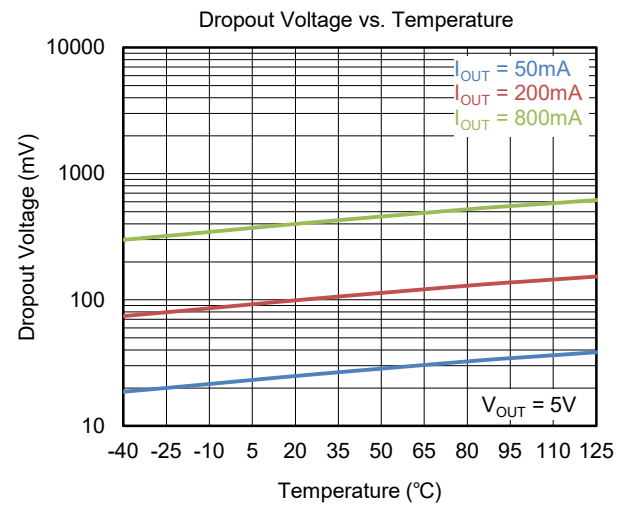
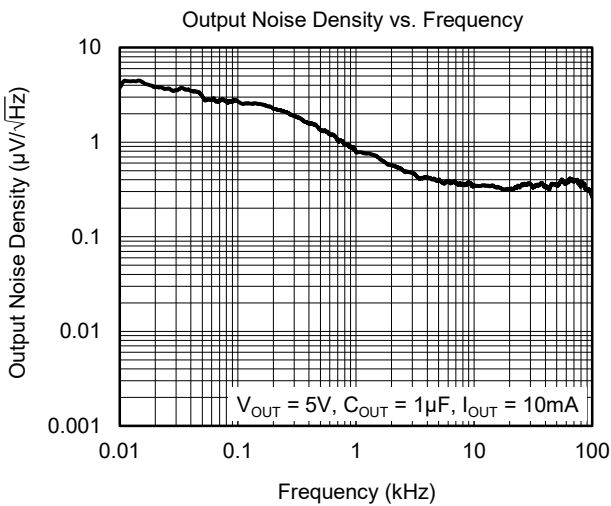
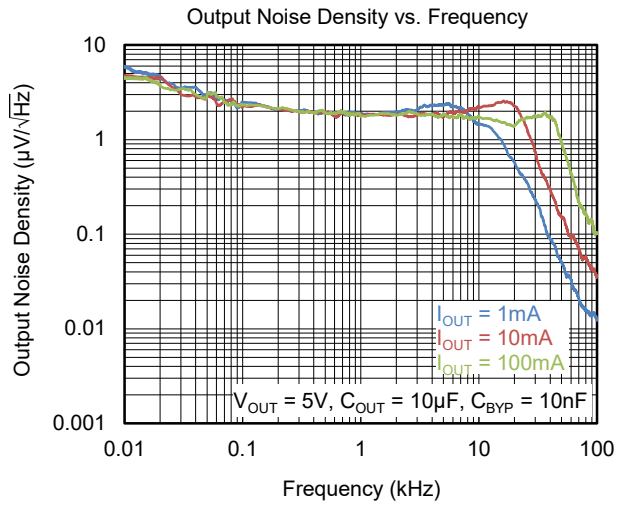
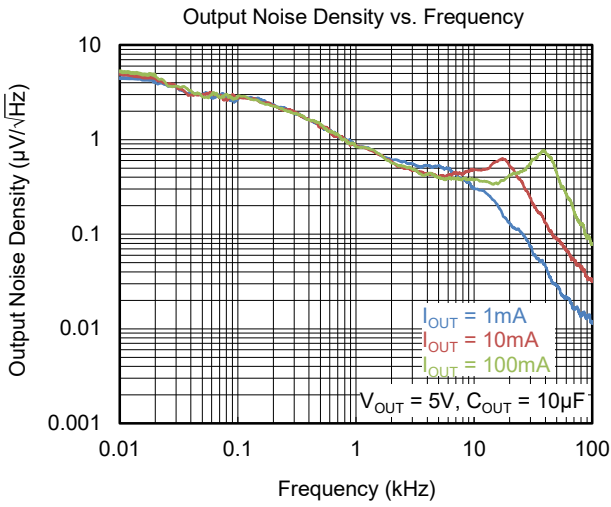

TYPICAL PERFORMANCE CHARACTERISTICS (continued)

T_J = +25°C, C_{OUT} = 2.2µF and I_{OUT} = 100µA, unless otherwise noted.

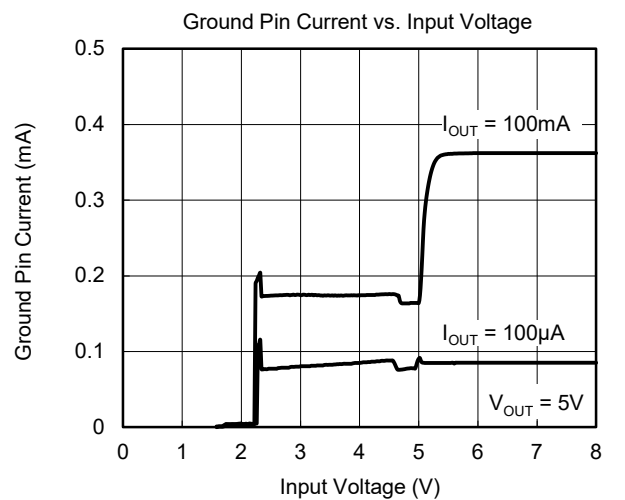
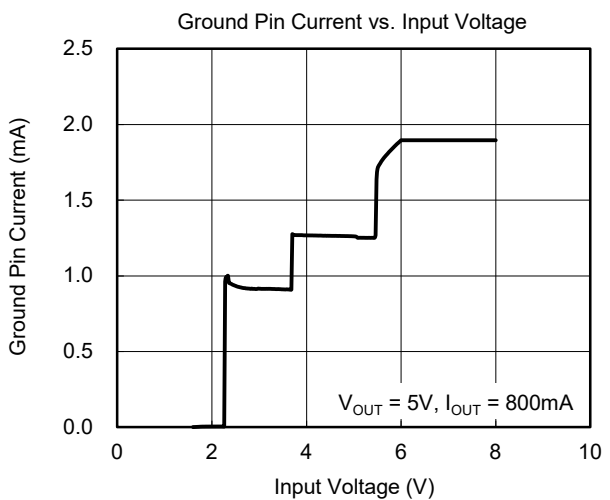
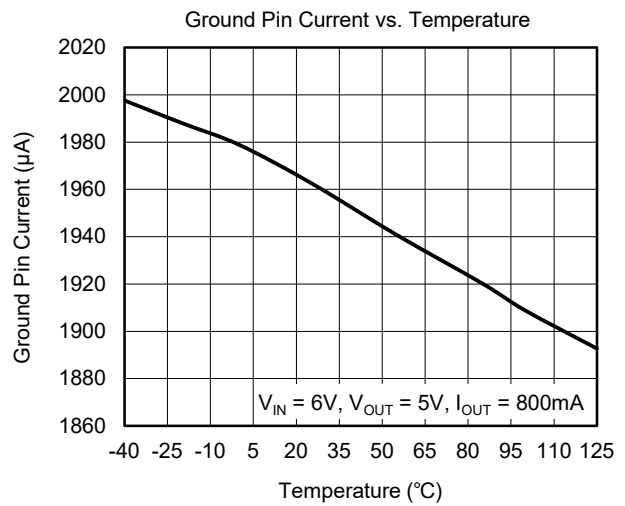
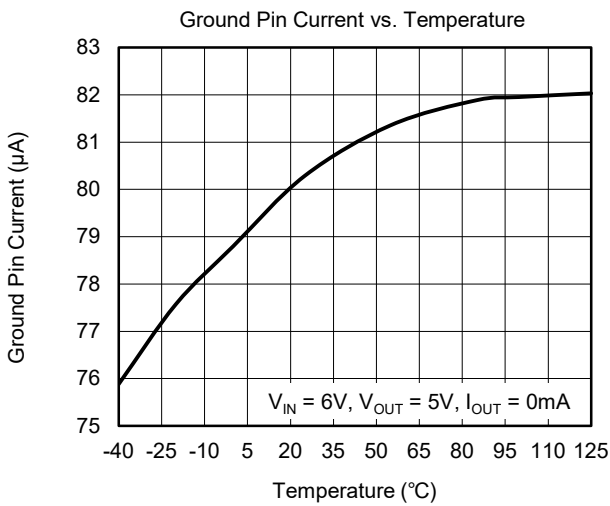
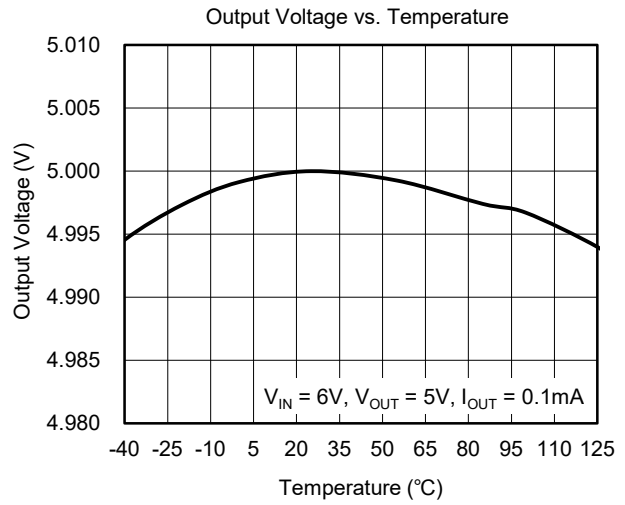
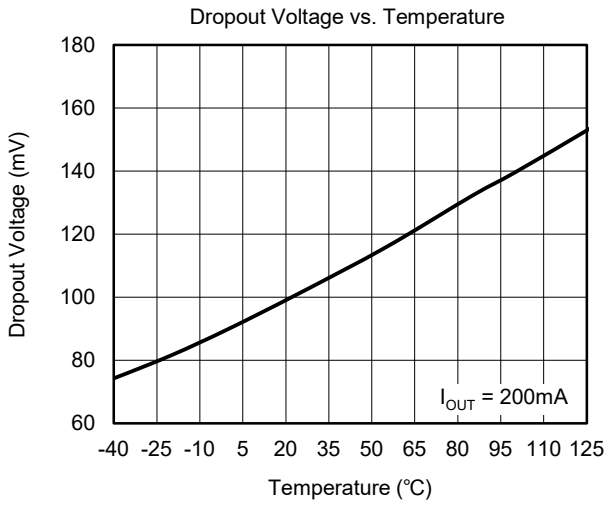

FUNCTIONAL BLOCK DIAGRAMS

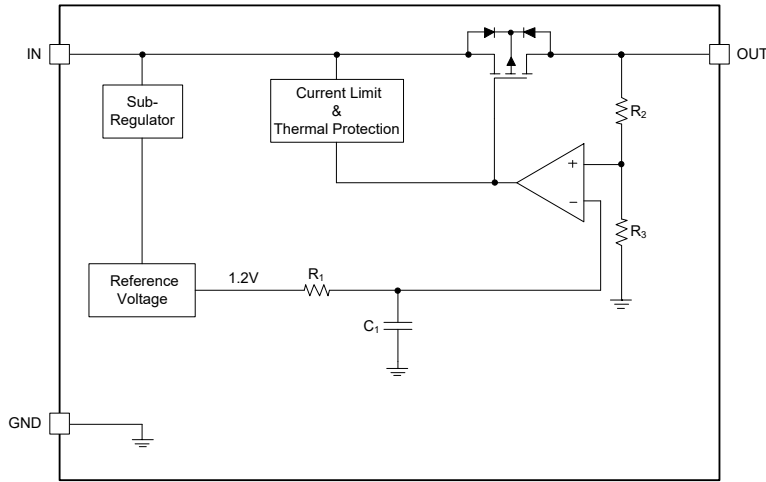

Figure 4. Internal Block Diagram of Fixed Output Voltage (SOT-89-3 and SOT-223-3 Versions)

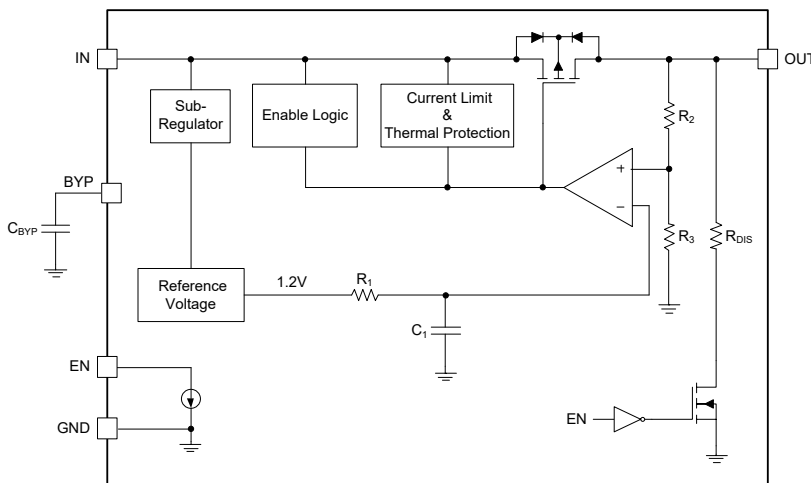

Figure 5. Internal Block Diagram of Low Noise Fixed Regulator (SOIC-8 Version)

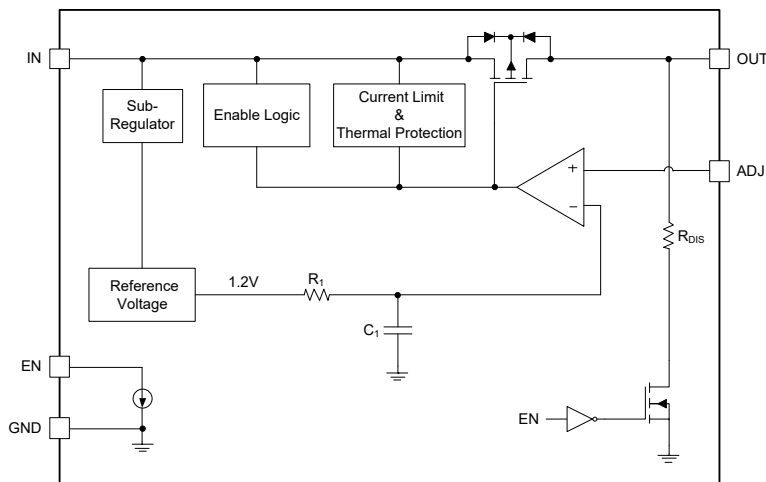

Figure 6. Internal Block Diagram of Adjustable Output Voltage (SOIC-8, TDFN-3x3-8L and TO-263-5B Versions)

APPLICATION INFORMATION

The SGM2225 is a high voltage, low noise and low dropout LDO and provides 800mA output current. These features make the device a reliable solution to solve many challenging problems in the generation of clean and accurate power supply. The high performance also makes the SGM2225 useful in a variety of applications. The SGM2225 provides protection functions for output overload, output short-circuit condition and overheating.

The SGM2225 provides an EN pin as an external chip enable control to enable/disable the device.

Input Capacitor Selection (C_{IN})

The input decoupling capacitor should be placed as close as possible to the IN pin for ensuring the device stability. 1 μ F or larger X7R or X5R ceramic capacitor is selected to get good dynamic performance.

When V_{IN} is required to provide large current instantaneously, a large effective input capacitor is required. Multiple input capacitors can limit the input tracking inductance. Adding more input capacitors is available to restrict the ringing and to keep it below the device absolute maximum ratings.

Output Capacitor Selection (C_{OUT})

The output capacitor should be placed as close as possible to the OUT pin. 2.2 μ F or larger X7R or X5R ceramic capacitor is selected to get good dynamic performance. The minimum effective capacitance of C_{OUT} that SGM2225 can remain stable is 1 μ F. For ceramic capacitor, temperature, DC bias and package size will change the effective capacitance, so enough margin of C_{OUT} must be considered in design. Additionally, C_{OUT} with larger capacitance and lower ESR will help increase the high frequency PSRR and improve the load transient response.

Noise Bypass Capacitor (C_{BYP})

In noise sensitive applications, a bypass capacitor can be connected to the BYP pin (SOIC-8 package only) to reduce the noise of output voltage. A 10nF ceramic capacitor is recommended in application.

No-Load Stability

The SGM2225 can maintain stability without output load (except internal voltage divider).

Input Power Supply

The input power supply range is from 3.6V to 36V. V_{IN} must be larger than ($V_{OUT} + V_{DROP}$) in application. The input ceramic capacitor must be placed as close as possible to the IN pin, this C_{IN} can help improve the output noise performance of LDO.

Adjustable Regulator

The output voltage of the SGM2225-ADJ can be adjusted from 1.8V to 15V. The ADJ pin will be connected to two external resistors as shown in Figure 7, the output voltage is determined by the following equation:

$$V_{OUT} = V_{REF} \times \left(1 + \frac{R_1}{R_2}\right) \quad (1)$$

where:

V_{OUT} is output voltage and V_{REF} is the internal voltage reference, $V_{REF} = 1.2V$.

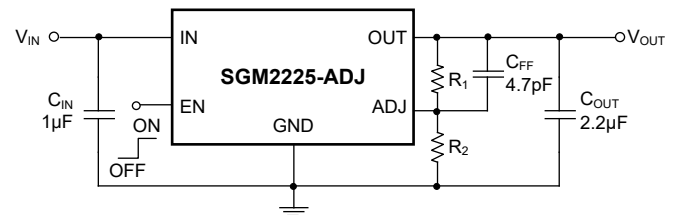

Figure 7. Adjustable Output Voltage Application

R_1 and R_2 can be calculated for any output voltage range using equation 1 and R_1 is recommended to be less than 470k Ω .

Enable Operation

The EN pin of the SGM2225 is used to enable/disable the device and to deactivate/activate the output automatic discharge function.

When the EN pin voltage is lower than 0.4V, the device is in shutdown state. There is no current flowing from IN to OUT pins. In this state, the automatic discharge transistor is active to discharge the output voltage through a resistor.

When the EN pin voltage is higher than 1.6V, the device is in active state. The output voltage is regulated to the expected value and the automatic discharge transistor is turned off.

APPLICATION INFORMATION (continued)

Output Current Limit and Short-Circuit Protection

When overload events happen, the output current is internally limited to 1100mA (TYP). When the OUT pin is shorted to ground, the short-circuit protection will limit the output current to 230mA (TYP).

Thermal Shutdown

When the die temperature exceeds the threshold value of thermal shutdown, the SGM2225 will be in shutdown state and remain in this state until the die temperature decreases to +130°C.

Power Dissipation (P_D)

Power dissipation (P_D) of the SGM2225 can be calculated by the equation P_D = (V_{IN} - V_{OUT}) × I_{OUT}. The

maximum allowable power dissipation (P_{D(MAX)}) of the SGM2225 is affected by many factors, including the difference between junction temperature and ambient temperature (T_{J(MAX)} - T_A), package thermal resistance from the junction to the ambient environment (θ_{JA}), the rate of ambient airflow and PCB layout. P_{D(MAX)} can be approximated by the following equation:

$$P_{D(MAX)} = (T_{J(MAX)} - T_A) / \theta_{JA} \quad (2)$$

Layout Guidelines

To get good PSRR, low output noise and high transient response performance, the input and output bypass capacitors must be placed as close as possible to the IN pin and OUT pin separately.

REVISION HISTORY

NOTE: Page numbers for previous revisions may differ from page numbers in the current version.

DECEMBER 2023 – REV.A.3 to REV.A.4	Page
Updated Package Outline Dimensions.....	13
Updated Absolute Maximum Ratings section.....	3
NOVEMBER 2022 – REV.A.2 to REV.A.3	Page
Updated Typical Performance Characteristics section	9
APRIL 2022 – REV.A.1 to REV.A.2	Page
Added SGM2225-2.5XK3G/TR, SGM2225-2.5XS8G/TR and SGM2225-2.5XTDB8G/TR versions.....	All
Updated Electrical Characteristics section	5
MARCH 2021 – REV.A to REV.A.1	Page
Added SGM2225-2.5XKC3G/TR version	All
Updated Electrical Characteristics section	5
Changes from Original (MARCH 2021) to REV.A	Page
Changed from product preview to production data.....	All

PACKAGE OUTLINE DIMENSIONS

SOT-89-3

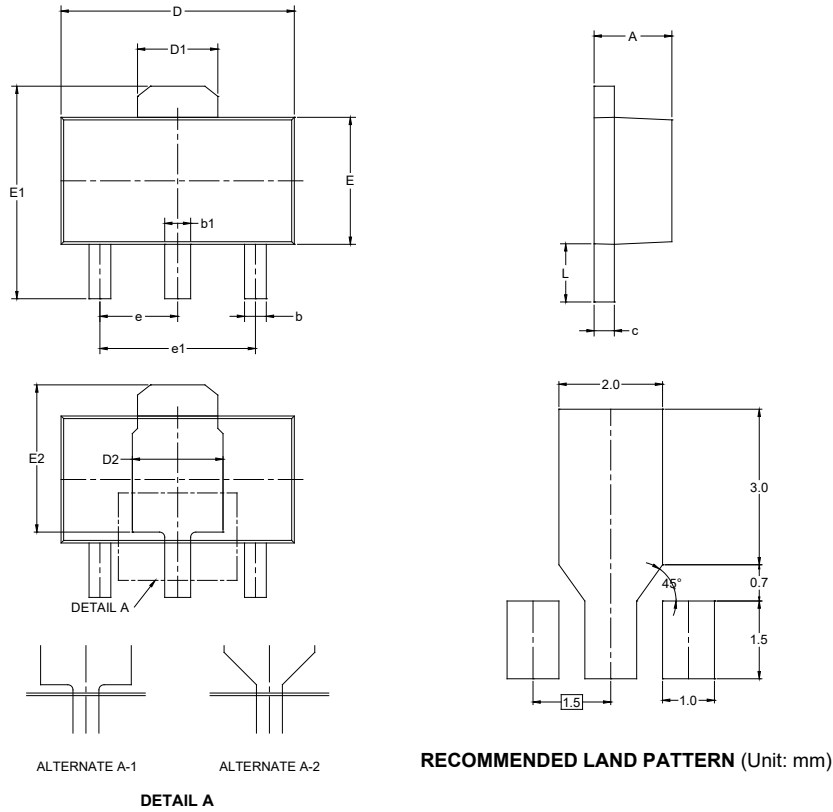

Symbol	Dimensions In Millimeters		
	MIN	MOD	MAX
A	1.400	-	1.600
b	0.320	-	0.520
b1	0.400	-	0.580
c	0.350	-	0.440
D	4.400	-	4.600
D1	1.550 REF		
D2	1.750 REF		
E	2.300	-	2.600
E1	3.940	-	4.250
E2	2.840 REF		
e	1.500 BSC		
e1	3.000 BSC		
L	0.900	-	1.200

NOTES:

1. This drawing is subject to change without notice.
2. The dimensions do not include mold flashes, protrusions or gate burrs.
3. Reference JEDEC TO-243.

PACKAGE OUTLINE DIMENSIONS

SOT-223-3

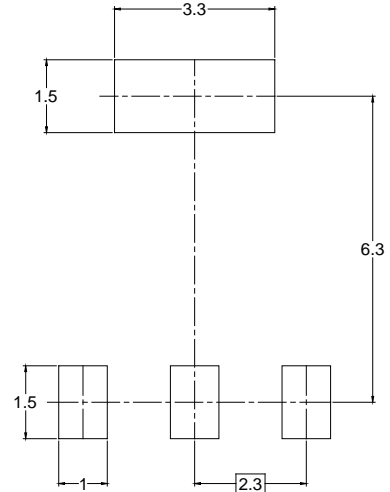
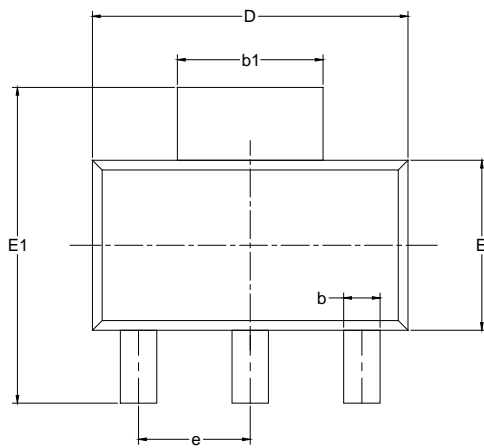

RECOMMENDED LAND PATTERN (Unit: mm)

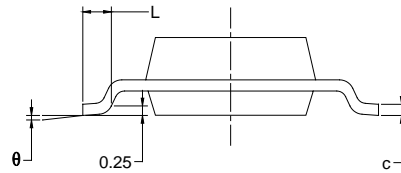
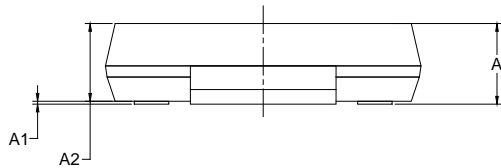

Symbol	Dimensions In Millimeters		Dimensions In Inches	
	MIN	MAX	MIN	MAX
A		1.800		0.071
A1	0.020	0.100	0.001	0.004
A2	1.500	1.700	0.059	0.067
b	0.660	0.840	0.026	0.033
b1	2.900	3.100	0.114	0.122
c	0.230	0.350	0.009	0.014
D	6.300	6.700	0.248	0.264
E	3.300	3.700	0.130	0.146
E1	6.700	7.300	0.264	0.287
e	2.300 BSC		0.091 BSC	
L	0.750		0.030	
θ	0°	10°	0°	10°

NOTES:

1. Body dimensions do not include mode flash or protrusion.
2. This drawing is subject to change without notice.

PACKAGE OUTLINE DIMENSIONS

SOIC-8

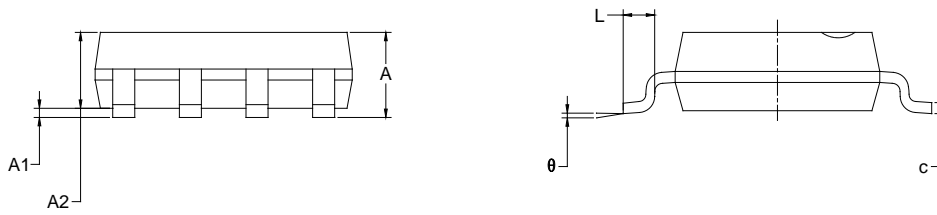
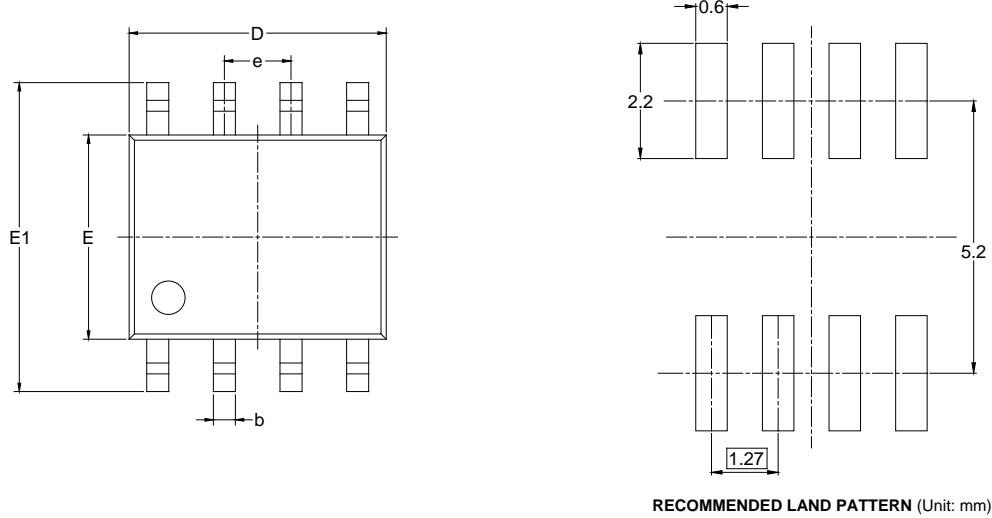

Symbol	Dimensions In Millimeters		Dimensions In Inches	
	MIN	MAX	MIN	MAX
A	1.350	1.750	0.053	0.069
A1	0.100	0.250	0.004	0.010
A2	1.350	1.550	0.053	0.061
b	0.330	0.510	0.013	0.020
c	0.170	0.250	0.006	0.010
D	4.700	5.100	0.185	0.200
E	3.800	4.000	0.150	0.157
E1	5.800	6.200	0.228	0.244
e	1.27 BSC		0.050 BSC	
L	0.400	1.270	0.016	0.050
θ	0°	8°	0°	8°

NOTES:
 1. Body dimensions do not include mode flash or protrusion.
 2. This drawing is subject to change without notice.

PACKAGE INFORMATION

PACKAGE OUTLINE DIMENSIONS

TDFN-3x3-8L

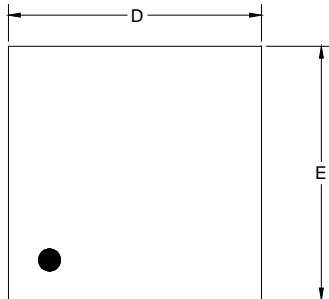

TOP VIEW

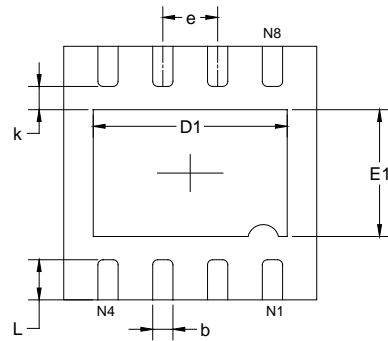

BOTTOM VIEW

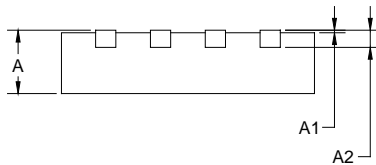

SIDE VIEW

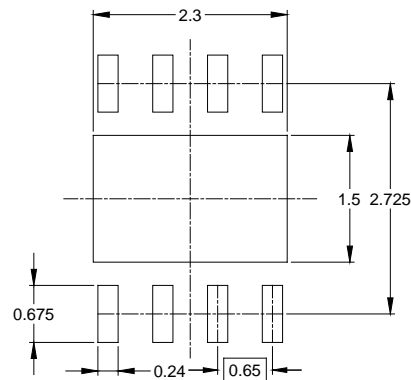

RECOMMENDED LAND PATTERN (Unit: mm)

Symbol	Dimensions In Millimeters		Dimensions In Inches	
	MIN	MAX	MIN	MAX
A	0.700	0.800	0.028	0.031
A1	0.000	0.050	0.000	0.002
A2	0.203 REF		0.008 REF	
D	2.900	3.100	0.114	0.122
D1	2.200	2.400	0.087	0.094
E	2.900	3.100	0.114	0.122
E1	1.400	1.600	0.055	0.063
k	0.200 MIN		0.008 MIN	
b	0.180	0.300	0.007	0.012
e	0.650 TYP		0.026 TYP	
L	0.375	0.575	0.015	0.023

NOTE: This drawing is subject to change without notice.

PACKAGE OUTLINE DIMENSIONS

TO-263-5B

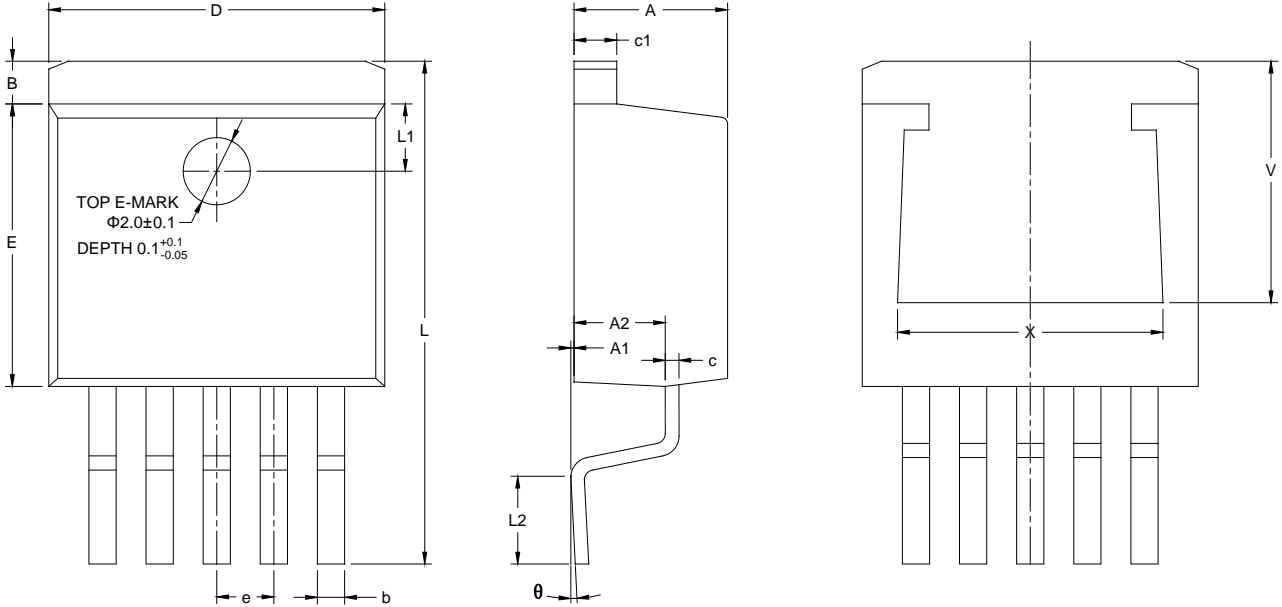

Symbol	Dimensions In Millimeters		
	MIN	MOD	MAX
A	4.40	4.57	4.70
A1	0	0.10	0.25
A2	2.59	2.69	2.79
b	0.77	-	0.90
c	0.34	-	0.47
c1	1.22	-	1.32
e	1.70 BSC		
D	10.06	10.16	10.26
E	9.05	9.15	9.25
B	1.17	1.27	1.40
V	6.86	-	7.50
X	7.50	-	8.30
L	14.70	15.10	15.50
L1	2.00 REF		
L2	2.00	2.30	2.60
theta	0°	-	8°

NOTES:
 1. Body dimensions do not include mode flash or protrusion.
 2. This drawing is subject to change without notice.

TAPE AND REEL INFORMATION

REEL DIMENSIONS

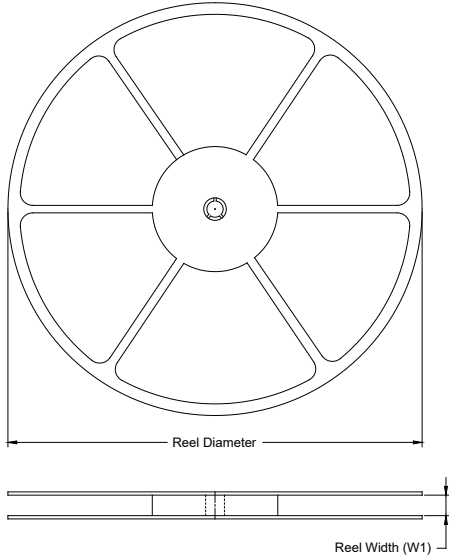

TAPE DIMENSIONS



NOTE: The picture is only for reference. Please make the object as the standard.

KEY PARAMETER LIST OF TAPE AND REEL

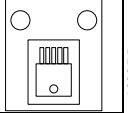
Package Type	Reel Diameter	Reel Width W1 (mm)	A0 (mm)	B0 (mm)	K0 (mm)	P0 (mm)	P1 (mm)	P2 (mm)	W (mm)	Pin1 Quadrant
SOT-89-3	7"	13.2	4.85	4.45	1.85	4.0	8.0	2.0	12.0	Q3
SOT-223-3	13"	12.4	6.55	7.25	1.90	4.0	8.0	2.0	12.0	Q3
SOIC-8	13"	12.4	6.40	5.40	2.10	4.0	8.0	2.0	12.0	Q1
TDFN-3×3-8L	13"	12.4	3.35	3.35	1.13	4.0	8.0	2.0	12.0	Q1
TO-263-5B	13"	24.4	10.80	16.30	5.11	4.0	16.0	2.0	24.0	

PACKAGE INFORMATION

CARTON BOX DIMENSIONS

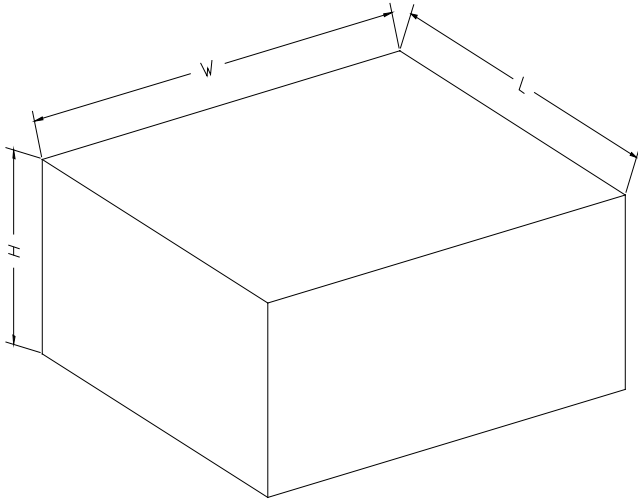

NOTE: The picture is only for reference. Please make the object as the standard.

KEY PARAMETER LIST OF CARTON BOX

Reel Type	Length (mm)	Width (mm)	Height (mm)	Pizza/Carton
7" (Option)	368	227	224	8
7"	442	410	224	18
13"	386	280	370	5

DD0002

单击下面可查看定价，库存，交付和生命周期等信息

[>>SGMICRO\(圣邦微电子\)](#)