



SGM6014

1.4MHz, 2A Synchronous Buck Converter

GENERAL DESCRIPTION

The SGM6014 is a high-efficient monolithic synchronous buck regulator with a wide input voltage range of 2.5V to 5.5V. The device is available in a 3.3V fixed output and an adjustable voltage versions. This device is targeted at the portable equipment with high current requirements from single-cell Li-Ion batteries. It can enter pulse frequency modulation (PFM) (low I_Q) mode with typically 55 μ A quiescent current for highest light load efficiency to maximize battery life.

The SGM6014 could operate at 100% duty cycle to achieve the lowest dropout and longer battery life. This device is capable to provide up to 2A output load current and operates at a 1.4MHz constant frequency to achieve the smallest size of external components. The internal slope compensation allows the use of smaller-value inductors to give improved solution size to this device.

SGM6014 is available in both adjustable and 3.3V fixed output voltage versions; in the Green TDFN-3 \times 3-10L package. It is rated over the -40 $^{\circ}$ C to +85 $^{\circ}$ C temperature range.

FEATURES

- 2.5V to 5.5V Input Voltage Range
- Up to 95% High Efficiency
- 1.4MHz Constant Frequency Operation
- 2A Output Current
- 3.3V Fixed and Adjustable Output Voltages
- 100% Duty Cycle for Lowest Dropout
- Shutdown Current: 2 μ A (MAX)
- Low Quiescent Current: 55 μ A in PFM Mode
- 135m Ω Low $R_{DS(ON)}$ Internal Switches
- Support Ceramic Capacitors
- Current Mode Control for Excellent Line and Load Transient Responses
- Internal Soft-Start Protection
- Short Circuit and Thermal Protection
- -40 $^{\circ}$ C to +85 $^{\circ}$ C Operating Temperature Range
- Available in a Green TDFN-3 \times 3-10L Package

APPLICATIONS

PDA, Pocket PC and Smart Phones
USB Powered Modems
CPUs and DSPs
PC Cards and Notebooks
Mobile Phones
Digital Cameras
DSP Core Supplies
Portable Equipment

PACKAGE/ORDERING INFORMATION

MODEL	V _{OUT} (V)	PACKAGE DESCRIPTION	SPECIFIED TEMPERATURE RANGE	ORDERING NUMBER	PACKAGE MARKING	PACKING OPTION
SGM6014	Adjustable	TDFN-3×3-10L	-40°C to +85°C	SGM6014-ADJYTD10G/TR	SGM SHDD XXXXX	Tape and Reel, 3000
	3.3	TDFN-3×3-10L	-40°C to +85°C	SGM6014-3.3YTD10G/TR	SGM SIBD XXXXX	Tape and Reel, 3000

MARKING INFORMATION

NOTE: XXXXX = Date Code and Vendor Code.

XXXXX

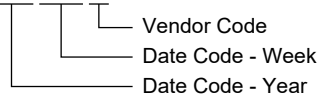

Green (RoHS & HSF): SG Micro Corp defines "Green" to mean Pb-Free (RoHS compatible) and free of halogen substances. If you have additional comments or questions, please contact your SGMICRO representative directly.

ABSOLUTE MAXIMUM RATINGS

Input Supply Voltage.....	-0.3V to 6V
EN Voltage.....	-0.3V to V _{IN} + 0.3V
FB/OUT, SW Voltages.....	-0.3V to V _{IN} + 0.3V
Power Dissipation, P _D @ T _A = +25°C	
TDFN-3×3-10L.....	2.2W
Package Thermal Resistance	
TDFN-3×3-10L, θ _{JA}	45°C/W
Junction Temperature.....	+150°C
Storage Temperature Range.....	-65°C to +150°C
Lead Temperature (Soldering, 10s).....	+260°C
ESD Susceptibility	
HBM.....	3000V
MM.....	200V

RECOMMENDED OPERATING CONDITIONS

Input Voltage Range.....	2.5V to 5.5V
Operating Temperature Range.....	-40°C to +85°C

OVERSTRESS CAUTION

Stresses beyond those listed in Absolute Maximum Ratings may cause permanent damage to the device. Exposure to absolute maximum rating conditions for extended periods may affect reliability. Functional operation of the device at any conditions beyond those indicated in the Recommended Operating Conditions section is not implied.

ESD SENSITIVITY CAUTION

This integrated circuit can be damaged by ESD if you don't pay attention to ESD protection. SGMICRO recommends that all integrated circuits be handled with appropriate precautions. Failure to observe proper handling and installation procedures can cause damage. ESD damage can range from subtle performance degradation to complete device failure. Precision integrated circuits may be more susceptible to damage because very small parametric changes could cause the device not to meet its published specifications.

DISCLAIMER

SG Micro Corp reserves the right to make any change in circuit design, or specifications without prior notice.

PIN CONFIGURATION

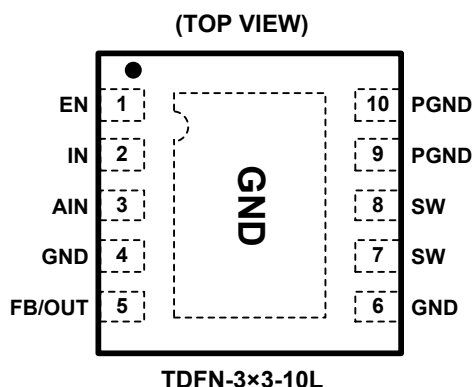

PIN DESCRIPTION

PIN	NAME	FUNCTION
1	EN	Enable Pin. The IC goes into shutdown mode when this pin is connected to ground. When connect this pin to IN, the device is enabled. Do not leave it floating and must be terminated.
2	IN	Supply Voltage Input. Strongly recommend to use a 22 μ F ceramic capacitor or greater to decouple this pin closely to GND.
3	AIN	Analog Supply Input. Provides bias for internal circuitry.
4, 6	GND	Analog Ground.
5	FB	Feedback Pin. This pin receives the feedback voltage from an external resistive divider across the output. The internal voltage divider is disabled for adjustable version. (SGM6014-ADJ)
	OUT	Output Voltage Pin. An internal resistive divider divides the output voltage down for comparison to the internal reference voltage. (SGM6014-3.3)
7, 8	SW	Switching Node Pin. Put an output inductor to this pin.
9, 10	PGND	Power Ground.
Exposed Pad	GND	Analog Ground Exposed Pad. Must be connected to GND plane.

ELECTRICAL CHARACTERISTICS

(V_{IN} = 3.6V, T_A = -40°C to +85°C, unless otherwise noted.)

PARAMETER		SYMBOL	CONDITIONS	MIN	TYP	MAX	UNITS	
Input Voltage Range		V _{IN}		2.5		5.5	V	
Regulated Output Voltage		V _{OUT}		1.2		V _{IN} ⁽¹⁾	V	
Input DC Bias Current	PWM Mode	I _Q	V _{FB} = 0.58V		300	420	μA	
	PFM Mode		Adjustable Version	V _{FB} = 0.62V		55		95
			Fixed Version	V _{FB} = 0.62V		55		110
	Shutdown		V _{IN} = 5.5V, V _{EN} = 0V		0.01	2		
Feedback Input Bias Current		I _{FB}	V _{FB} = 0.65V		0.001	1	μA	
Regulated Feedback Voltage		V _{FB}	V _{IN} = 2.5V to 5.5V, T _A = +25°C	0.587	0.6	0.616	V	
			V _{IN} = 2.5V to 5.5V, T _A = -40°C to +85°C	0.583	0.6	0.619		
Line Regulation			V _{IN} = 2.5V to 5.5V, I _{LOAD} = 350mA		0.1	0.6	%/V	
Load Regulation			I _{LOAD} = 200mA to 2000mA		0.07		%/A	
Output Voltage Accuracy	Adjustable Version		V _{IN} = 2.5V to 5.5V, I _{LOAD} = 350mA	-3.5		+3.5	%	
	Fixed Version		V _{IN} = 2.5V to 5.5V, I _{LOAD} = 350mA	-3.5		+5		
Oscillator Frequency		f _{OSC}			1.4		MHz	
Startup Time		t _S	From Enable to Output Regulation		500		μs	
Over-Temperature Shutdown Threshold		t _{SD}			150		°C	
Over-Temperature Shutdown Hysteresis		t _{HYS}			15		°C	
Peak Switch Current		I _{PK}			2.7		A	
R _{DS(ON)} of P-Channel FET		R _{DS(ON)}	V _{IN} = 3.6V		135		mΩ	
R _{DS(ON)} of N-Channel FET			V _{IN} = 3.6V		115			
EN Threshold	Logic-High Voltage	V _{EN_H}	V _{EN} Rising	1.5			V	
	Logic-Low Voltage	V _{EN_L}	V _{EN} Falling			0.4		
Enable Leakage Current		I _{EN}	V _{EN} = 0V or V _{IN}		0.01	1	μA	

NOTE:

1. The maximum output voltage is 4.4V.

TYPICAL PERFORMANCE CHARACTERISTICS

T_A = +25°C, L = 2.2μH, C_{IN} = C_{OUT} = 22μF, unless otherwise noted.

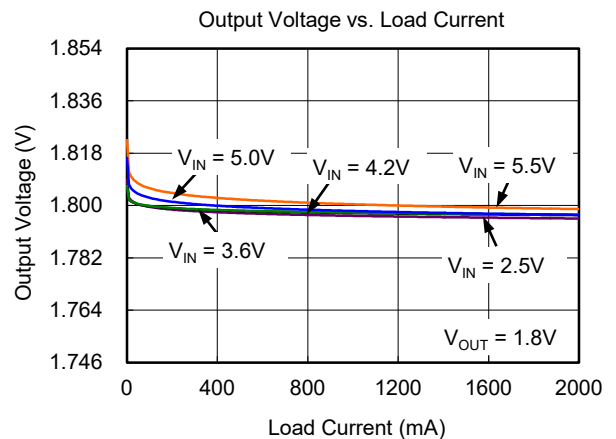
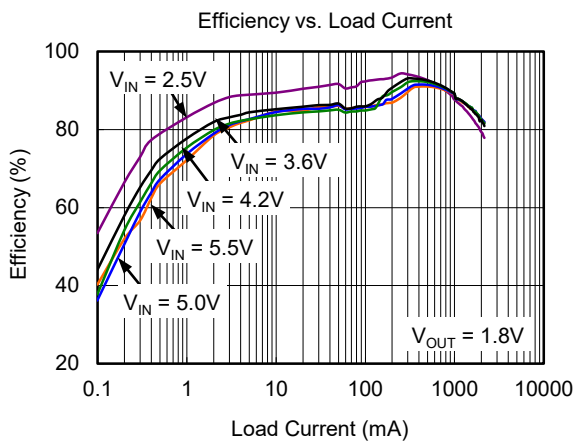
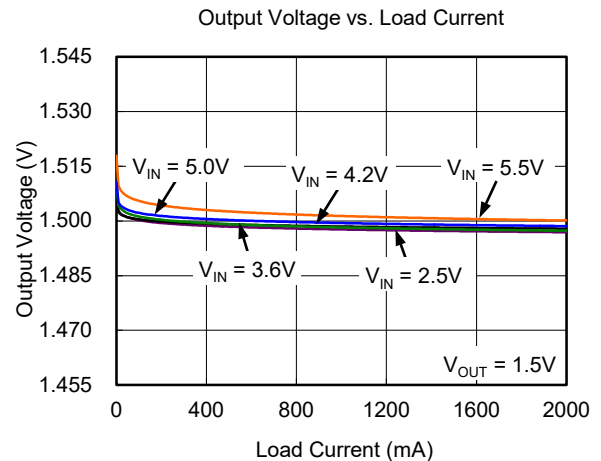
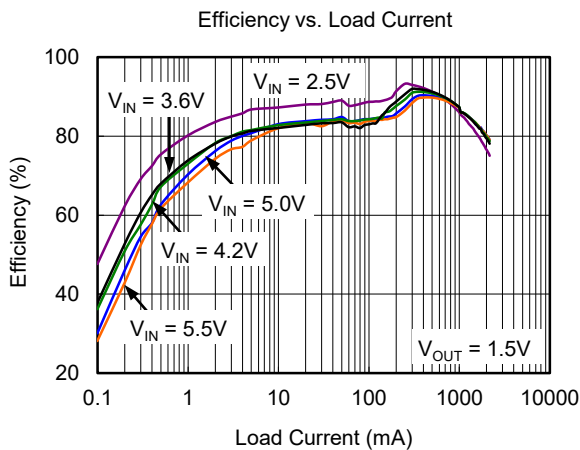
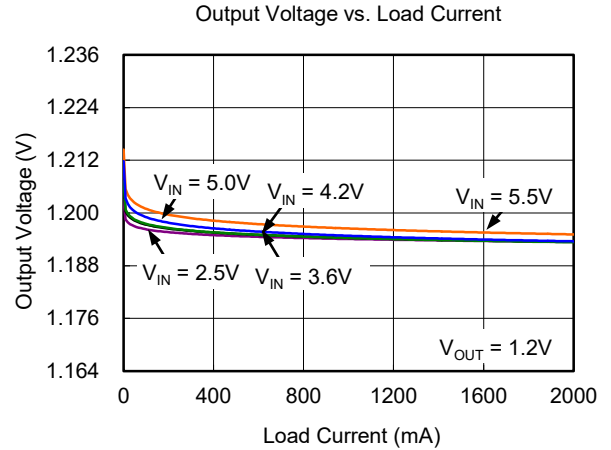
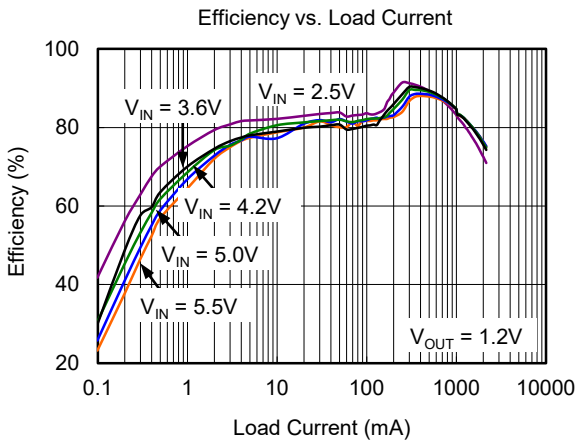

TYPICAL PERFORMANCE CHARACTERISTICS (continued)

T_A = +25°C, L = 2.2µH, C_{IN} = C_{OUT} = 22µF, unless otherwise noted.

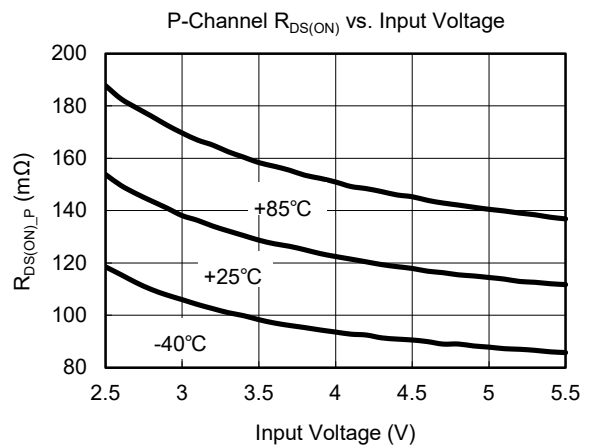
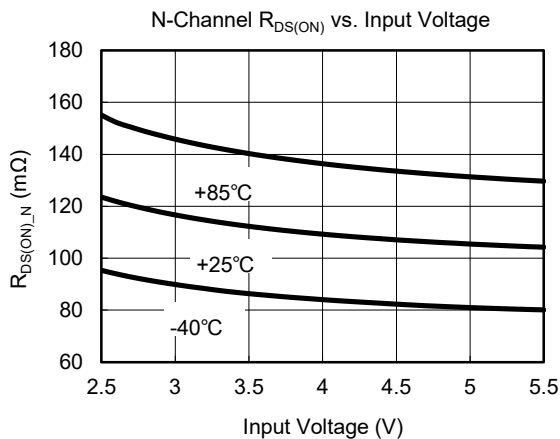
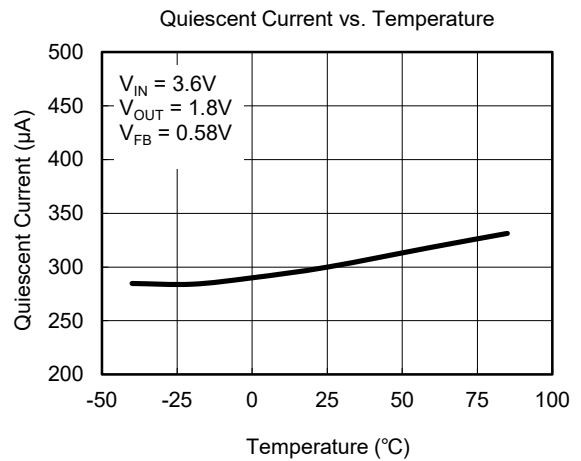
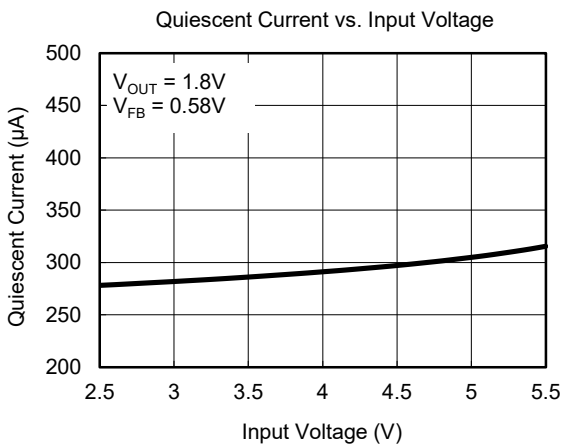
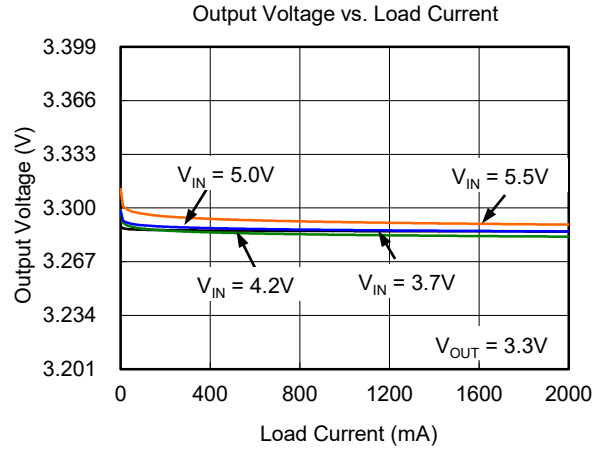
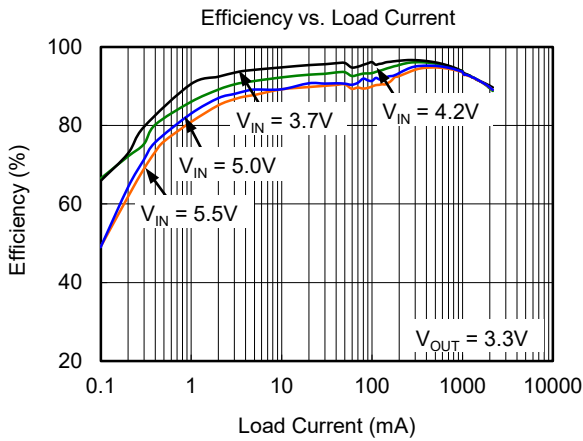

TYPICAL PERFORMANCE CHARACTERISTICS (continued)

T_A = +25°C, L = 2.2µH, C_{IN} = C_{OUT} = 22µF, unless otherwise noted.

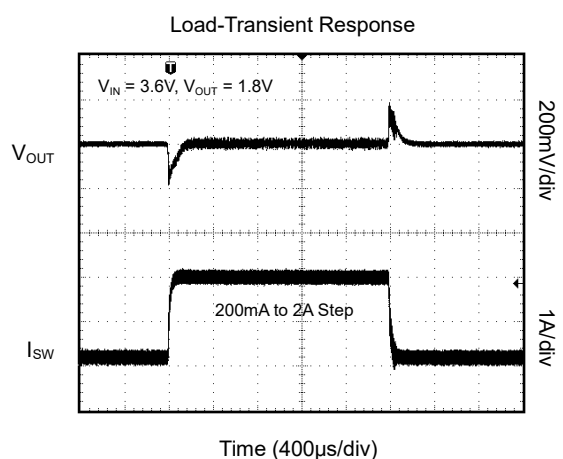
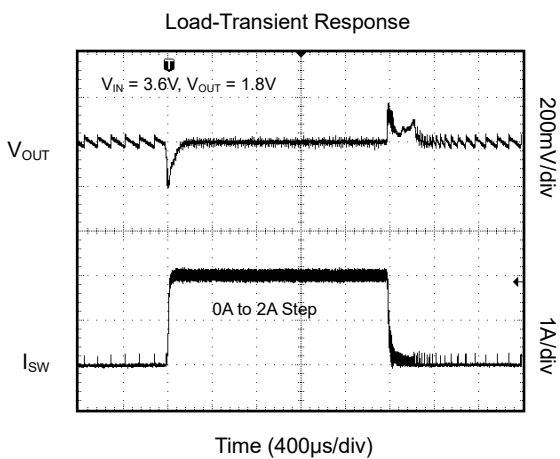
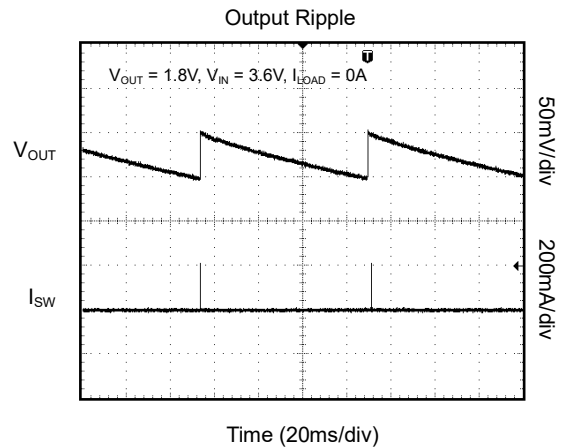
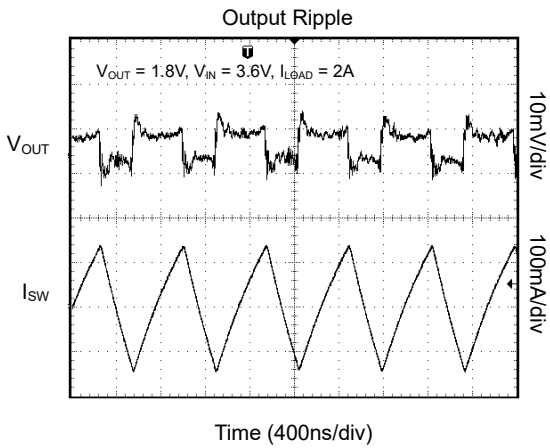
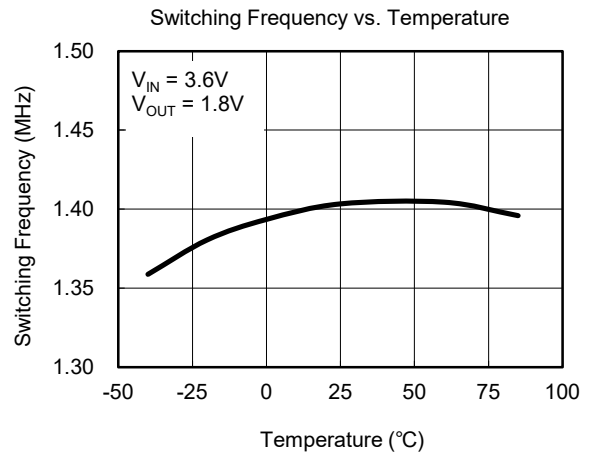
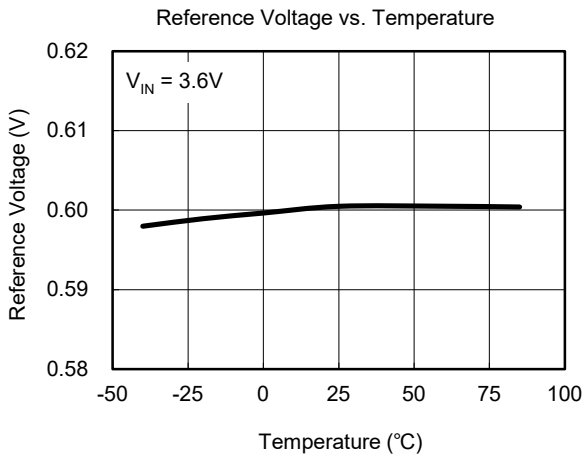

TYPICAL PERFORMANCE CHARACTERISTICS (continued)

T_A = +25°C, L = 2.2μH, C_{IN} = C_{OUT} = 22μF, unless otherwise noted.

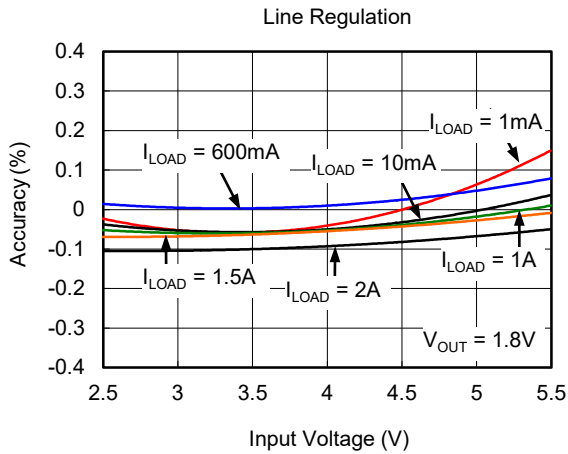
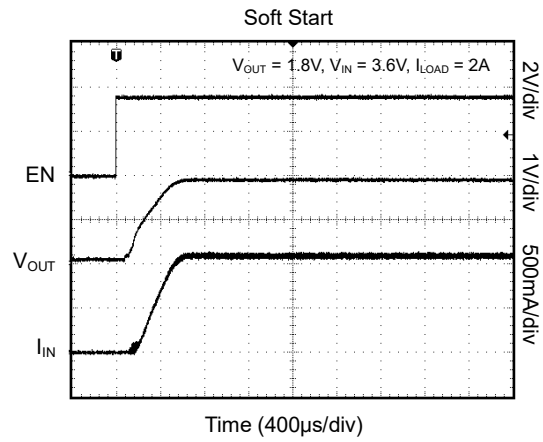
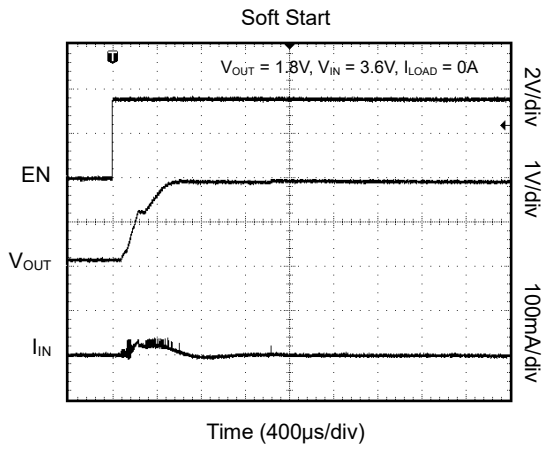

REVISION HISTORY

NOTE: Page numbers for previous revisions may differ from page numbers in the current version.

SEPTEMBER 2017 – REV.A.2 to REV.A.3

Deleted SGM6014-1.2YTD10G and SGM6014-1.8YTD10G All

AUGUST 2015 – REV.A.1 to REV.A.2

Update exposed pad function 3

NOVEMBER 2013 – REV.A to REV.A.1

Add fixed output voltage versions All

Change ESD susceptibility 2

Change electrical characteristics 4

Changes from Original (JULY 2013) to REV.A

Changed from product preview to production data All

PACKAGE OUTLINE DIMENSIONS

TDFN-3x3-10L

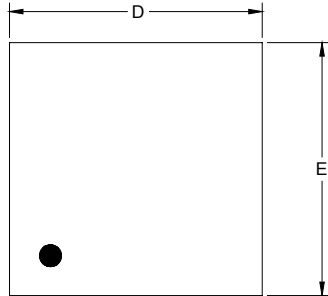

TOP VIEW

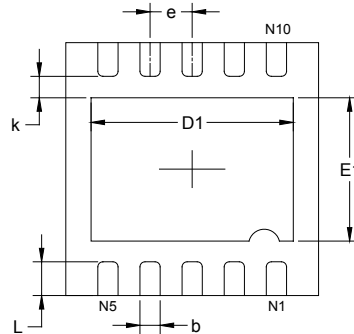

BOTTOM VIEW

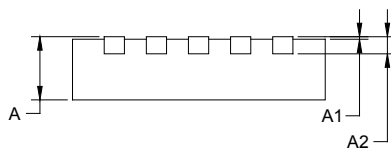

SIDE VIEW

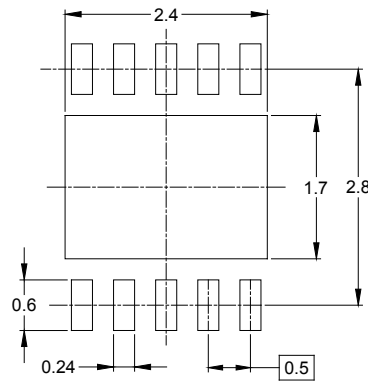

RECOMMENDED LAND PATTERN (Unit: mm)

Symbol	Dimensions In Millimeters		Dimensions In Inches	
	MIN	MAX	MIN	MAX
A	0.700	0.800	0.028	0.031
A1	0.000	0.050	0.000	0.002
A2	0.203 REF		0.008 REF	
D	2.900	3.100	0.114	0.122
D1	2.300	2.600	0.091	0.103
E	2.900	3.100	0.114	0.122
E1	1.500	1.800	0.059	0.071
k	0.200 MIN		0.008 MIN	
b	0.180	0.300	0.007	0.012
e	0.500 TYP		0.020 TYP	
L	0.300	0.500	0.012	0.020

TAPE AND REEL INFORMATION

REEL DIMENSIONS

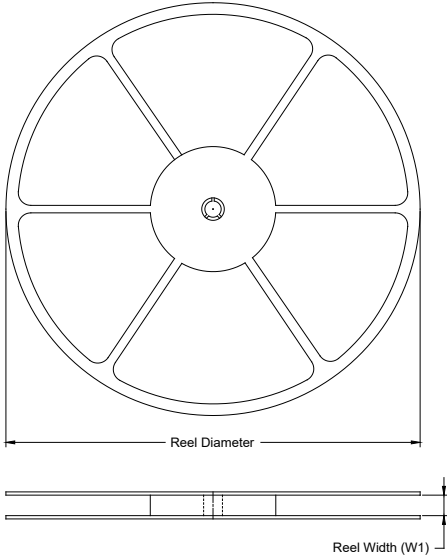

TAPE DIMENSIONS



NOTE: The picture is only for reference. Please make the object as the standard.

KEY PARAMETER LIST OF TAPE AND REEL

Package Type	Reel Diameter	Reel Width W1 (mm)	A0 (mm)	B0 (mm)	K0 (mm)	P0 (mm)	P1 (mm)	P2 (mm)	W (mm)	Pin1 Quadrant
TDFN-3×3-10L	13"	12.4	3.35	3.35	1.13	4.0	8.0	2.0	12.0	Q1

000001

PACKAGE INFORMATION

CARTON BOX DIMENSIONS



NOTE: The picture is only for reference. Please make the object as the standard.

KEY PARAMETER LIST OF CARTON BOX

Reel Type	Length (mm)	Width (mm)	Height (mm)	Pizza/Carton
13"	386	280	370	5

DD0002

单击下面可查看定价，库存，交付和生命周期等信息

[>>SGMICRO\(圣邦微电子\)](#)