

GENERAL DESCRIPTION

The SGM5532 is a dual, low noise operational amplifier, which operates on a wide supply range from 5V to 36V.

The SGM5532 offers an ultra-low noise of $5\text{nV}/\sqrt{\text{Hz}}$ with low distortion. It also features unity-gain bandwidth, high slew rate and high output current. The device has input protection diodes and provides output short-circuit protection.

The SGM5532 is available in a Green SOIC-8 package. It operates over an ambient temperature range of -40°C to $+85^{\circ}\text{C}$.

FEATURES

- **Ultra-Low Input Voltage Noise:**
 $5\text{nV}/\sqrt{\text{Hz}}$ (TYP) at 1kHz
- **Unity-Gain Bandwidth:** 8.5MHz (TYP)
- **High Slew Rate:** $18\text{V}/\mu\text{s}$ (TYP)
- **CMRR:** 140dB (TYP)
- **High Open-Loop Gain:** 140dB (TYP)
- **-40°C to $+85^{\circ}\text{C}$ Operating Temperature Range**
- **Available in a Green SOIC-8 Package**

APPLICATIONS

High-End A/V Receiving Machines
Pro Audio Mixers
Video Broadcasting
Multichannel Video Transcoders
Laptops
Embedded Computers

PACKAGE/ORDERING INFORMATION

MODEL	PACKAGE DESCRIPTION	SPECIFIED TEMPERATURE RANGE	ORDERING NUMBER	PACKAGE MARKING	PACKING OPTION
SGM5532	SOIC-8	-40°C to +85°C	SGM5532YS8G/TR	SGM 5532YS8 XXXXX	Tape and Reel, 4000

MARKING INFORMATION

NOTE: XXXXX = Date Code and Vendor Code.

XXXXX

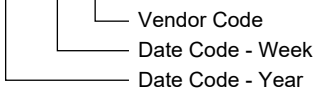

Green (RoHS & HSF): SG Micro Corp defines "Green" to mean Pb-Free (RoHS compatible) and free of halogen substances. If you have additional comments or questions, please contact your SGMICRO representative directly.

ABSOLUTE MAXIMUM RATINGS

- Supply Voltage, +V_S to -V_S..... 40V
- Input Common Mode Voltage Range
..... (-V_S) - 0.3V to (+V_S) + 0.3V
- Junction Temperature+150°C
- Storage Temperature Range..... -65°C to +150°C
- Lead Temperature (Soldering, 10s)+260°C
- ESD Susceptibility
- HBM..... 5000V
- MM..... 200V
- CDM 1000V

RECOMMENDED OPERATING CONDITIONS

- Supply Voltage, +V_S to -V_S.....5V to 36V
- Operating Temperature Range -40°C to +85°C

OVERSTRESS CAUTION

Stresses beyond those listed in Absolute Maximum Ratings may cause permanent damage to the device. Exposure to absolute maximum rating conditions for extended periods may affect reliability. Functional operation of the device at any conditions beyond those indicated in the Recommended Operating Conditions section is not implied.

ESD SENSITIVITY CAUTION

This integrated circuit can be damaged if ESD protections are not considered carefully. SGMICRO recommends that all integrated circuits be handled with appropriate precautions. Failure to observe proper handling and installation procedures

can cause damage. ESD damage can range from subtle performance degradation to complete device failure. Precision integrated circuits may be more susceptible to damage because even small parametric changes could cause the device not to meet the published specifications.

DISCLAIMER

SG Micro Corp reserves the right to make any change in circuit design, or specifications without prior notice.

PIN CONFIGURATION

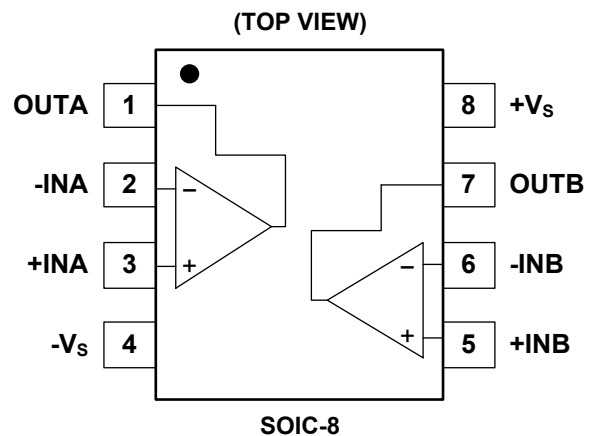

ELECTRICAL CHARACTERISTICS

(At $T_A = +25^\circ\text{C}$, Full = -40°C to $+85^\circ\text{C}$, $V_S = \pm 15\text{V}$, $R_L = 2\text{k}\Omega$ connected to 0V , unless otherwise noted.)

PARAMETER	SYMBOL	CONDITIONS	TEMP	MIN	TYP	MAX	UNITS
Input Characteristics							
Input Offset Voltage	V_{OS}	$V_{CM} = 0\text{V}$	+25°C		100	500	μV
			Full			620	
Input Offset Voltage Drift	$\Delta V_{OS}/\Delta T$		Full		0.6		$\mu\text{V}/^\circ\text{C}$
Input Bias Current	I_B	$V_{CM} = 0\text{V}$	+25°C		550	750	nA
			Full			900	
Input Offset Current	I_{OS}	$V_{CM} = 0\text{V}$	+25°C		10	70	nA
			Full			100	
Input Common Mode Voltage Range	V_{CM}		Full	-13		13	V
Common Mode Rejection Ratio	CMRR	$V_S = \pm 15\text{V}$, $-13\text{V} < V_{CM} < 13\text{V}$	+25°C	128	140		dB
			Full	124			
Open-Loop Voltage Gain	A_{OL}	$V_S = \pm 15\text{V}$, $V_{OUT} = \pm 10\text{V}$, $R_L = 2\text{k}\Omega$	+25°C	128	140		dB
			Full	120			
			+25°C	112	128		
			Full	108			
Output Characteristics							
Output Voltage Swing from Rail	V_{OUT}	$V_S = \pm 15\text{V}$, $R_L = 2\text{k}\Omega$	+25°C		150	185	mV
			Full			230	
			+25°C		550	660	
			Full			840	
Output Short-Circuit Current	I_{SC}	$V_S = \pm 15\text{V}$	+25°C	± 27	± 36		mA
Power Supply							
Operating Voltage Range	V_S		Full	5		36	V
Quiescent Current	I_Q	$I_{OUT} = 0$	+25°C		8.5	17.5	mA
			Full			18	
Power Supply Rejection Ratio	PSRR	$V_S = 5\text{V}$ to 36V	+25°C	122	138		dB
			Full	119			
Dynamic Performance							
Gain-Bandwidth Product	GBP	$f = 10\text{kHz}$			20		MHz
Slew Rate	SR				18		$\text{V}/\mu\text{s}$
Overload Recovery Time	ORT	$V_{IN} \times G = V_S$			1.2		μs
Maximum Output-Swing Bandwidth	B_{OM}	$V_S = \pm 15\text{V}$, $V_{OUT} = \pm 10\text{V}$, $R_L = 600\Omega$			280		kHz
Unity-Gain Bandwidth	B_1	$R_L = 600\Omega$			8.5		MHz
Total Harmonic Distortion + Noise	THD+N	$V_S = \pm 15\text{V}$, $V_{OUT} = 10\text{V}_{P-P}$, $f = 1\text{kHz}$, $G = +1$, $R_L = 600\Omega$			0.00005		%
Noise							
Input Voltage Noise		$f = 0.1\text{Hz}$ to 10Hz			0.3		μV_{P-P}
Input Voltage Noise Density	e_n	$f = 30\text{Hz}$			15		$\text{nV}/\sqrt{\text{Hz}}$
		$f = 1\text{kHz}$			5		
Input Current Noise Density	i_n	$f = 30\text{Hz}$			3		$\text{pA}/\sqrt{\text{Hz}}$
		$f = 1\text{kHz}$			1		

TYPICAL PERFORMANCE CHARACTERISTICS

At $T_A = +25^\circ\text{C}$, $V_S = \pm 15\text{V}$ and $R_L = 2\text{k}\Omega$, unless otherwise noted.

Large-Signal Step Response

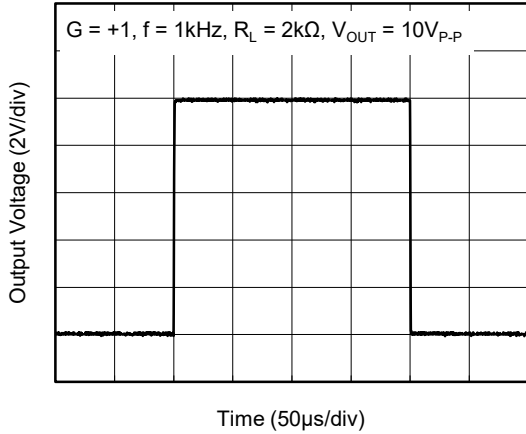

Small-Signal Step Response

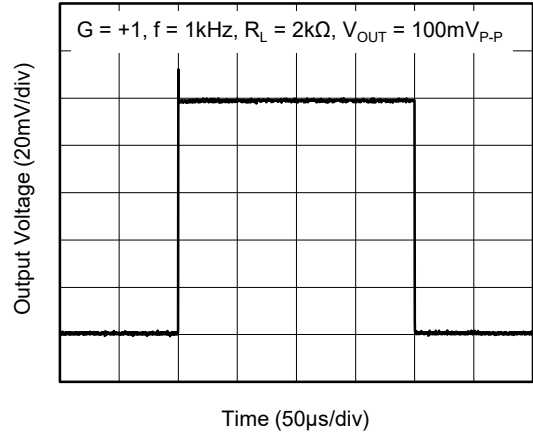

Positive Overload Recovery

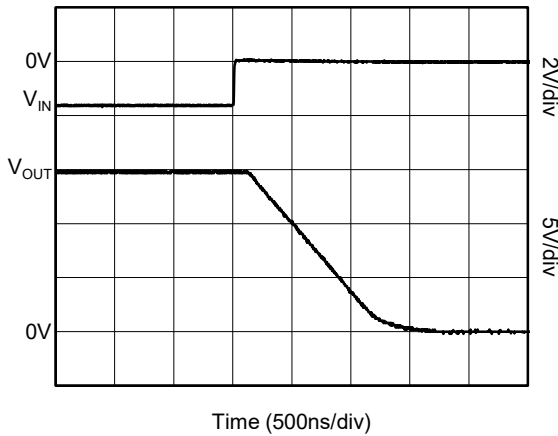

Negative Overload Recovery

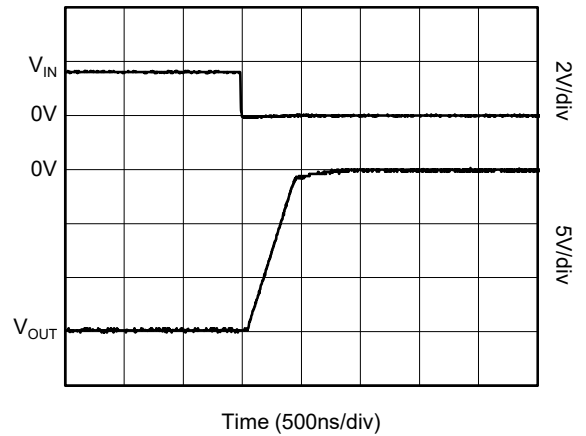

Input Offset Voltage vs. Input Common Mode Voltage

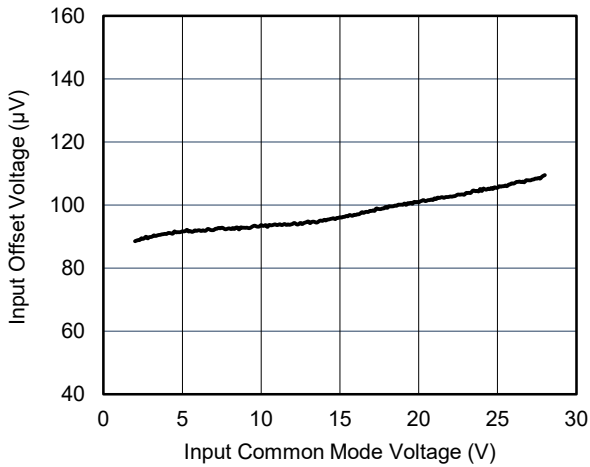

Output Voltage vs. Output Current

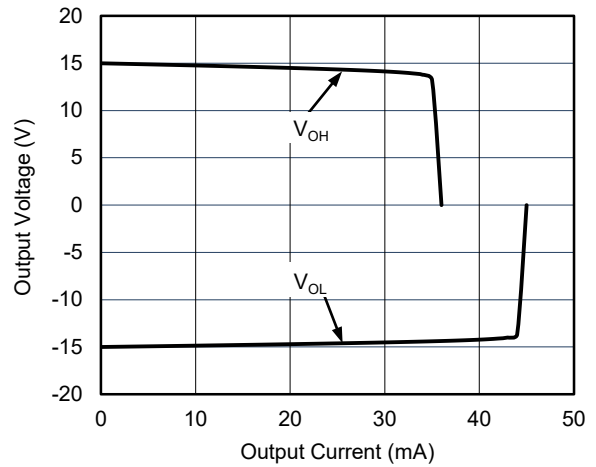

TYPICAL PERFORMANCE CHARACTERISTICS (continued)

At $T_A = +25^\circ\text{C}$, $V_S = \pm 15\text{V}$ and $R_L = 2\text{k}\Omega$, unless otherwise noted.

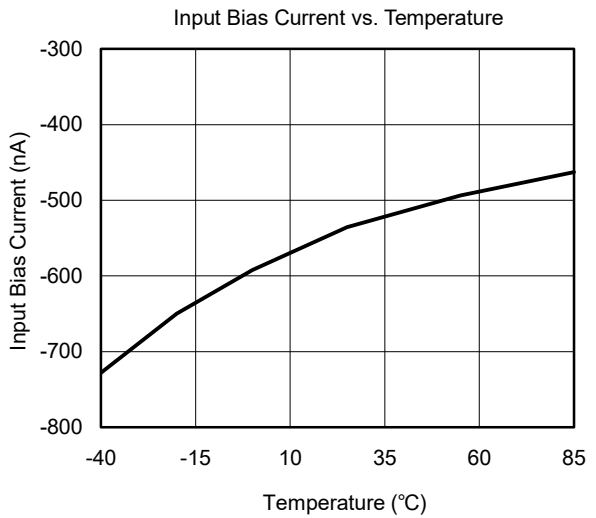
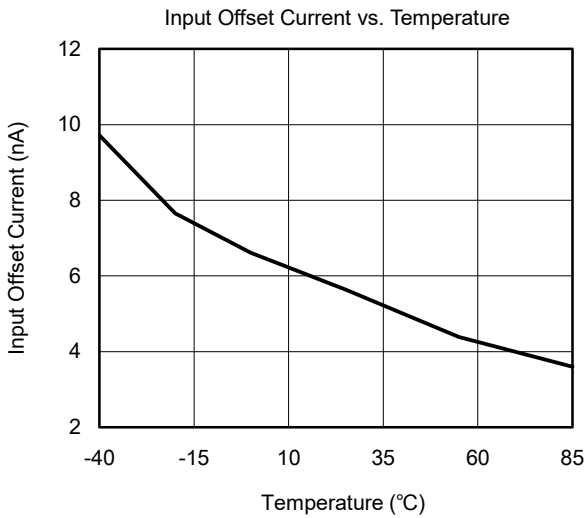
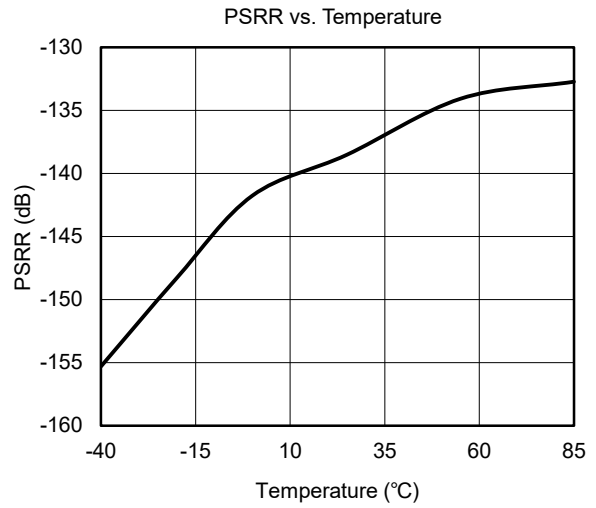
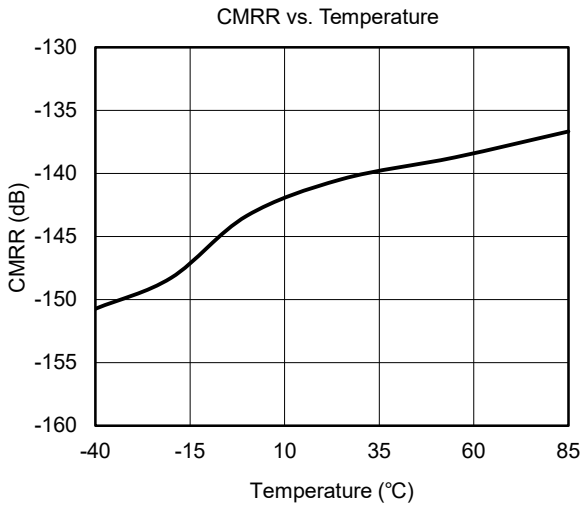
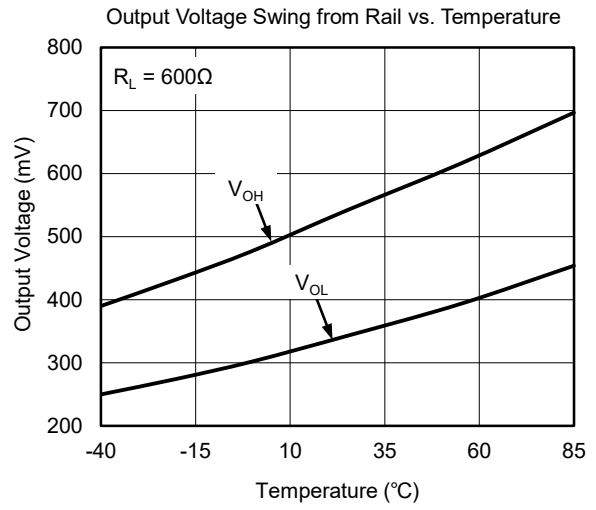
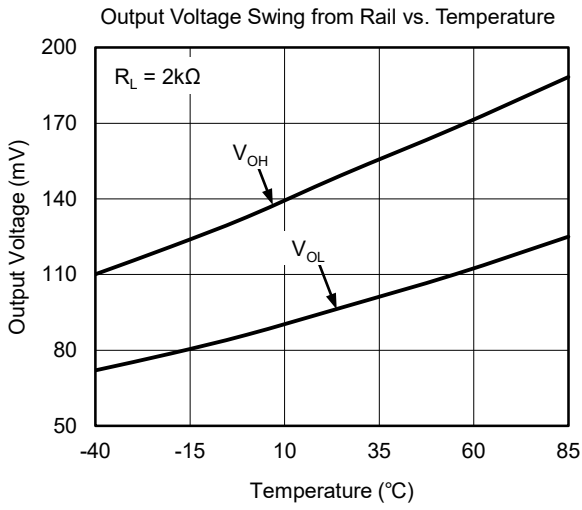

TYPICAL PERFORMANCE CHARACTERISTICS (continued)

At $T_A = +25^\circ\text{C}$, $V_S = \pm 15\text{V}$ and $R_L = 2\text{k}\Omega$, unless otherwise noted.

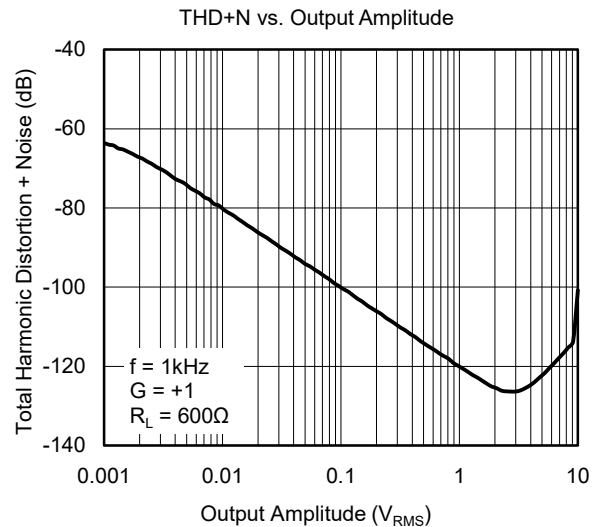
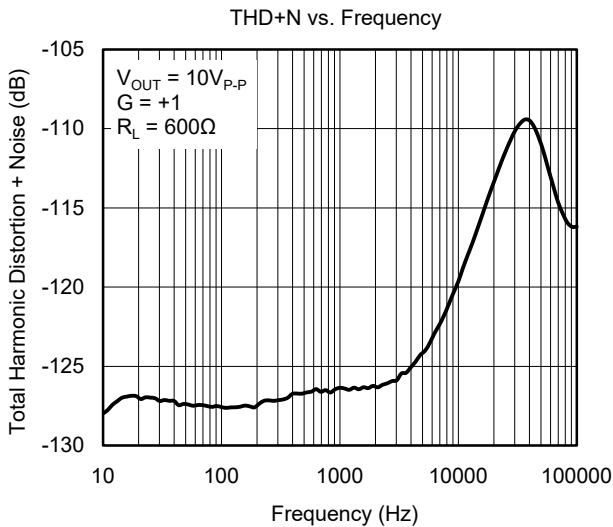
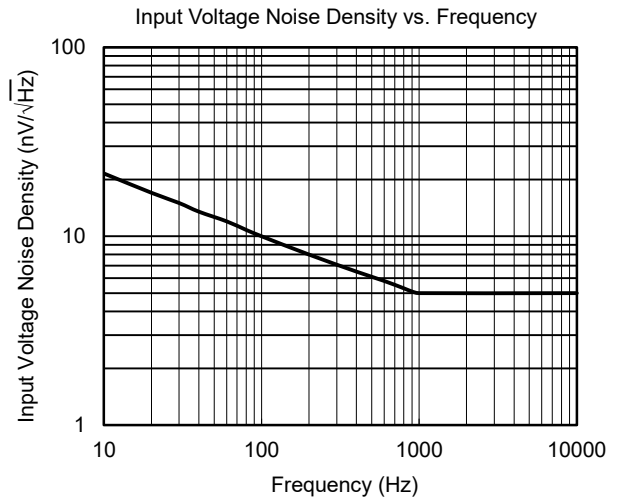
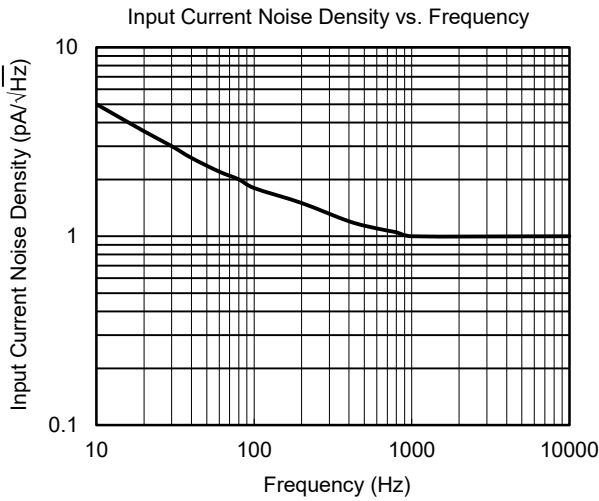
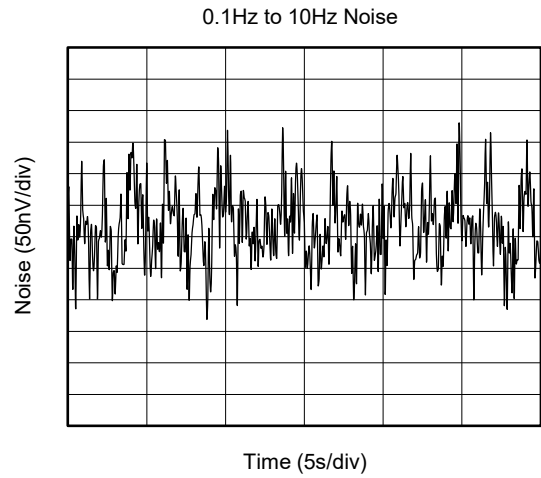
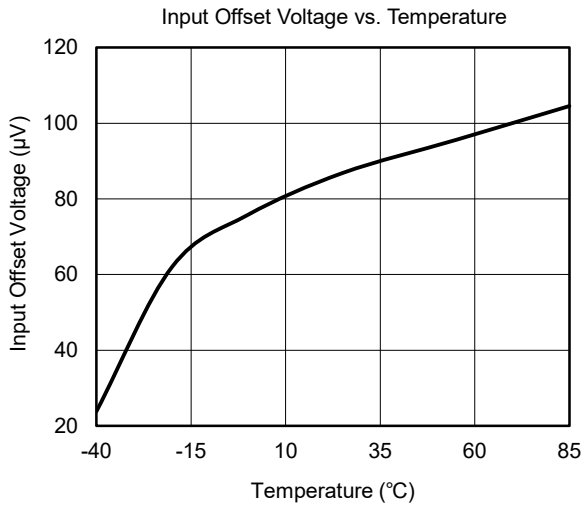

TYPICAL PERFORMANCE CHARACTERISTICS (continued)

At $T_A = +25^\circ\text{C}$, $V_S = \pm 15\text{V}$ and $R_L = 2\text{k}\Omega$, unless otherwise noted.

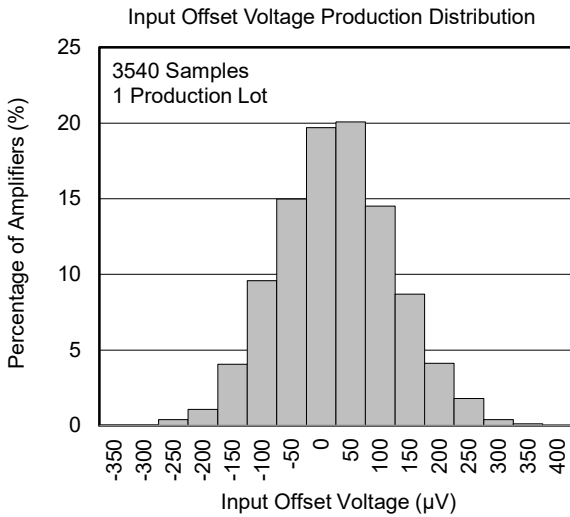
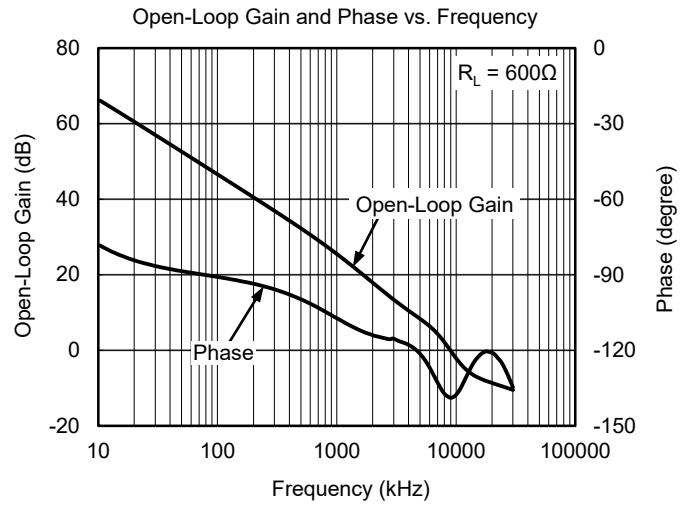
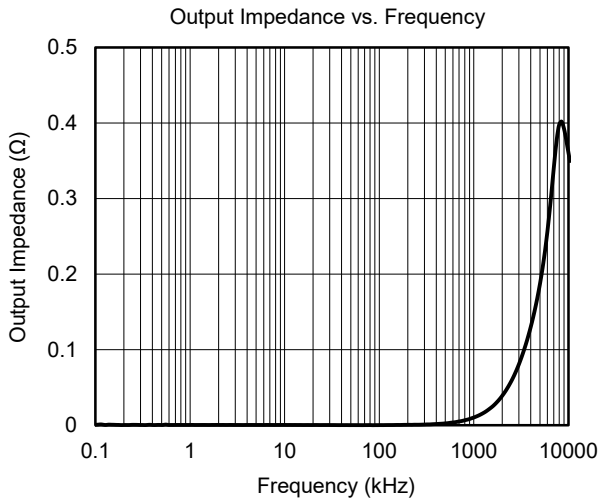

REVISION HISTORY

NOTE: Page numbers for previous revisions may differ from page numbers in the current version.

APRIL 2018 – REV.A to REV.A.1	Page
Updated Electrical Characteristics section	3

Changes from Original (DECEMBER 2017) to REV.A	Page
Changed from product preview to production data.....	All

PACKAGE OUTLINE DIMENSIONS

SOIC-8

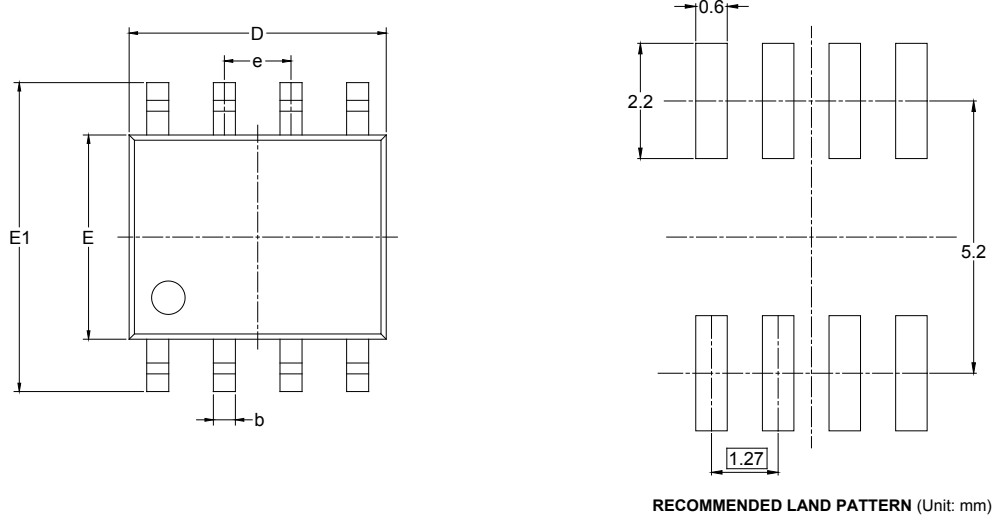

Symbol	Dimensions In Millimeters		Dimensions In Inches	
	MIN	MAX	MIN	MAX
A	1.350	1.750	0.053	0.069
A1	0.100	0.250	0.004	0.010
A2	1.350	1.550	0.053	0.061
b	0.330	0.510	0.013	0.020
c	0.170	0.250	0.006	0.010
D	4.700	5.100	0.185	0.200
E	3.800	4.000	0.150	0.157
E1	5.800	6.200	0.228	0.244
e	1.27 BSC		0.050 BSC	
L	0.400	1.270	0.016	0.050
θ	0°	8°	0°	8°

PACKAGE INFORMATION

TAPE AND REEL INFORMATION

REEL DIMENSIONS

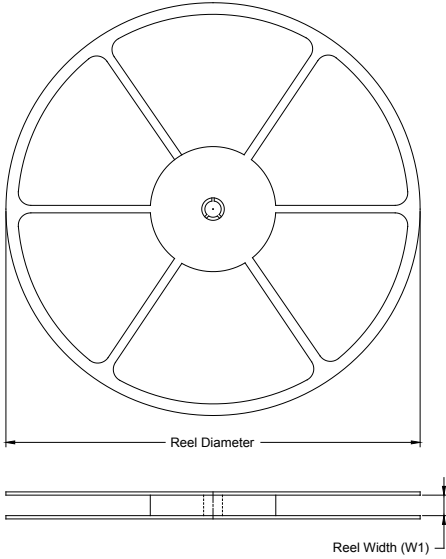

TAPE DIMENSIONS

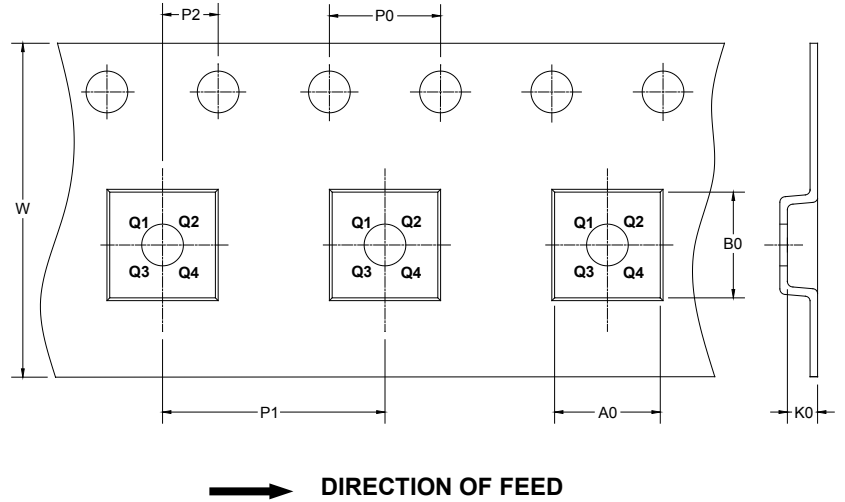

NOTE: The picture is only for reference. Please make the object as the standard.

KEY PARAMETER LIST OF TAPE AND REEL

Package Type	Reel Diameter	Reel Width W1 (mm)	A0 (mm)	B0 (mm)	K0 (mm)	P0 (mm)	P1 (mm)	P2 (mm)	W (mm)	Pin1 Quadrant
SOIC-8	13"	12.4	6.40	5.40	2.10	4.0	8.0	2.0	12.0	Q1

000001

PACKAGE INFORMATION

CARTON BOX DIMENSIONS



NOTE: The picture is only for reference. Please make the object as the standard.

KEY PARAMETER LIST OF CARTON BOX

Reel Type	Length (mm)	Width (mm)	Height (mm)	Pizza/Carton
13"	386	280	370	5

DD0002

单击下面可查看定价，库存，交付和生命周期等信息

[>>SGMICRO\(圣邦微电子\)](#)