



SGM2019 Low Power, Low Dropout, RF Linear Regulator

GENERAL DESCRIPTION

The SGM2019 is a low power, low noise and low dropout voltage RF linear regulator. It is capable of supplying 300mA output current with typical dropout voltage of only 270mV. The operating input voltage range is from 2.5V to 5.5V. The fixed output voltage range is from 1.2V to 3.3V and the adjustable output voltage range is from 1.2V to 5.0V.

Other features include logic-controlled shutdown mode, output current limit and thermal shutdown protection.

The SGM2019 is suitable for application which needs low noise and low power supply, such as MP3 players, palmtop computers, etc. Fixed or adjustable output voltage versions are provided.

The SGM2019 is available in Green SOT-23-5 and SC70-5 packages. It operates over an operating temperature range of -40°C to +85°C.

APPLICATIONS

- Modems
- MP3 Players
- Cellular Telephones
- PCMCIA Cards
- Palmtop Computers
- Portable Electronics

FEATURES

- Operating Input Voltage Range: 2.5V to 5.5V
- Fixed Output Voltages: 1.2V, 1.5V, 1.8V, 2.5V, 2.6V, 2.8V, 2.85V, 3.0V, 3.3V
- Adjustable Output Voltage Range: 1.2V to 5.0V
- Output Voltage Accuracy: $\pm 2.5\%$ at +25°C
- Low Output Noise: 30 μ V_{RMS} (TYP)
- Low Dropout Voltage: 270mV (TYP) at 300mA
- High PSRR: 74dB (TYP) at 1kHz
- Shutdown Current: 0.01 μ A (TYP)
- Thermal Shutdown Protection
- Output Current Limit
- -40°C to +85°C Operating Temperature Range
- Available in Green SC70-5 and SOT-23-5 Packages

PRODUCT NAME STRUCTURE

SGM2019 - X X X G / TR

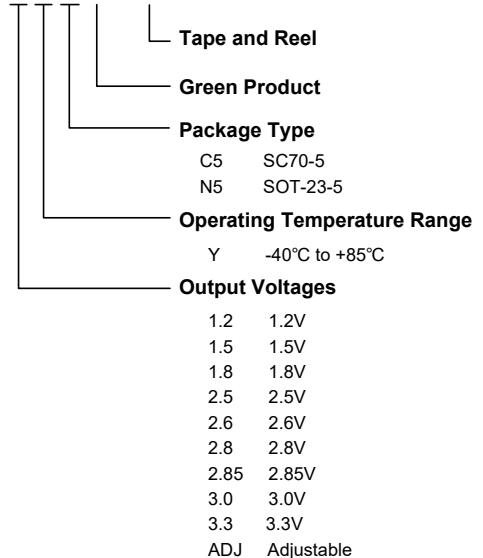

PACKAGE/ORDERING INFORMATION

MODEL	PACKAGE DESCRIPTION	SPECIFIED TEMPERATURE RANGE	ORDERING NUMBER	PACKAGE MARKING	PACKING OPTION
SGM2019-1.2	SOT-23-5	-40°C to +85°C	SGM2019-1.2YN5G/TR	YJ12	Tape and Reel, 3000
SGM2019-1.2	SC70-5	-40°C to +85°C	SGM2019-1.2YC5G/TR	YJ12	Tape and Reel, 3000
SGM2019-1.5	SOT-23-5	-40°C to +85°C	SGM2019-1.5YN5G/TR	YJ15	Tape and Reel, 3000
SGM2019-1.5	SC70-5	-40°C to +85°C	SGM2019-1.5YC5G/TR	YJ15	Tape and Reel, 3000
SGM2019-1.8	SOT-23-5	-40°C to +85°C	SGM2019-1.8YN5G/TR	YJ18	Tape and Reel, 3000
SGM2019-1.8	SC70-5	-40°C to +85°C	SGM2019-1.8YC5G/TR	YJ18	Tape and Reel, 3000
SGM2019-2.5	SOT-23-5	-40°C to +85°C	SGM2019-2.5YN5G/TR	YJ25	Tape and Reel, 3000
SGM2019-2.5	SC70-5	-40°C to +85°C	SGM2019-2.5YC5G/TR	YJ25	Tape and Reel, 3000
SGM2019-2.6	SOT-23-5	-40°C to +85°C	SGM2019-2.6YN5G/TR	YJ26	Tape and Reel, 3000
SGM2019-2.6	SC70-5	-40°C to +85°C	SGM2019-2.6YC5G/TR	YJ26	Tape and Reel, 3000
SGM2019-2.8	SOT-23-5	-40°C to +85°C	SGM2019-2.8YN5G/TR	YJ28	Tape and Reel, 3000
SGM2019-2.8	SC70-5	-40°C to +85°C	SGM2019-2.8YC5G/TR	YJ28	Tape and Reel, 3000
SGM2019-2.85	SOT-23-5	-40°C to +85°C	SGM2019-2.85YN5G/TR	YJ2J	Tape and Reel, 3000
SGM2019-2.85	SC70-5	-40°C to +85°C	SGM2019-2.85YC5G/TR	YJ2J	Tape and Reel, 3000
SGM2019-3.0	SOT-23-5	-40°C to +85°C	SGM2019-3.0YN5G/TR	YJ30	Tape and Reel, 3000
SGM2019-3.0	SC70-5	-40°C to +85°C	SGM2019-3.0YC5G/TR	YJ30	Tape and Reel, 3000
SGM2019-3.3	SOT-23-5	-40°C to +85°C	SGM2019-3.3YN5G/TR	YJ33	Tape and Reel, 3000
SGM2019-3.3	SC70-5	-40°C to +85°C	SGM2019-3.3YC5G/TR	YJ33	Tape and Reel, 3000
SGM2019-ADJ	SOT-23-5	-40°C to +85°C	SGM2019-ADJYN5G/TR	YJAA	Tape and Reel, 3000
SGM2019-ADJ	SC70-5	-40°C to +85°C	SGM2019-ADJYC5G/TR	YJAA	Tape and Reel, 3000

Green (RoHS & HSF): SG Micro Corp defines "Green" to mean Pb-Free (RoHS compatible) and free of halogen substances. If you have additional comments or questions, please contact your SGMICRO representative directly.

ABSOLUTE MAXIMUM RATINGS

IN to GND	-0.3V to 6V
Output Short-Circuit Duration	Infinite
EN to GND.....	-0.3V to V_{IN}
OUT, BP/FB to GND.....	-0.3V to ($V_{IN} + 0.3V$)
Power Dissipation, P_D @ $T_A = +25^\circ C$	
SOT-23-5.....	0.4W
SC70-5.....	0.3W
Package Thermal Resistance	
SOT-23-5, θ_{JA}	260°C/W
SC70-5, θ_{JA}	330°C/W
Junction Temperature.....	+150°C
Storage Temperature Range	-65°C to +150°C
Lead Temperature (Soldering, 10s).....	+260°C
ESD Susceptibility	
HBM.....	4000V
MM.....	400V

RECOMMENDED OPERATING CONDITIONS

Operating Temperature Range	-40°C to +85°C
-----------------------------------	----------------

OVERSTRESS CAUTION

Stresses beyond those listed in Absolute Maximum Ratings may cause permanent damage to the device. Exposure to absolute maximum rating conditions for extended periods may affect reliability. Functional operation of the device at any conditions beyond those indicated in the Recommended Operating Conditions section is not implied.

ESD SENSITIVITY CAUTION

This integrated circuit can be damaged if ESD protections are not considered carefully. SGMICRO recommends that all integrated circuits be handled with appropriate precautions. Failure to observe proper handling and installation procedures can cause damage. ESD damage can range from subtle performance degradation to complete device failure. Precision integrated circuits may be more susceptible to damage because even small parametric changes could cause the device not to meet the published specifications.

DISCLAIMER

SG Micro Corp reserves the right to make any change in circuit design, or specifications without prior notice.

PIN CONFIGURATION

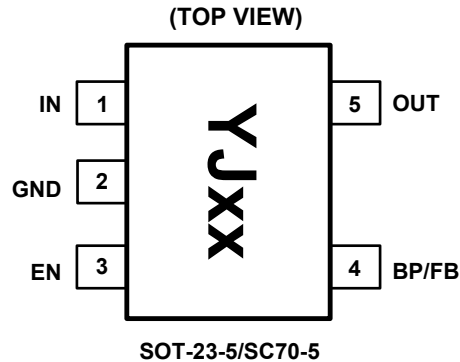

NOTES:

1. The location of pin 1 on the YJxx is determined by orienting the package marking as shown.
2. "xx" is the output voltage code. (For Example: when the output voltage is 1.8V, it is expressed as 18.)

PIN DESCRIPTION

PIN	NAME	FUNCTION
SC70-5/ SOT-23-5		
1	IN	Input Voltage Supply Pin. It is recommended to use a 1 μ F or larger ceramic capacitor from IN pin to ground.
2	GND	Ground.
3	EN	Enable Pin. Drive EN high to turn on the regulator. Drive EN low to turn off the regulator.
4	BP	Reference-Noise Bypass Pin (fixed voltage version only). Bypass with an external capacitor C_{BP} can reduce output noise to very low level.
	FB	Feedback Voltage Input Pin (adjustable voltage version only). Connect this pin to the external resistor divider to adjust the output voltage.
5	OUT	Regulator Output Pin. It is recommended to use 1 μ F or larger ceramic output capacitor from OUT pin to ground. The capacitor should be located very close to this pin.

ELECTRICAL CHARACTERISTICS

(V_{IN} = V_{OUT (NOMINAL)} + 0.5V⁽¹⁾, Full = -40°C to +85°C, unless otherwise noted.)

PARAMETER	SYMBOL	CONDITIONS	TEMP	MIN	TYP	MAX	UNITS
Input Voltage	V _{IN}		+25°C	2.5		5.5	V
Output Voltage Accuracy ⁽¹⁾		I _{OUT} = 0.1mA	+25°C	-2.5		2.5	%
Maximum Output Current ⁽¹⁾		SOT-23-5	+25°C	300			mA
		V _{OUT} = 1.2V, 1.5V, 1.8V, SC70-5		150			
		V _{OUT} > 2V, SC70-5		250			
Current Limit ⁽¹⁾	I _{LIM}		+25°C	310	500		mA
Ground Pin Current	I _Q	No load, EN = 2V	+25°C		100	200	μA
Dropout Voltage ⁽²⁾		I _{OUT} = 1mA	+25°C		0.9		mV
		I _{OUT} = 300mA			270	400	
Line Regulation ⁽¹⁾	ΔV _{LNR}	V _{IN} = 2.5V or (V _{OUT} + 0.5V) to 5.5V, I _{OUT} = 1mA	+25°C		0.02	0.05	%/V
Load Regulation	ΔV _{LDR}	I _{OUT} = 0.1mA to 300mA, C _{OUT} = 1μF, V _{OUT} > 2V	+25°C		0.002	0.005	%/mA
		I _{OUT} = 0.1mA to 300mA, C _{OUT} = 1μF, V _{OUT} ≤ 2V			0.004	0.008	
Output Voltage Noise	e _n	f = 10Hz to 100kHz, C _{BP} = 0.01μF, C _{OUT} = 10μF	+25°C		30		μV _{RMS}
Power Supply Rejection Ratio	PSRR	C _{BP} = 0.1μF, I _{OUT} = 50mA, C _{OUT} = 1μF, V _{IN} = V _{OUT} + 1V	f = 217Hz	+25°C		77	dB
			f = 1kHz	+25°C		74	dB
SHUTDOWN⁽³⁾							
EN Input Threshold	V _{IH}	V _{IN} = 2.5V to 5.5V, V _{EN} = -0.3V to V _{IN}	Full	1.5			V
	V _{IL}		Full			0.3	
EN Input Bias Current	I _{B(SHDN)}	EN = 0V or EN = 5.5V	+25°C		0.01	1	μA
			Full		0.01		
Shutdown Supply Current	I _{Q(SHDN)}	EN = 0.4V	Full		0.01		μA
Shutdown Exit Delay ⁽⁴⁾		C _{BP} = 0.01μF, C _{OUT} = 1μF, No Load	+25°C		30		μs
THERMAL PROTECTION							
Thermal Shutdown Temperature	T _{SHDN}				150		°C
Thermal Shutdown Hysteresis	ΔT _{SHDN}				15		°C

NOTES:

- V_{IN} = V_{OUT (NOMINAL)} + 0.5V or 2.5V, whichever is greater.
- The dropout voltage is defined as V_{IN} - V_{OUT}, when V_{OUT} is 100mV below the value of V_{OUT} for V_{IN} = V_{OUT} + 0.5V. (Only applicable for V_{OUT} = +2.5V to +5.0V.)
- V_{EN} = -0.3V to V_{IN}
- Time needed for V_{OUT} to reach 90% of final value.

TYPICAL PERFORMANCE CHARACTERISTICS

$V_{IN} = V_{OUT (NOMINAL)} + 0.5V$ or $2.5V$ (whichever is greater), $C_{IN} = 1\mu F$, $C_{OUT} = 1\mu F$, $C_{BP} = 0.01\mu F$, $T_A = +25^\circ C$, unless otherwise noted.

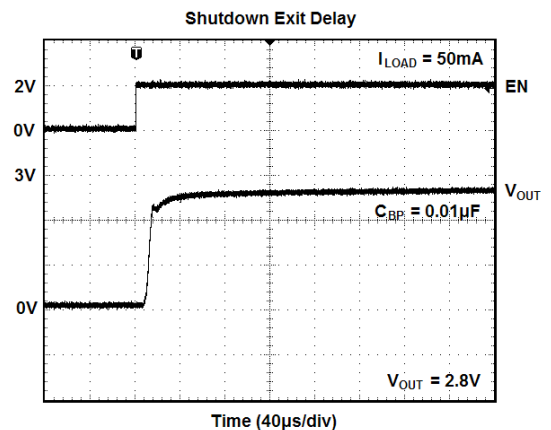
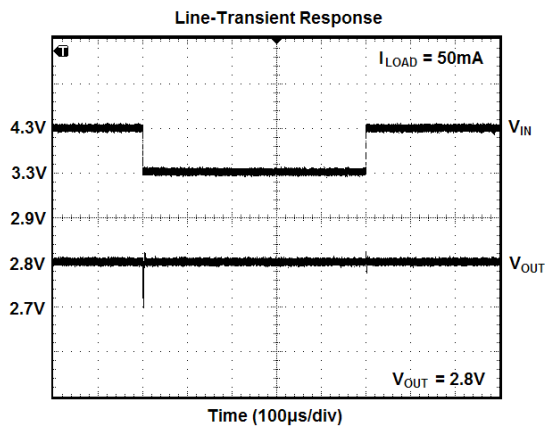
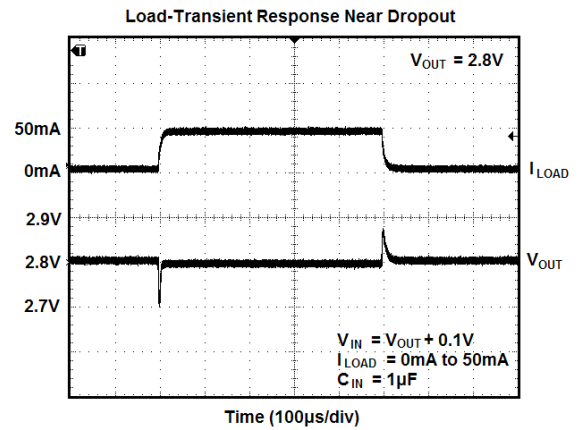
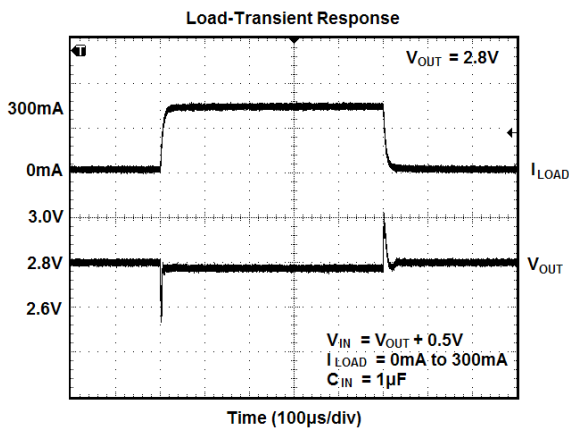
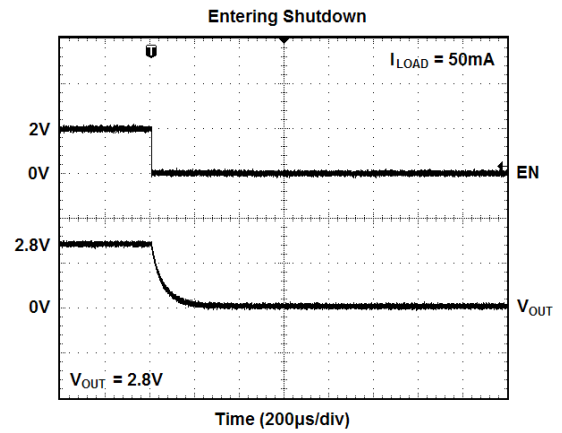
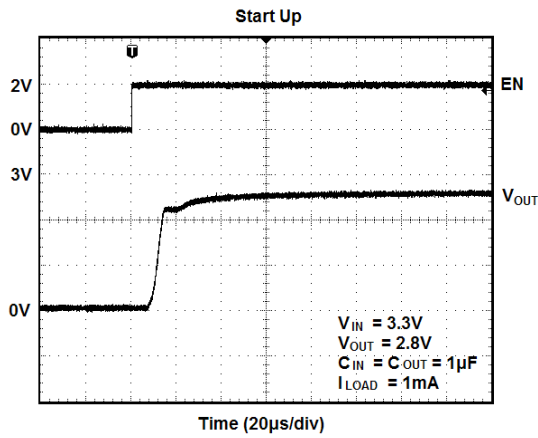

TYPICAL PERFORMANCE CHARACTERISTICS (continued)

$V_{IN} = V_{OUT (NOMINAL)} + 0.5V$ or $2.5V$ (whichever is greater), $C_{IN} = 1\mu F$, $C_{OUT} = 1\mu F$, $C_{BP} = 0.01\mu F$, $T_A = +25^\circ C$, unless otherwise noted.

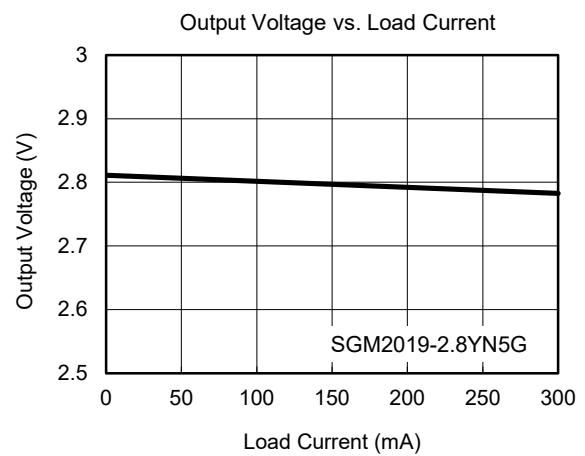
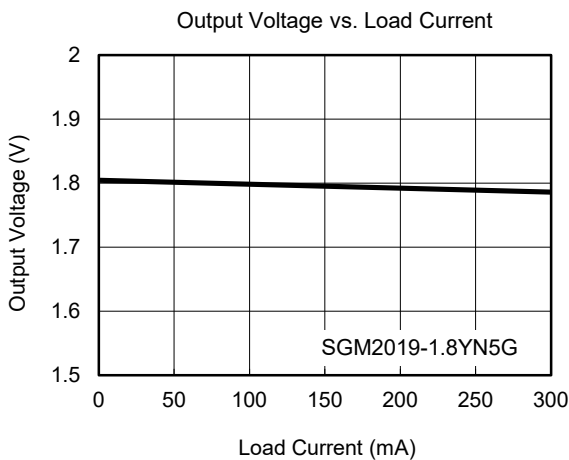
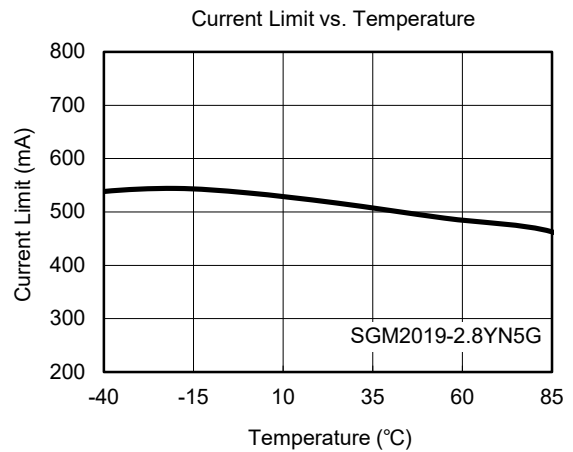
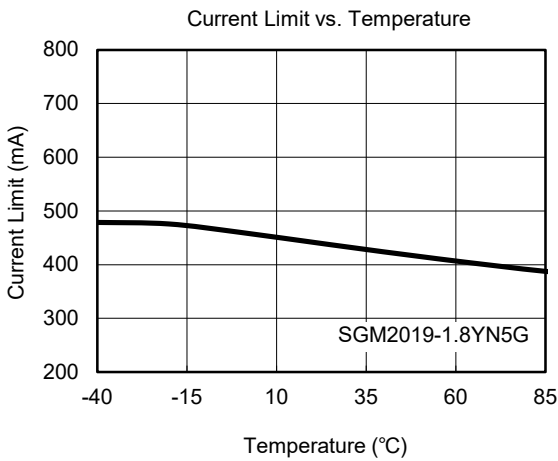
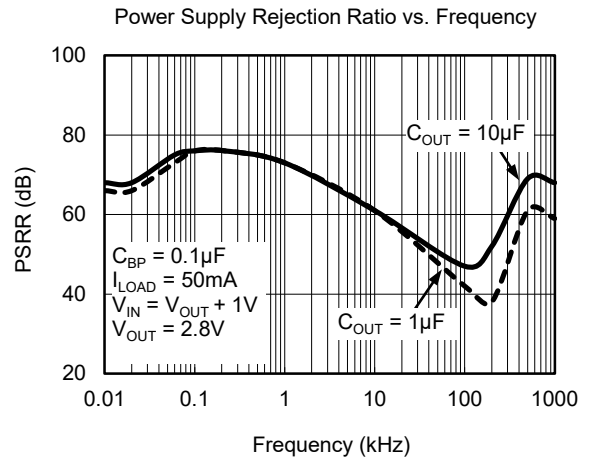
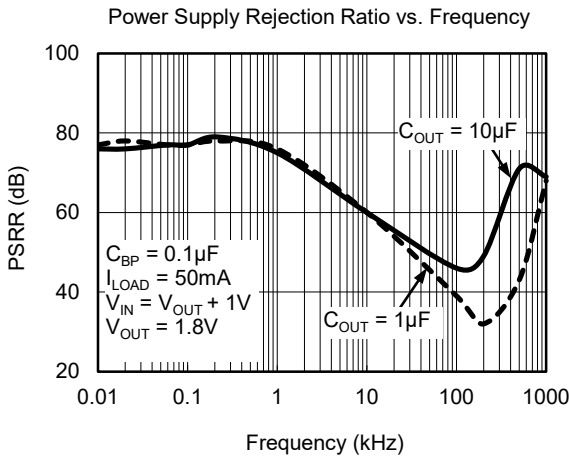

TYPICAL PERFORMANCE CHARACTERISTICS (continued)

$V_{IN} = V_{OUT (NOMINAL)} + 0.5V$ or $2.5V$ (whichever is greater), $C_{IN} = 1\mu F$, $C_{OUT} = 1\mu F$, $C_{BP} = 0.01\mu F$, $T_A = +25^\circ C$, unless otherwise noted.

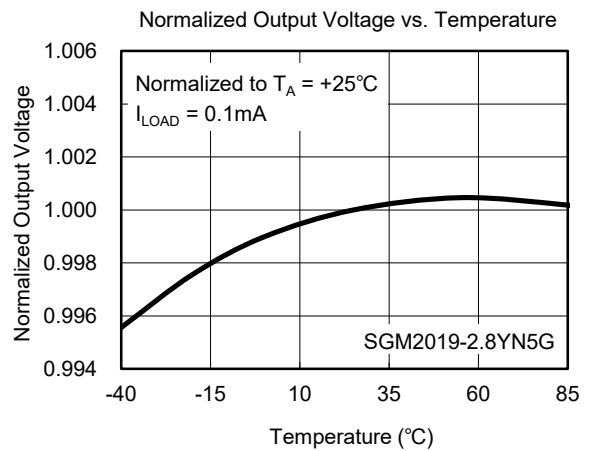
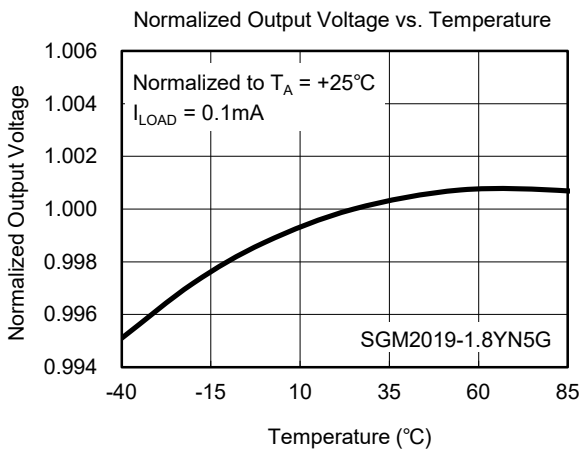
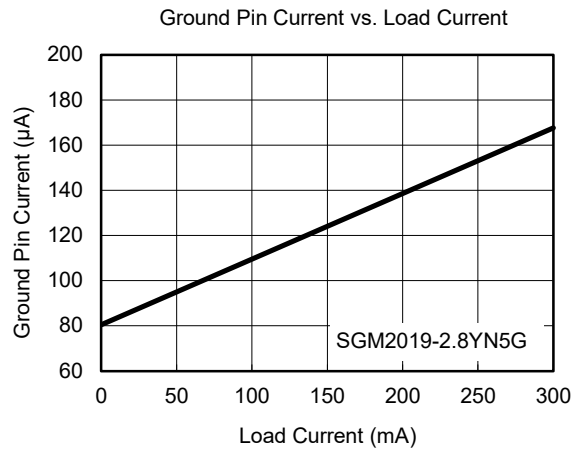
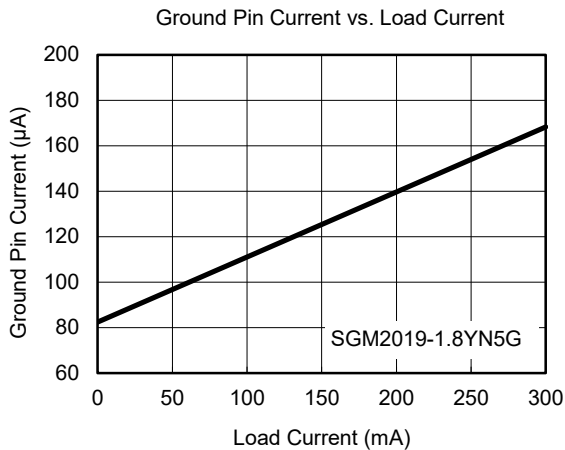
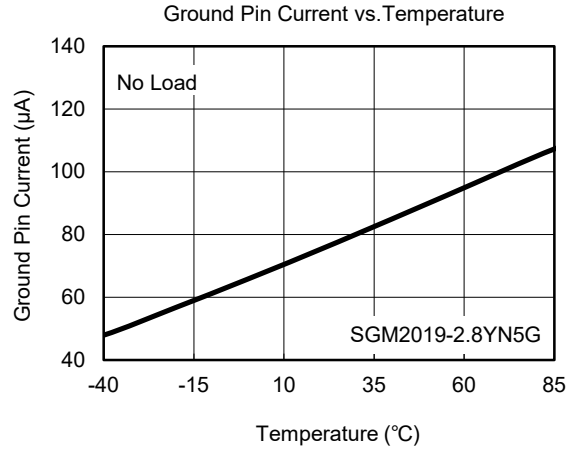
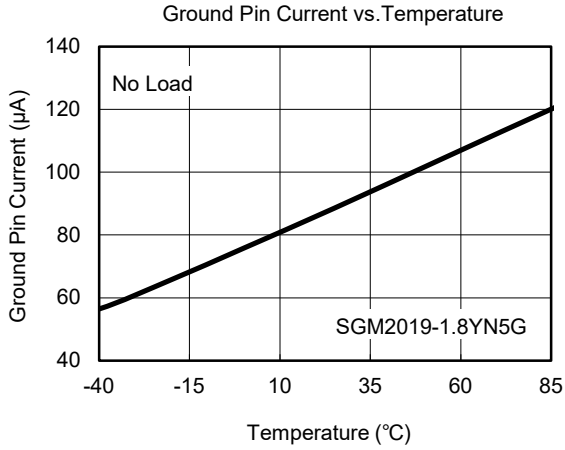

TYPICAL PERFORMANCE CHARACTERISTICS (continued)

$V_{IN} = V_{OUT (NOMINAL)} + 0.5V$ or $2.5V$ (whichever is greater), $C_{IN} = 1\mu F$, $C_{OUT} = 1\mu F$, $C_{BP} = 0.01\mu F$, $T_A = +25^\circ C$, unless otherwise noted.

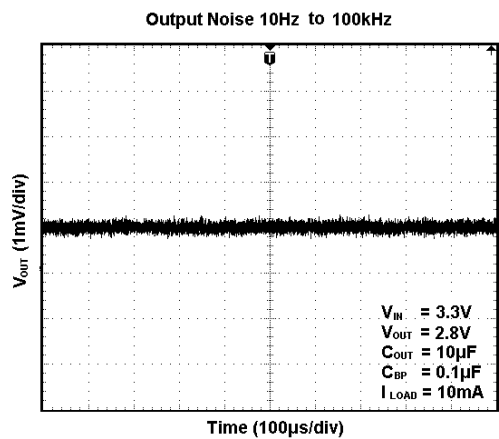
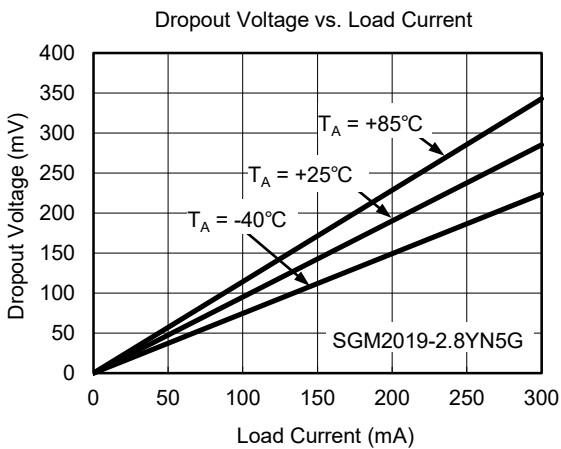
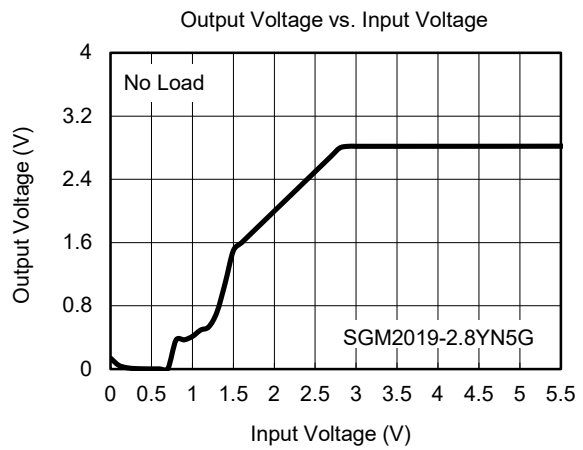
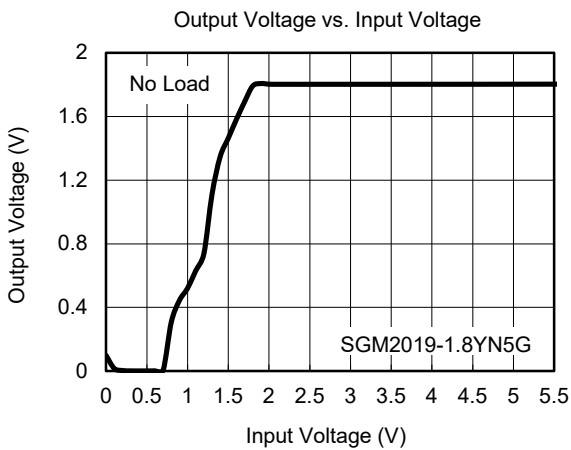
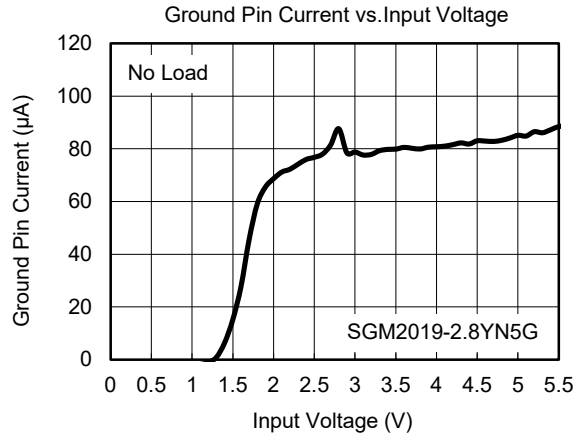
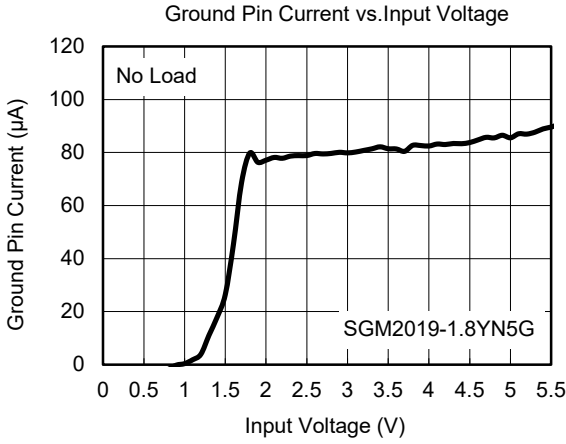

TYPICAL PERFORMANCE CHARACTERISTICS (continued)

$V_{IN} = V_{OUT (NOMINAL)} + 0.5V$ or $2.5V$ (whichever is greater), $C_{IN} = 1\mu F$, $C_{OUT} = 1\mu F$, $C_{BP} = 0.01\mu F$, $T_A = +25^\circ C$, unless otherwise noted.

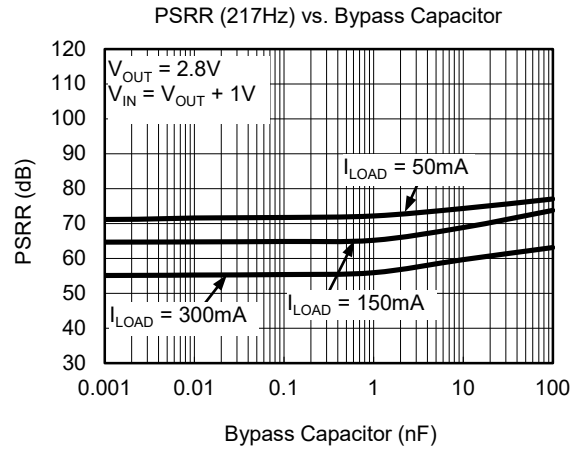
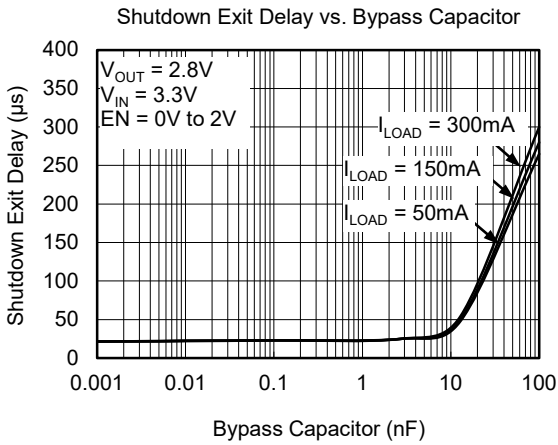

TYPICAL APPLICATION CIRCUITS

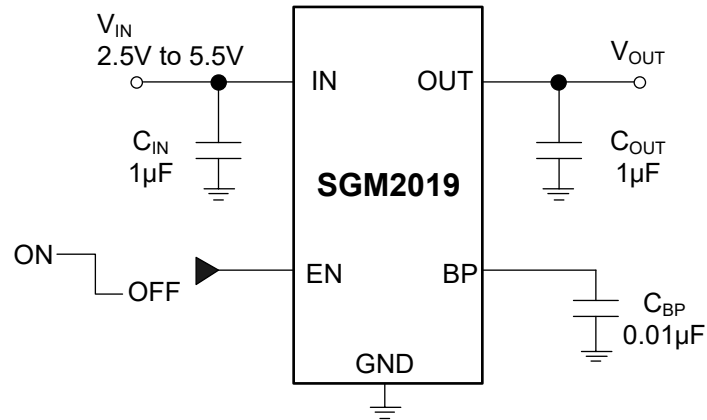

C _{BP} (nF)	Shutdown Exit Delay (µs) V _{OUT} = 2.8V, V _{IN} = 3.3V, EN = 0V to 2V			PSRR (dB) at 217Hz V _{OUT} = 2.8V, V _{IN} = V _{OUT} + 1V		
	I _{LOAD} = 50mA	I _{LOAD} = 150mA	I _{LOAD} = 300mA	I _{LOAD} = 50mA	I _{LOAD} = 150mA	I _{LOAD} = 300mA
None	21.5	21.5	21	71.1	64.4	55.0
0.001	21.5	21.5	22	71.1	64.6	55.1
0.01	22	22.5	22.5	71.6	64.7	55.2
0.1	22.5	23	23	71.7	64.8	55.4
1	25	27	28.5	72.1	65.2	55.9
10	30	35	39	74.3	68.8	59.6
100	265	280	300	77.0	73.7	63.1

TYPICAL APPLICATION CIRCUITS (continued)

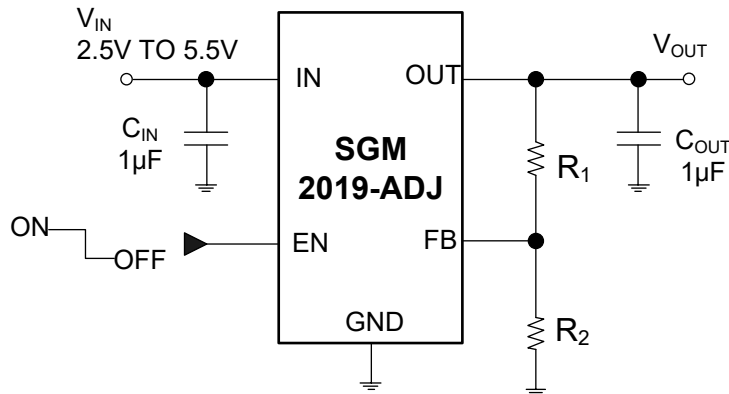

Standard 1% Resistor Values for Common Output Voltages of Adjustable Voltage Version

V _{OUT} (V)	R ₁ (kΩ)	R ₂ (kΩ)
1.2	0	63.4
1.5	10.5	42.2
1.8	34	63.4
2.8	84.5	63.4
3.0	63.4	42.2
3.3	73.2	42.2
3.6	84.5	42.2
4.2	105	42.2

NOTE: $V_{OUT} = (R_1 + R_2) / R_2 \times 1.207$

REVISION HISTORY

NOTE: Page numbers for previous revisions may differ from page numbers in the current version.

APRIL 2016 – REV.C to REV.C.1	Page
Changed the Normalized Output Voltage vs. Temperature curves	8
MAY 2012 – REV.B.4 to REV.C	Page
Added SGM2019-2.6YC5G version	All

PACKAGE OUTLINE DIMENSIONS

SC70-5

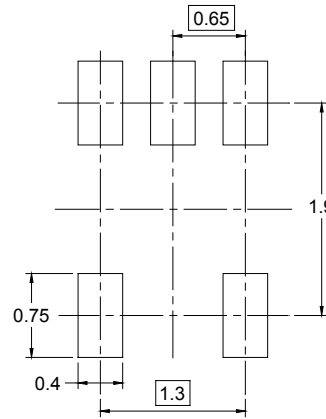
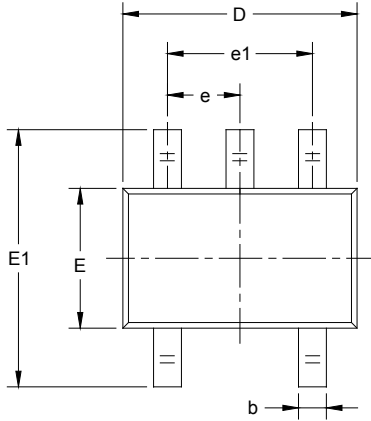

RECOMMENDED LAND PATTERN (Unit: mm)

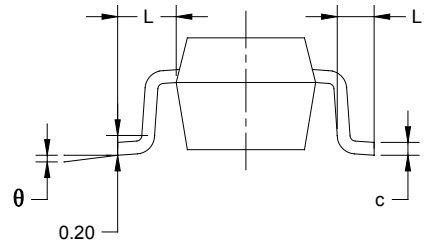
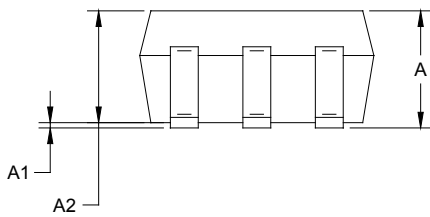

Symbol	Dimensions In Millimeters		Dimensions In Inches	
	MIN	MAX	MIN	MAX
A	0.900	1.100	0.035	0.043
A1	0.000	0.100	0.000	0.004
A2	0.900	1.000	0.035	0.039
b	0.150	0.350	0.006	0.014
c	0.080	0.150	0.003	0.006
D	2.000	2.200	0.079	0.087
E	1.150	1.350	0.045	0.053
E1	2.150	2.450	0.085	0.096
e	0.65 TYP		0.026 TYP	
e1	1.300 BSC		0.051 BSC	
L	0.525 REF		0.021 REF	
L1	0.260	0.460	0.010	0.018
θ	0°	8°	0°	8°

PACKAGE INFORMATION

PACKAGE OUTLINE DIMENSIONS

SOT-23-5

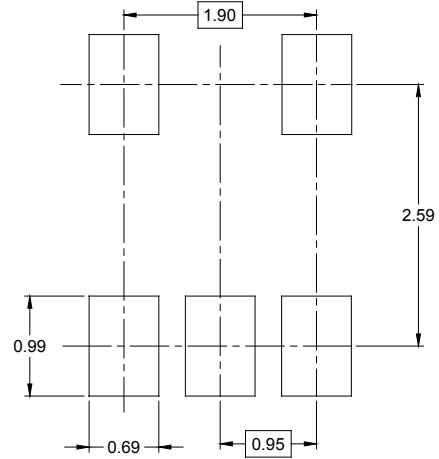
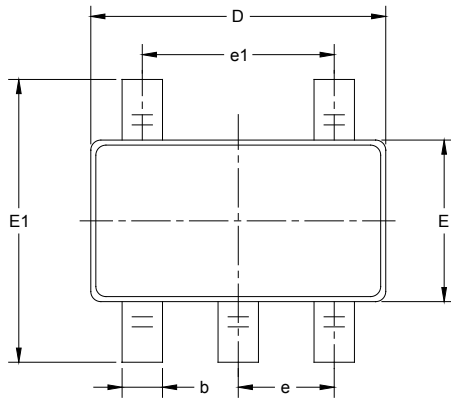

RECOMMENDED LAND PATTERN (Unit: mm)

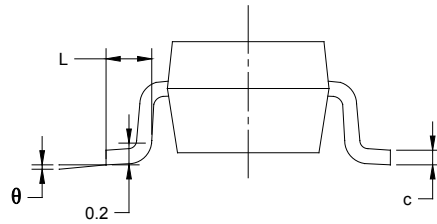
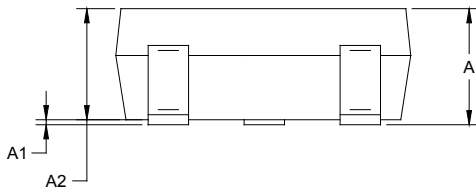

Symbol	Dimensions In Millimeters		Dimensions In Inches	
	MIN	MAX	MIN	MAX
A	1.050	1.250	0.041	0.049
A1	0.000	0.100	0.000	0.004
A2	1.050	1.150	0.041	0.045
b	0.300	0.500	0.012	0.020
c	0.100	0.200	0.004	0.008
D	2.820	3.020	0.111	0.119
E	1.500	1.700	0.059	0.067
E1	2.650	2.950	0.104	0.116
e	0.950 BSC		0.037 BSC	
e1	1.900 BSC		0.075 BSC	
L	0.300	0.600	0.012	0.024
θ	0°	8°	0°	8°

PACKAGE INFORMATION

TAPE AND REEL INFORMATION

REEL DIMENSIONS



TAPE DIMENSIONS



NOTE: The picture is only for reference. Please make the object as the standard.

KEY PARAMETER LIST OF TAPE AND REEL

Package Type	Reel Diameter	Reel Width W1 (mm)	A0 (mm)	B0 (mm)	K0 (mm)	P0 (mm)	P1 (mm)	P2 (mm)	W (mm)	Pin1 Quadrant
SC70-5	7"	9.5	2.25	2.55	1.20	4.0	4.0	2.0	8.0	Q3
SOT-23-5	7"	9.5	3.20	3.20	1.40	4.0	4.0	2.0	8.0	Q3

DD0001

PACKAGE INFORMATION

CARTON BOX DIMENSIONS



NOTE: The picture is only for reference. Please make the object as the standard.

KEY PARAMETER LIST OF CARTON BOX

Reel Type	Length (mm)	Width (mm)	Height (mm)	Pizza/Carton
7" (Option)	368	227	224	8
7"	442	410	224	18

DD0002

单击下面可查看定价，库存，交付和生命周期等信息

[>>SGMICRO\(圣邦微电子\)](#)