

GENERAL DESCRIPTION

The SGM6021 family is a 200mA, 1.4MHz synchronous buck DC/DC converter with 400nA ultra-low quiescent current, which is ideal for powering special needs of ultra-low power applications and long battery life.

The SGM6021 operation voltage range is from 1.8V to 5.5V, allowing the use of a regulated 5V input. The output regulator levels are programmed through VS pin and can be programmed for 4 different voltages, making it ideal for designing device with limited power budget calculation.

The SGM6021 delivers an output current of 200mA with a peak inductor current of 430mA. Besides, the SGM6021 series has UVLO function. It is disabled when the voltage on VIN reaches the UVLO condition. The SGM6021's UVLO level is continuously monitored.

Only inductor, C_{IN} and C_{OUT} capacitors are needed as external components to make a buck DC/DC converter solution. The SGM6021 is available in a Green UTDFN-1.5x2-6L package. It is rated over the -40°C to +85°C temperature range.

TYPICAL APPLICATION

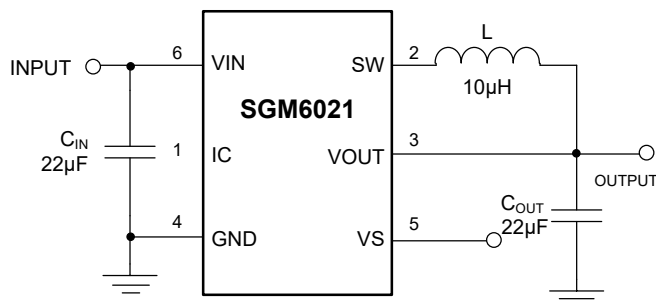

Figure 1. Typical Application Circuit

FEATURES

- High Efficiency at Low Output Currents:
Up to 90% with I_{OUT} = 0.1mA
- Ultra-Low Power Buck Converters
- 200mA Maximum Output Current
- Output Voltage Programmable in Operation
- 1.8V to 5.5V Input Voltage Range
- 400nA (TYP) Quiescent Current
- 100% Duty Cycle (Pass Mode)
- Available in a Green UTDFN-1.5x2-6L Package
- -40°C to +85°C Operating Temperature Range

APPLICATIONS

- Energy Harvest Devices
- Ultra-Low Power Applications
- Low-Power Wireless Monitoring
- Backup Power Supply Circuits
- 2-Cell and 3-Cell Alkaline-Powered Systems
- Portable Game Consoles
- Wearable Devices
- Thermal Electric Generator Harvesting
- Wireless Sensor Networks
- Smart Building Controls
- Environmental Monitoring

SELECTABLE MODEL

MODEL	I _{OUT} (mA)	V _{OUT} (V)	V1 (V)	V2 (V)	V3 (V)
SGM6021-1	200	1.25	1.20	1.10	1.02
SGM6021-2	200	3.3	3.0	2.7	2.4
SGM6021-3	200	3.0	2.5	2.0	1.8
SGM6021-4	200	2.4	1.8	1.5	1.3

400nA Ultra-Low Power, Buck Converter with 200mA Output Current

SGM6021

PACKAGE/ORDERING INFORMATION

MODEL	PACKAGE DESCRIPTION	SPECIFIED TEMPERATURE RANGE	ORDERING NUMBER	PACKAGE MARKING	PACKING OPTION
SGM6021-1	UTDFN-1.5×2-6L	-40°C to +85°C	SGM6021-1YUDT6G/TR	G90 XXX	Tape and Reel, 3000
SGM6021-2	UTDFN-1.5×2-6L	-40°C to +85°C	SGM6021-2YUDT6G/TR	GFD XXX	Tape and Reel, 3000
SGM6021-3	UTDFN-1.5×2-6L	-40°C to +85°C	SGM6021-3YUDT6G/TR	GFE XXX	Tape and Reel, 3000
SGM6021-4	UTDFN-1.5×2-6L	-40°C to +85°C	SGM6021-4YUDT6G/TR	GFF XXX	Tape and Reel, 3000

MARKING INFORMATION

NOTE: XXX = Date Code.

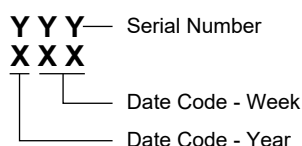

Green (RoHS & HSF): SG Micro Corp defines "Green" to mean Pb-Free (RoHS compatible) and free of halogen substances. If you have additional comments or questions, please contact your SGMICRO representative directly.

ABSOLUTE MAXIMUM RATINGS

Input Voltage Range on VIN, VS, VOUT, SW
-0.3V to 6V
 Peak Currents VIN, VOUT 510mA
 Junction Temperature +150°C
 Storage Temperature Range..... -65°C to +150°C
 Lead Temperature (Soldering, 10s) +260°C
 ESD Susceptibility
 HBM..... 7000V
 MM..... 400V
 CDM 1000V

RECOMMENDED OPERATING CONDITIONS

Input Voltage Range 1.8V to 5.5V
 Input Capacitance, CIN22µF (MIN)
 Output Capacitance, COUT 10µF (MIN), 22µF (TYP)
 Inductance, L 10µH (MIN)
 Operating Junction Temperature Range -40°C to +125°C
 Operating Ambient Temperature Range..... -40°C to +85°C

OVERSTRESS CAUTION

Stresses beyond those listed in Absolute Maximum Ratings may cause permanent damage to the device. Exposure to absolute maximum rating conditions for extended periods may affect reliability. Functional operation of the device at any conditions beyond those indicated in the Recommended Operating Conditions section is not implied.

ESD SENSITIVITY CAUTION

This integrated circuit can be damaged if ESD protections are not considered carefully. SGMICRO recommends that all integrated circuits be handled with appropriate precautions. Failure to observe proper handling and installation procedures can cause damage. ESD damage can range from subtle performance degradation to complete device failure. Precision integrated circuits may be more susceptible to damage because even small parametric changes could cause the device not to meet the published specifications.

DISCLAIMER

SG Micro Corp reserves the right to make any change in circuit design, or specifications without prior notice.

PIN CONFIGURATION

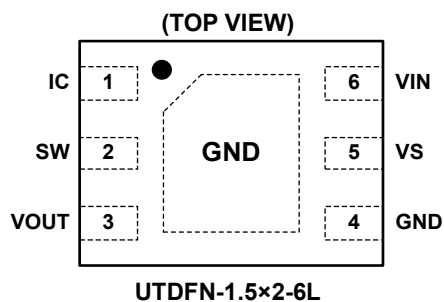

PIN DESCRIPTION

PIN	NAME	FUNCTION
1	IC	For Internal Connection.
2	SW	Switching Node. Connect to output inductor.
3	VOUT	Buck Regulator Output.
4	GND	Ground. Power and IC ground. All signals are referenced to this pin.
5	VS	Programming Regulator Output Voltage Input. Pull this pin up for period $> (t_{BLANK} + t_{SS})$ to start from shutdown state to output a default voltage or a programmable voltage, and pull this pin down for period $> t_{STOP}$ to select the default voltage or shut down its operation. This pin internally ties to a bias that is slightly higher than logic low threshold unless in shutdown state, which keeps it stay as logic high even when the external control IO is in Hi-Z status.
6	VIN	Input Voltage. Connect to input power source.
Exposed Pad	GND	Connect to GND.

ELECTRICAL CHARACTERISTICS(V_{IN} = 3.6V, V_{OUT} = 1.25V, typical values are at T_A = +25°C. Full = -40°C to +85°C, unless otherwise noted.)

PARAMETER	SYMBOL	CONDITIONS	TEMP	MIN	TYP	MAX	UNITS
QUIESCENT CURRENT							
Buck Enabled State	I _Q	V _{IN} = 1.8V, no load, no switching	+25°C		400	700	nA
OUTPUT							
Output Accuracy			+25°C	-2		2	%
			Full	-3		3	
Output Line Regulation		V _{IN} = 1.8V to 5.5V, I _{OUT} = 100μA	+25°C		0.3		%/V
Output Load Regulation		I _{OUT} = 100μA to 200mA	+25°C		0.002		%/mA
Output Ripple		I _{OUT} = 1mA	+25°C		15		mV _{PP}
POWER SWITCH							
High-Side Switch ON Resistance	R _{DS(ON)}		+25°C		510	620	mΩ
Low-Side Switch ON Resistance			+25°C		530	690	
Cycle-by-Cycle Current Limit	I _{LIM}		+25°C	355	430	510	mA
Maximum Switching Frequency	f _{SW}		+25°C		1.4		MHz
INPUT							
Input Under Voltage Protection	V _{IN_UVLO}	V _{IN} falling	+25°C	1.19	1.3		V
VS							
VS Leakage Current	I _{VSH}	V _{VS} = 5.5V	+25°C		0.1	1	μA
Voltage for VS High Setting	V _{IH}		Full	1			V
Voltage for VS Low Setting	V _{IL}		Full			0.25	
Power-On Blanking Time	t _{BLANK}		+25°C		66		ms
VS Change Stop Time	t _{STOP}		+25°C	8	11	14	ms
Shutdown Delay	t _{OFF}		+25°C	99	135	170	ms
t _{OFF} Hold On Time	t _{OFF-HOLD}		+25°C	38	53	66	ms
Effective Pulse Time	t _{PULSE}		+25°C	1.5		2.5	ms
Soft Start Time	t _{SS}		+25°C		26		ms
THERMAL SHUTDOWN							
Thermal Shutdown	T _{TSD}				160		°C
Thermal Shutdown Hysteresis	T _{HYS}				20		°C

TYPICAL PERFORMANCE CHARACTERISTICS

T_A = +25°C, unless otherwise noted.

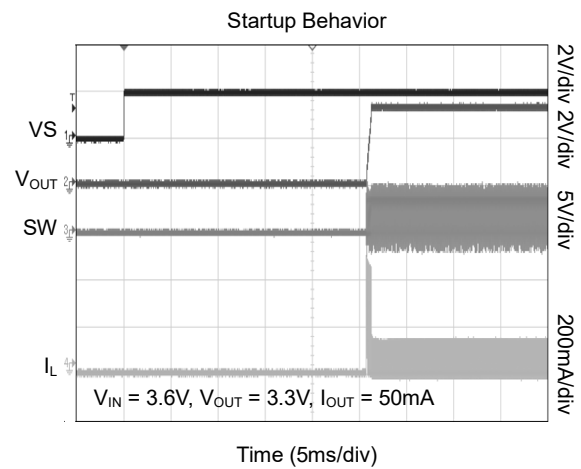
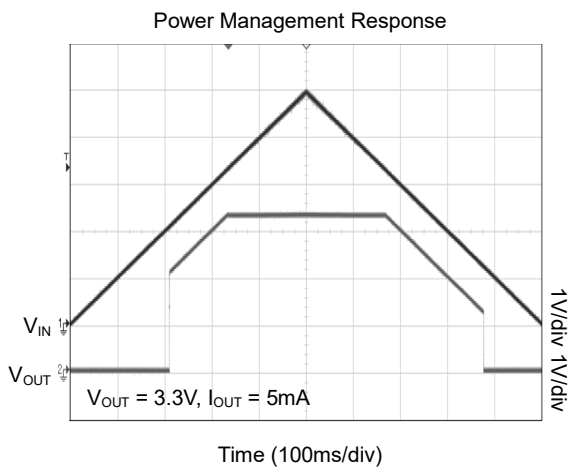
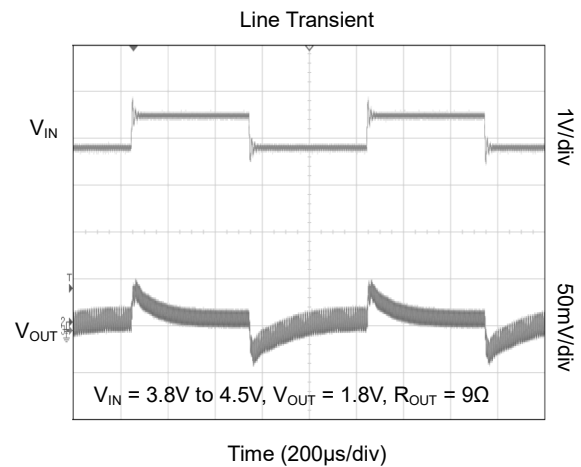
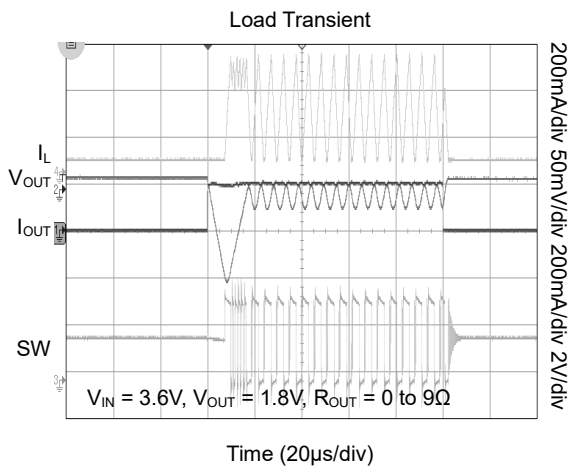
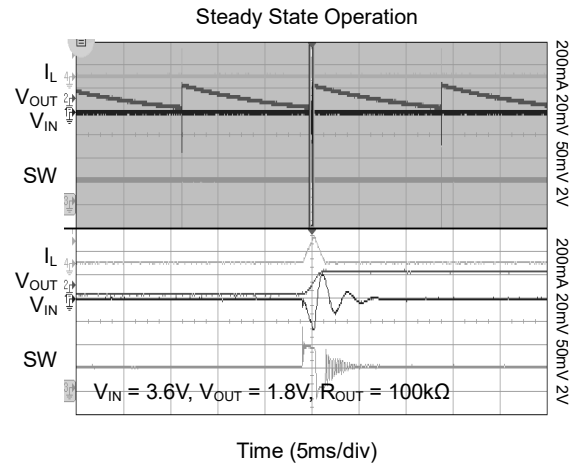
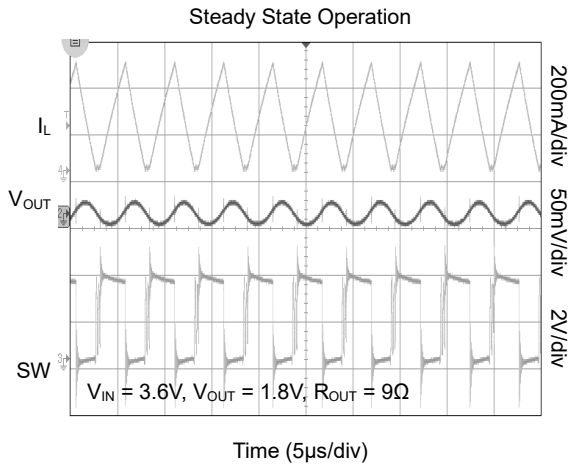

TYPICAL PERFORMANCE CHARACTERISTICS (continued)

T_A = +25°C, unless otherwise noted.

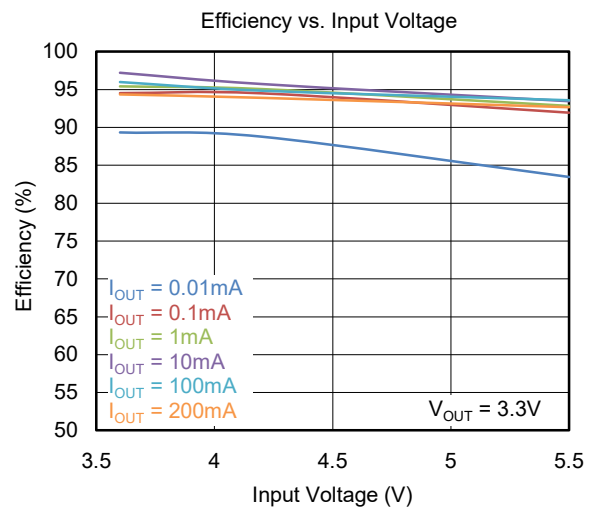
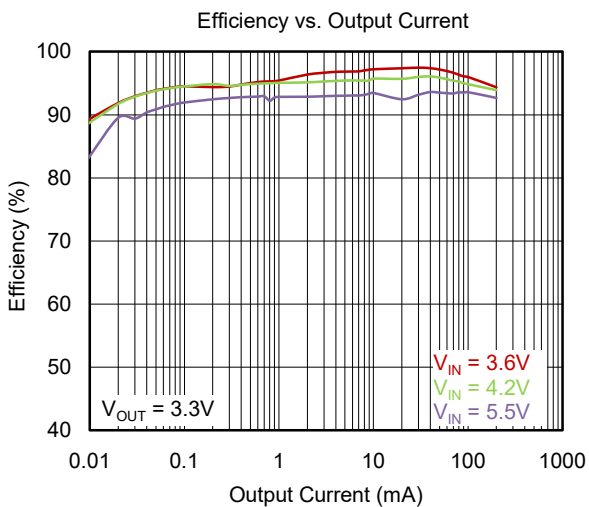
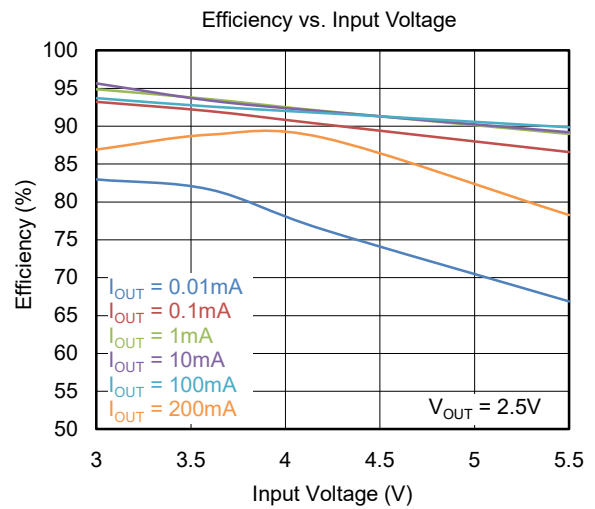
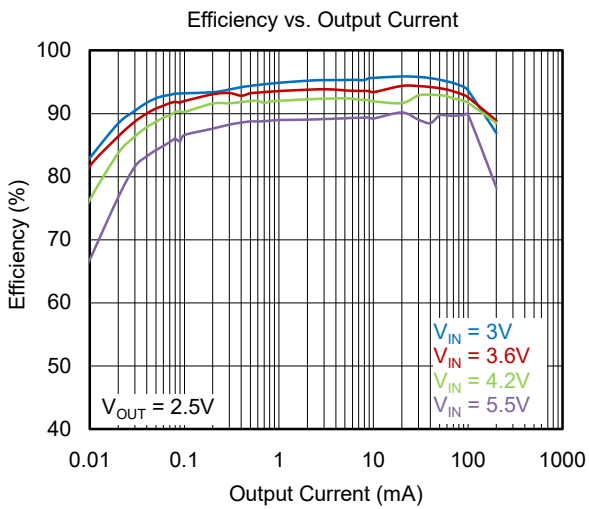
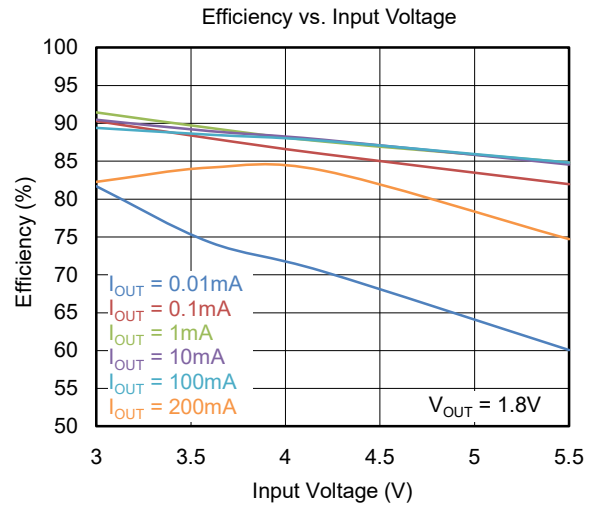
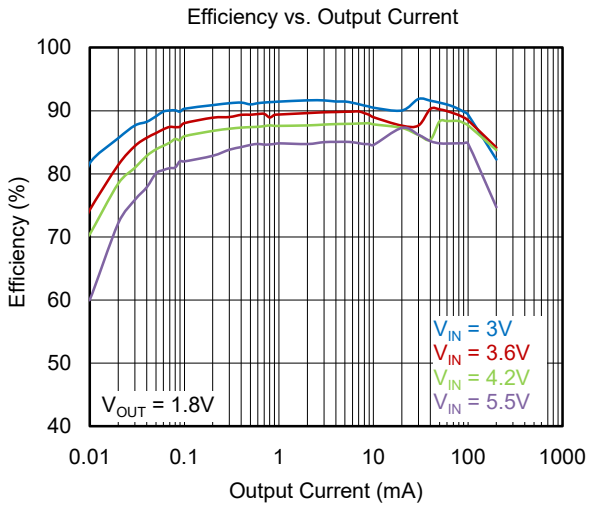

TYPICAL PERFORMANCE CHARACTERISTICS (continued)

T_A = +25°C, unless otherwise noted.

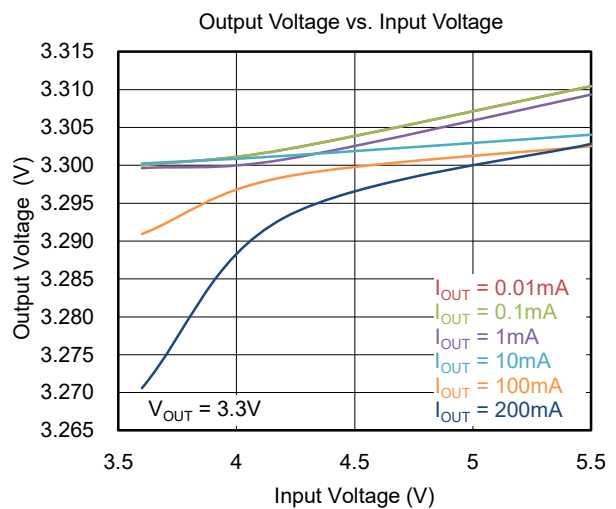
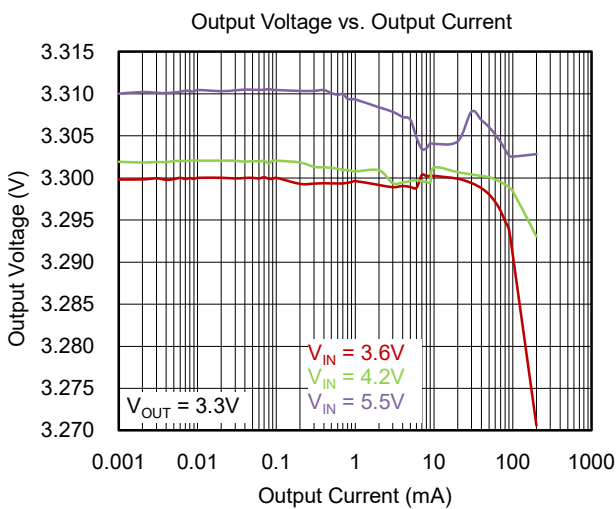
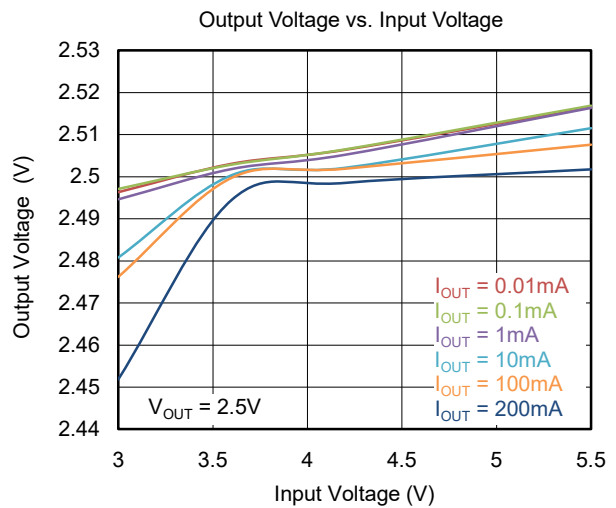
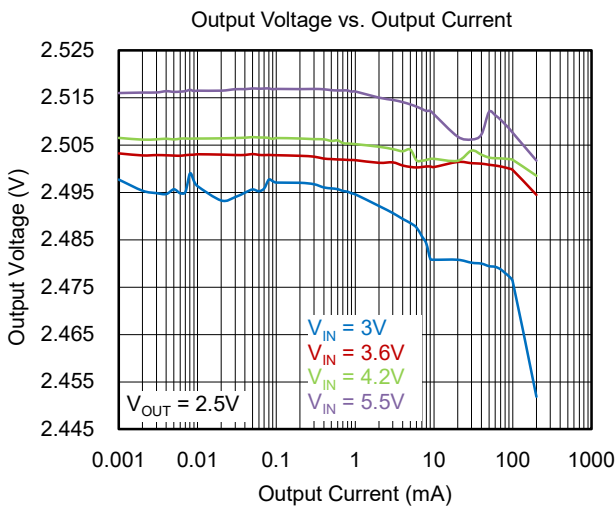
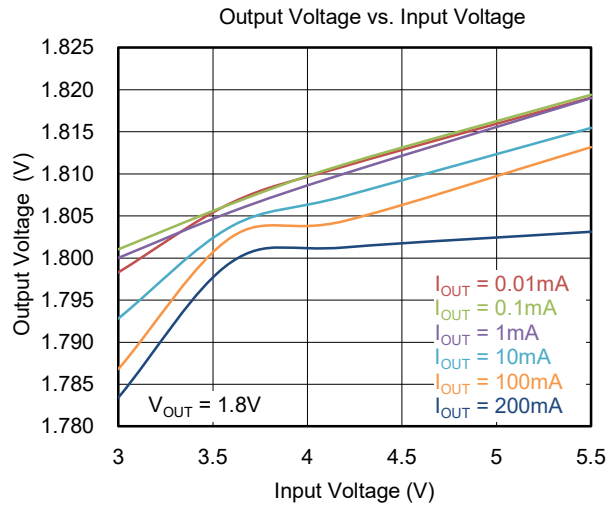
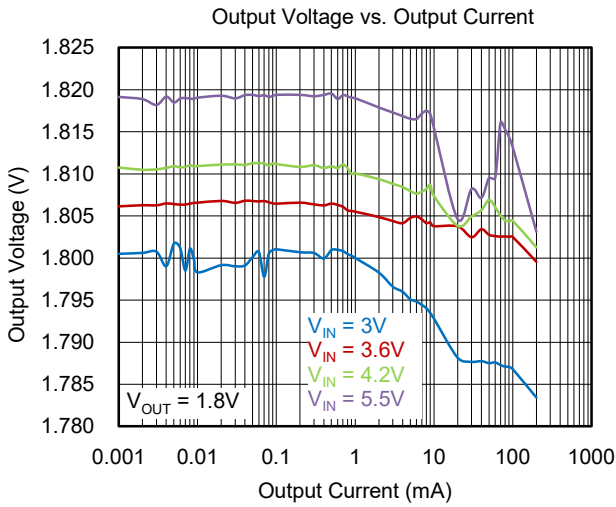

TYPICAL PERFORMANCE CHARACTERISTICS (continued)

T_A = +25°C, unless otherwise noted.

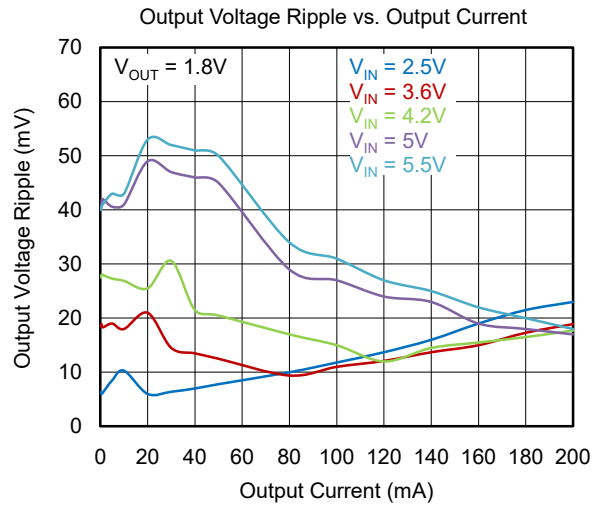
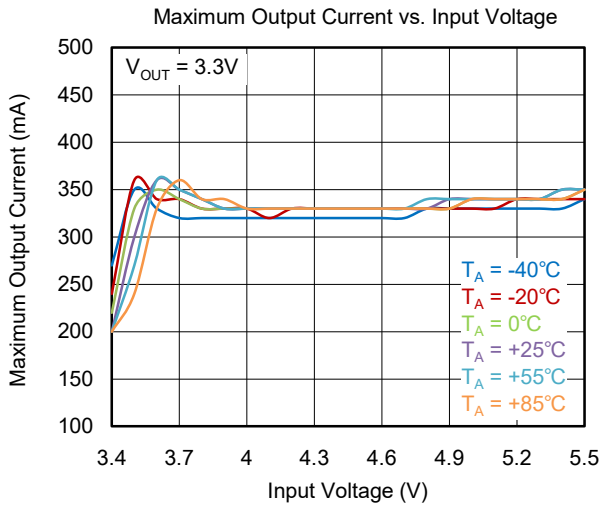

FUNCTIONAL BLOCK DIAGRAM

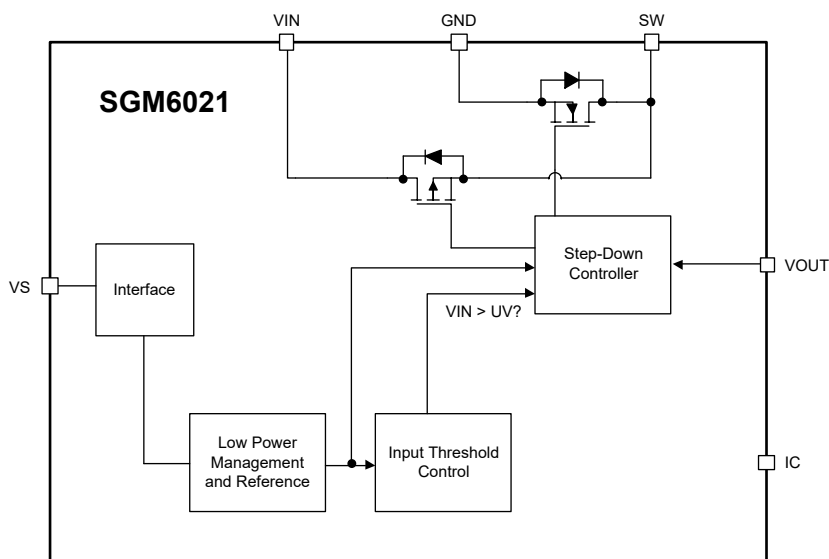

Figure 2. Block Diagram

DETAILED DESCRIPTION

Effective Pulse at VS Pin

A pulse with width less than t_{PULSE} is treated as an effective pulse. Consecutive pulses will be counted if delay between adjacent pulses is within the t_{STOP} . Please refer to Figure 3 for a graphical explanation.

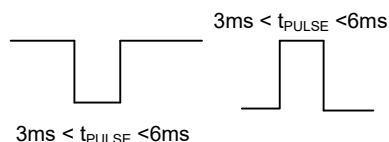

Figure 3. Effective Pulse at VS Pin

VS Pin Interface Functions

In order to enable the IC from shutdown mode, two conditions must be met:

1. VIN voltage is higher than UVLO threshold.
2. VS pin is floating or VS pin stays logic high for at least $t_{BLANK} + t_{SS}$ time.

After that, the pulses at VS pin become effective and can be used to shut down the IC or program the output voltage. The following are the three cases that the VS pin affects the regulator:

1. 1 pulse followed by VS pin being low for longer than t_{OFF} will shut down the regulator.

During the $t_{OFF-HOLD}$ time after shutdown, the pulses applied to VS Pin are ignored.

To restart the regulator, the VS pin must be pulled high for at least t_{SS} time.

2. 2~5 pulses followed by VS pin being high for longer than t_{OFF} will set the output voltage to the default, V1, V2 and V3 respectively.

3. 2 or more pulses followed by VS pin being low for longer than t_{OFF} will set the output voltage to the default value.

Other pulse patterns will have no effects on the IC.

Under-Voltage Lockout (UVLO)

When the input voltage is below the UVLO threshold, the device is shut down. If the input voltage rises above the UVLO threshold plus hysteresis, the IC will restart.

Thermal Shutdown (TSD)

A thermal shutdown function is implemented to prevent damage caused by excessive heat and power dissipation. Once a temperature of typically $+160^{\circ}\text{C}$ is exceeded, the device is shut down. The device is released from shutdown automatically when the junction temperature decreases by $+20^{\circ}\text{C}$.

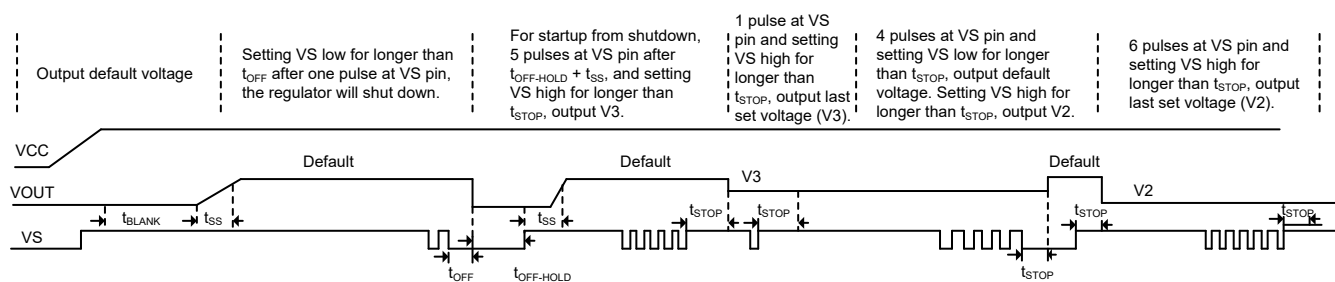

Figure 4. Program Output Voltage via VS Pin

REVISION HISTORY

NOTE: Page numbers for previous revisions may differ from page numbers in the current version.

AUGUST 2017 – REV.A to REV.A.1

Changed SGM6021-4 STATUS from PREVIEW to ACTIVE	2
---	---

Changes from Original (JUNE 2017) to REV.A

Changed from product preview to production data.....	All
--	-----

PACKAGE OUTLINE DIMENSIONS

UTDFN-1.5×2-6L

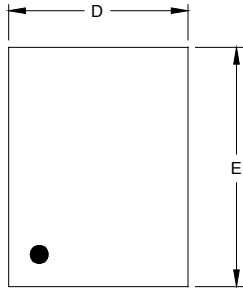

TOP VIEW

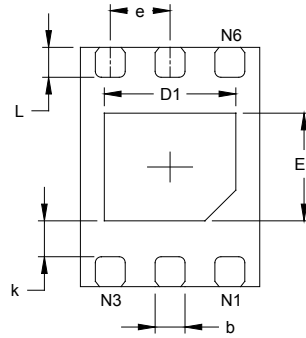

BOTTOM VIEW

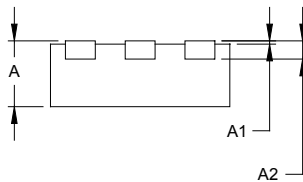

SIDE VIEW

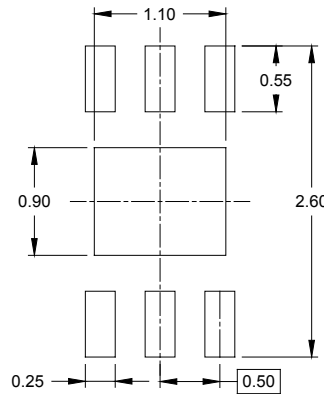

RECOMMENDED LAND PATTERN (Unit: mm)

Symbol	Dimensions In Millimeters		Dimensions In Inches	
	MIN	MAX	MIN	MAX
A	0.500	0.600	0.020	0.024
A1	0.000	0.050	0.000	0.002
A2	0.152 REF		0.006 REF	
D	1.400	1.600	0.055	0.063
D1	1.000	1.200	0.039	0.047
E	1.900	2.100	0.075	0.083
E1	0.800	1.000	0.031	0.039
k	0.300 REF		0.012 REF	
b	0.200	0.300	0.008	0.012
e	0.500 BSC		0.020 BSC	
L	0.200	0.300	0.008	0.012

PACKAGE INFORMATION

TAPE AND REEL INFORMATION

REEL DIMENSIONS

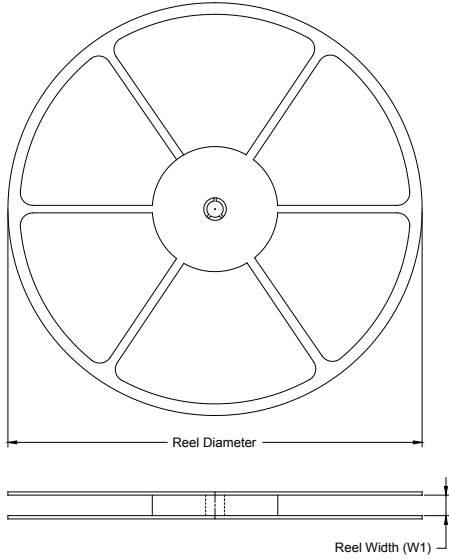

TAPE DIMENSIONS

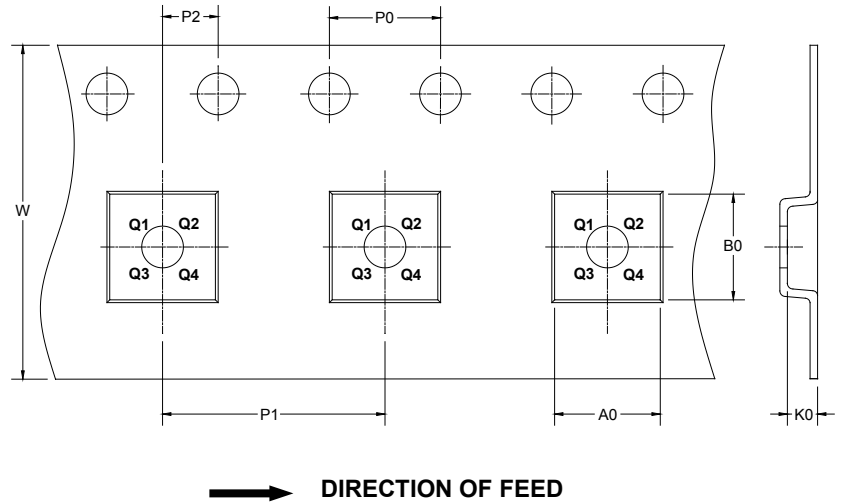

NOTE: The picture is only for reference. Please make the object as the standard.

KEY PARAMETER LIST OF TAPE AND REEL

Package Type	Reel Diameter	Reel Width W1 (mm)	A0 (mm)	B0 (mm)	K0 (mm)	P0 (mm)	P1 (mm)	P2 (mm)	W (mm)	Pin1 Quadrant
UTDFN-1.5×2-6L	7"	9.5	1.70	2.30	0.75	4.0	4.0	2.0	8.0	Q2

000001

PACKAGE INFORMATION

CARTON BOX DIMENSIONS



NOTE: The picture is only for reference. Please make the object as the standard.

KEY PARAMETER LIST OF CARTON BOX

Reel Type	Length (mm)	Width (mm)	Height (mm)	Pizza/Carton
7" (Option)	368	227	224	8
7"	442	410	224	18

DD0002

单击下面可查看定价，库存，交付和生命周期等信息

[>>SGMICRO\(圣邦微电子\)](#)