

### GENERAL DESCRIPTION

The SGM2207 is a high voltage, low noise and low dropout voltage linear regulator. It is capable of supplying 800mA output current with typical dropout voltage of only 400mV. The operating input voltage range is from 2.5V to 20V.

Other features include logic-controlled shutdown mode, short-circuit current limit and thermal shutdown protection. The SGM2207 has automatic discharge function to quickly discharge  $V_{OUT}$  in the disabled status.

The SGM2207 is available in a Green TDFN-2×3-8BL package. It operates over an operating temperature range of -40°C to +125°C.

### FEATURES

- **Wide Operating Input Voltage Range: 2.5V to 20V**
- **Adjustable Output from 1.8V to 15V**
- **Low Dropout Voltage: 400mV (TYP) at 800mA**
- **Current Limiting and Thermal Protection**
- **Excellent Load and Line Transient Responses**
- **With Output Automatic Discharge**
- **No-Load Stability**
- **Low Output Voltage Temperature Coefficient**
- **-40°C to +125°C Operating Temperature Range**
- **Available in a Green TDFN-2×3-8BL Package**

### APPLICATIONS

Cellular Telephones  
 Palmtop Computers  
 High-Efficiency Linear Power Supplies  
 Portable Equipment  
 Battery-Powered Systems

### TYPICAL APPLICATION

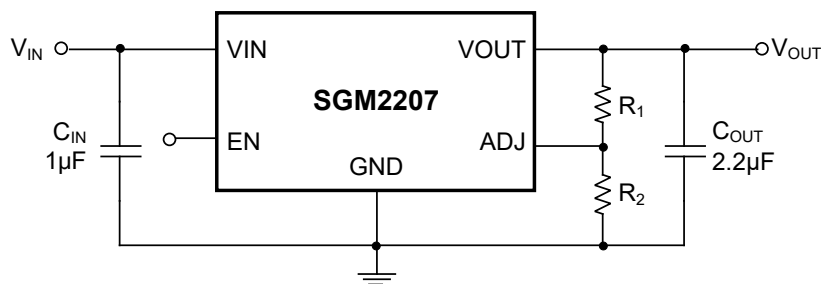

Figure 1. Typical Application Circuit

**PACKAGE/ORDERING INFORMATION**

MODEL	PACKAGE DESCRIPTION	SPECIFIED TEMPERATURE RANGE	ORDERING NUMBER	PACKAGE MARKING	PACKING OPTION
SGM2207-ADJ	TDFN-2×3-8BL	-40°C to +125°C	SGM2207-ADJXTDC8G/TR	CZ2 XXXX	Tape and Reel, 3000

**MARKING INFORMATION**

NOTE: X = Date Code. XXX = Trace Code.

**YYY** — Serial Number

**XXX**

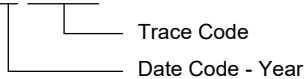

Green (RoHS & HSF): SG Micro Corp defines "Green" to mean Pb-Free (RoHS compatible) and free of halogen substances. If you have additional comments or questions, please contact your SGMICRO representative directly.

**ABSOLUTE MAXIMUM RATINGS**

- Supply Voltage Range,  $V_{IN}$ ..... -24V to +24V
- OUT to GND ( $V_{IN} \geq 0V$ )
- ..... -0.3V to ( $V_{IN} + 5.5V$ ) or +24V (whichever is lower)
- EN to GND ( $V_{IN} \geq 0V$ ) ..... -0.3V to +24V
- ADJ to GND ( $V_{IN} \geq 0V$ )..... -0.3V to +6V
- Package Thermal Resistance
- TDFN-2×3-8BL,  $\theta_{JA}$ ..... 91°C/W
- TDFN-2×3-8BL,  $\theta_{JB}$ ..... 44°C/W
- TDFN-2×3-8BL,  $\theta_{JC}$  ..... 57°C/W
- Junction Temperature ..... +150°C
- Storage Temperature Range ..... -65°C to +150°C
- Lead Temperature (Soldering, 10s) ..... +260°C
- ESD Susceptibility
- HBM..... 6000V
- CDM ..... 1000V

**RECOMMENDED OPERATING CONDITIONS**

- Supply Voltage Range,  $V_{IN}$  ..... 2.5V to 20V
- Adjustable Output Voltage Range..... 1.8V to 15V
- Input Effective Capacitance,  $C_{IN}$  ..... 0.5µF (MIN)
- Output Effective Capacitance,  $C_{OUT}$ ..... 1µF to 10µF
- Operating Junction Temperature Range ..... -40°C to +125°C

**OVERSTRESS CAUTION**

Stresses beyond those listed in Absolute Maximum Ratings may cause permanent damage to the device. Exposure to absolute maximum rating conditions for extended periods may affect reliability. Functional operation of the device at any conditions beyond those indicated in the Recommended Operating Conditions section is not implied.

**ESD SENSITIVITY CAUTION**

This integrated circuit can be damaged if ESD protections are not considered carefully. SGMICRO recommends that all integrated circuits be handled with appropriate precautions. Failure to observe proper handling and installation procedures can cause damage. ESD damage can range from subtle performance degradation to complete device failure. Precision integrated circuits may be more susceptible to damage because even small parametric changes could cause the device not to meet the published specifications.

**DISCLAIMER**

SG Micro Corp reserves the right to make any change in circuit design, or specifications without prior notice.

PIN CONFIGURATION

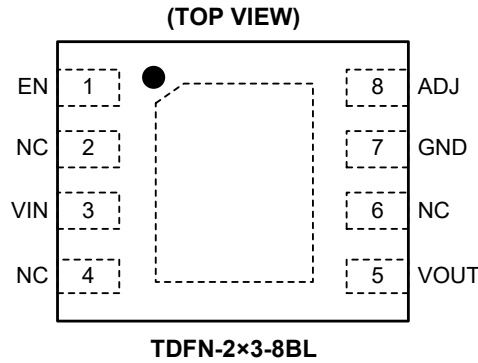

PIN DESCRIPTION

PIN	NAME	FUNCTION
1	EN	Enable Pin. Drive EN high to turn on the regulator. Drive EN low to turn off the regulator.
2, 4, 6	NC	No Connection.
3	VIN	Input Supply Voltage Pin. It is recommended to use a 1μF or larger ceramic capacitor from VIN pin to ground to get good power supply decoupling.
5	VOUT	Regulator Output Pin. It is recommended to use an output capacitor with effective capacitance in the range of 1μF to 10μF to ensure stability.
7	GND	Ground.
8	ADJ	Feedback Voltage Input Pin. Connect this pin to the midpoint of an external resistor divider to adjust the output voltage. Place the resistors as close as possible to this pin.
Exposed Pad	-	Exposed Pad. Connect it to GND internally. Connect it to a large ground plane to maximize thermal performance; this pad is not an electrical connection point.

## ELECTRICAL CHARACTERISTICS

( $T_J = -40^\circ\text{C}$  to  $+125^\circ\text{C}$ , typical values are at  $T_J = +25^\circ\text{C}$ ,  $V_{IN} = V_{OUT(NOM)} + 1\text{V}$ ,  $C_{OUT} = 2.2\mu\text{F}$ ,  $I_{OUT} = 100\mu\text{A}$ , unless otherwise noted.)

PARAMETER	SYMBOL	CONDITIONS	MIN	TYP	MAX	UNITS
Input Voltage Range	$V_{IN}$	$T_J = +25^\circ\text{C}$	2.5		20	V
Reference Voltage	$V_{REF}$	$T_J = +25^\circ\text{C}$	1.223	1.235	1.247	V
			1.216		1.254	
Line Regulation	$\frac{\Delta V_{OUT}}{\Delta V_{IN} \times V_{OUT}}$	$V_{IN} = (V_{OUT(NOM)} + 1\text{V})$ to 20V, $T_J = +25^\circ\text{C}$		0.0003	0.003	%V
		$V_{IN} = (V_{OUT(NOM)} + 1\text{V})$ to 20V			0.005	
Load Regulation	$\frac{\Delta V_{OUT}}{V_{OUT}}$	$I_{OUT} = 100\mu\text{A}$ to 800mA, $T_J = +25^\circ\text{C}$		0.1	0.3	%
		$I_{OUT} = 100\mu\text{A}$ to 800mA			0.4	
Dropout Voltage <sup>(1)</sup>	$V_{DROP}$	$V_{OUT} = 3.3\text{V}$ , $I_{OUT} = 50\text{mA}$ , $T_J = +25^\circ\text{C}$		25	40	mV
		$V_{OUT} = 3.3\text{V}$ , $I_{OUT} = 50\text{mA}$			45	
		$V_{OUT} = 3.3\text{V}$ , $I_{OUT} = 200\text{mA}$ , $T_J = +25^\circ\text{C}$		100	130	
		$V_{OUT} = 3.3\text{V}$ , $I_{OUT} = 200\text{mA}$			185	
		$V_{OUT} = 3.3\text{V}$ , $I_{OUT} = 800\text{mA}$ , $T_J = +25^\circ\text{C}$		400	510	
		$V_{OUT} = 3.3\text{V}$ , $I_{OUT} = 800\text{mA}$			750	
Output Current Limit	$I_{LIMIT}$	$V_{OUT} = 93\% \times V_{OUT(NOM)}$ , $T_J = +25^\circ\text{C}$	820	1100		mA
Short-Circuit Current	$I_{SHORT}$	$V_{IN} = V_{EN} = 3\text{V}$ , $V_{OUT} = 0\text{V}$		230		mA
Ground Pin Current	$I_Q$	$V_{EN} \geq 1.2\text{V}$ , no load, $T_J = +25^\circ\text{C}$		80	104	$\mu\text{A}$
		$V_{EN} \geq 1.2\text{V}$ , no load			120	
		$V_{EN} \geq 1.2\text{V}$ , $I_{OUT} = 100\mu\text{A}$ , $T_J = +25^\circ\text{C}$		80	104	
		$V_{EN} \geq 1.2\text{V}$ , $I_{OUT} = 100\mu\text{A}$			120	
		$V_{EN} \geq 1.2\text{V}$ , $I_{OUT} = 50\text{mA}$ , $T_J = +25^\circ\text{C}$		220	280	
		$V_{EN} \geq 1.2\text{V}$ , $I_{OUT} = 50\text{mA}$			290	
		$V_{EN} \geq 1.2\text{V}$ , $I_{OUT} = 800\text{mA}$ , $T_J = +25^\circ\text{C}$		1950	2250	
		$V_{EN} \geq 1.2\text{V}$ , $I_{OUT} = 800\text{mA}$			2350	
Ground Pin Quiescent Current	$I_{Q(GND)}$	$V_{EN} \leq 0.4\text{V}$ (shutdown), $T_J = +25^\circ\text{C}$		2.7	3.5	$\mu\text{A}$
		$V_{EN} \leq 0.4\text{V}$ (shutdown)			6.8	
Enable Input Logic Low Voltage	$V_{EN}$	$V_{EN} = \text{logic low}$ (regulator shutdown)			0.4	V
		$V_{EN} = \text{logic high}$ (regulator enabled)	1.2			
Enable Input Current	$I_{ENL}$	$V_{EN} \leq 0.4\text{V}$			0.3	$\mu\text{A}$
	$I_{ENH}$	$V_{EN} = V_{IN}$			1	
Power Supply Rejection Ratio	PSRR	$f = 1\text{kHz}$ , $V_{OUT} = 2.5\text{V}$ , $I_{OUT} = 50\text{mA}$		75		dB
Output Voltage Noise	$e_n$	$V_{OUT} = 1.8\text{V}$ , $I_{OUT} = 50\text{mA}$ , $f = 10\text{Hz}$ to $100\text{kHz}$		110		$\mu\text{V}_{RMS}$
Output Voltage Temperature Coefficient	$\frac{\Delta V_{OUT}}{\Delta T_J \times V_{OUT}}$	$T_J = -40^\circ\text{C}$ to $+125^\circ\text{C}$		40		ppm/ $^\circ\text{C}$
Thermal Shutdown Temperature	$T_{SHDN}$			155		$^\circ\text{C}$
Thermal Shutdown Hysteresis	$\Delta T_{SHDN}$			25		$^\circ\text{C}$

## NOTE:

1. The dropout voltage is defined as the difference between  $V_{IN}$  and  $V_{OUT}$  when  $V_{OUT}$  falls to  $95\% \times V_{OUT(NOM)}$ .

TYPICAL PERFORMANCE CHARACTERISTICS

$T_J = +25^\circ\text{C}$ ,  $C_{OUT} = 2.2\mu\text{F}$  and  $I_{OUT} = 100\mu\text{A}$ , unless otherwise noted.

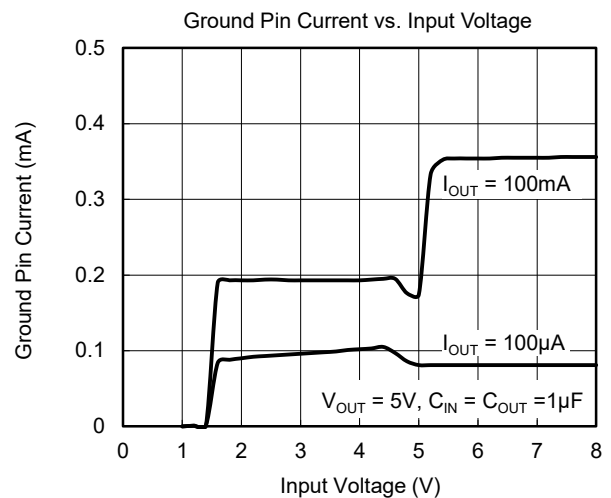
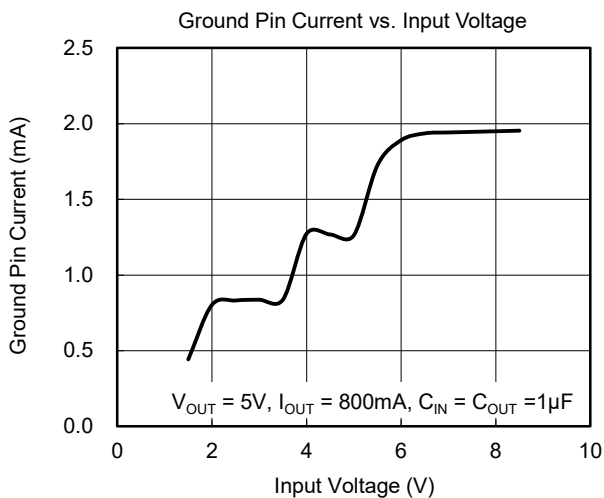
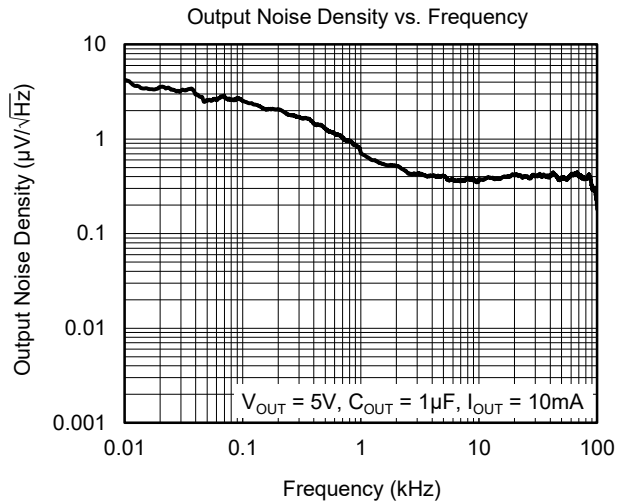
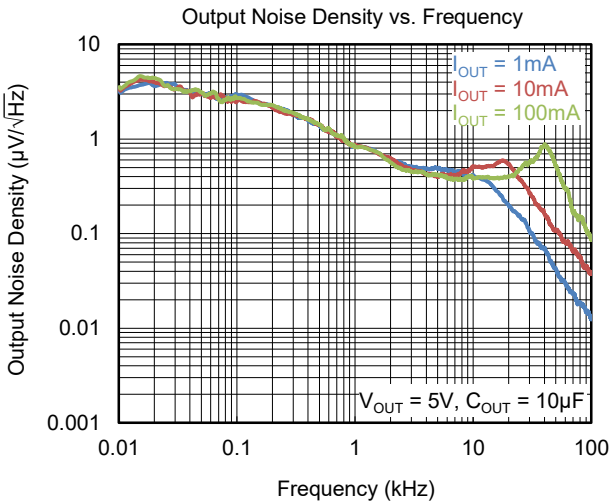
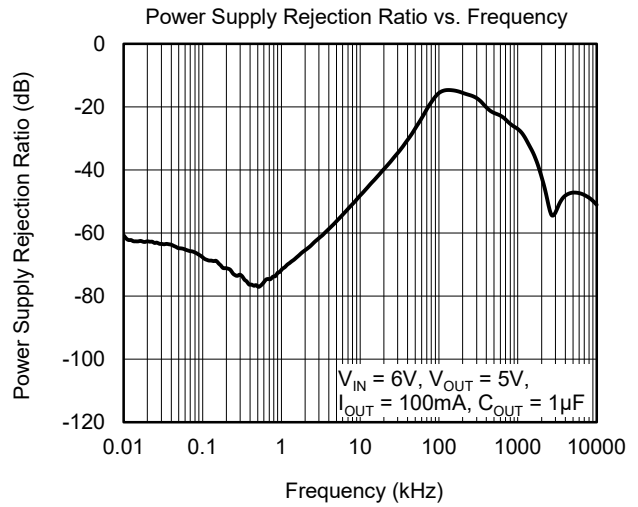
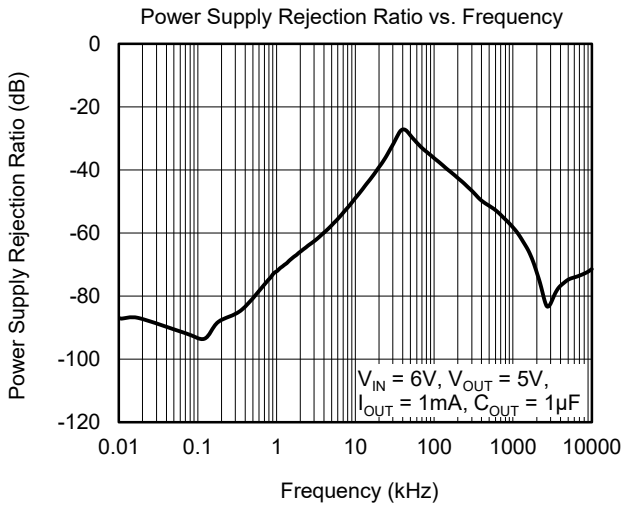

TYPICAL PERFORMANCE CHARACTERISTICS (continued)

$T_J = +25^\circ\text{C}$ ,  $C_{OUT} = 2.2\mu\text{F}$  and  $I_{OUT} = 100\mu\text{A}$ , unless otherwise noted.

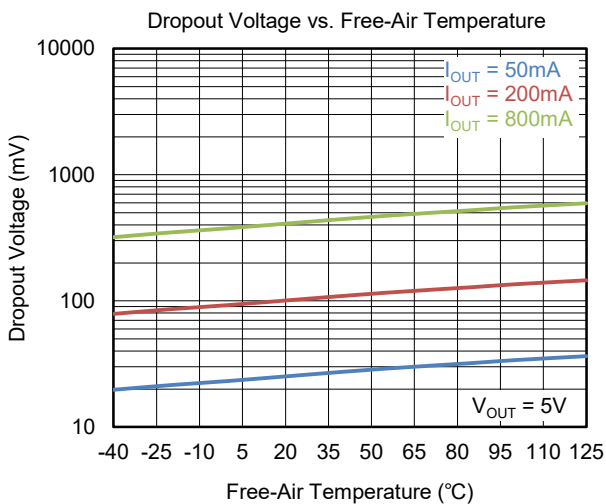
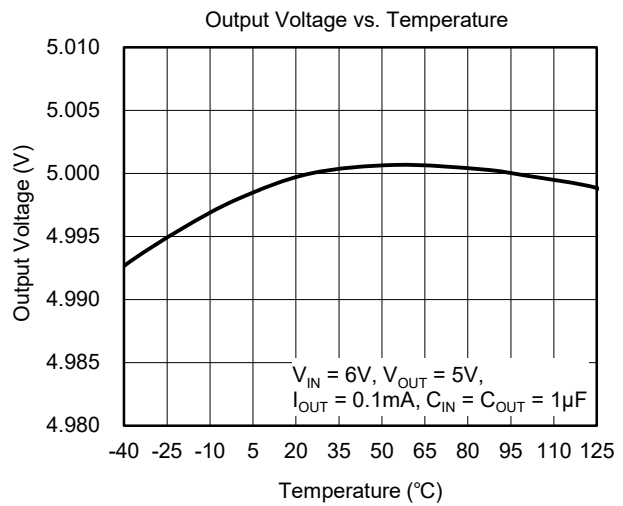
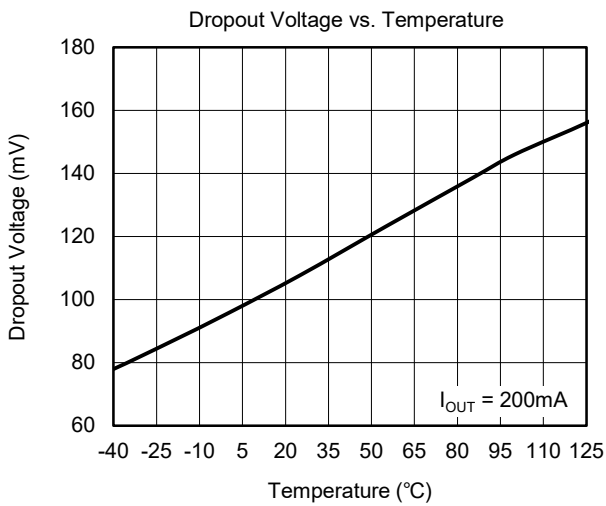
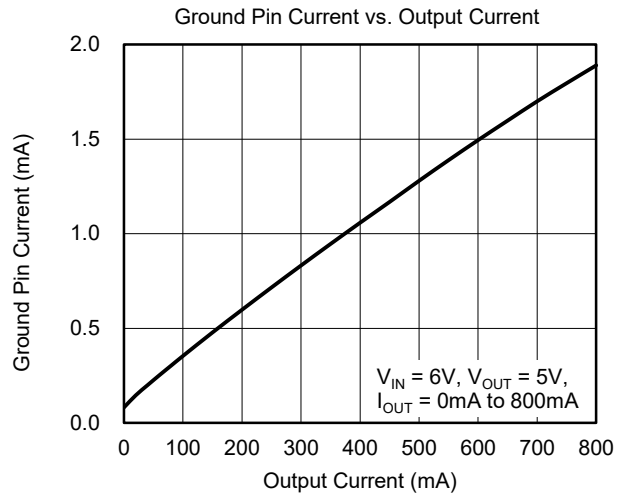
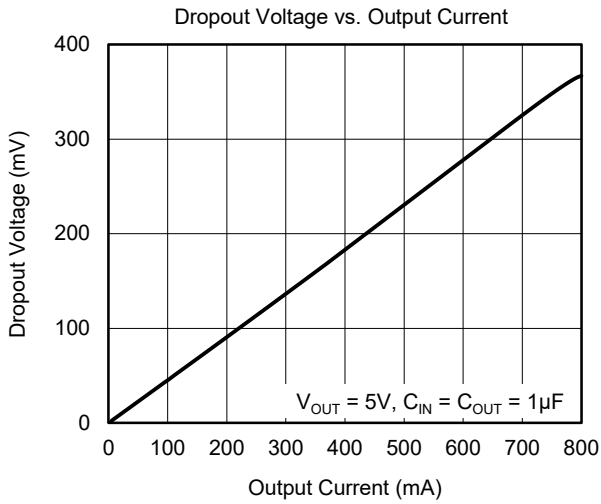

TYPICAL PERFORMANCE CHARACTERISTICS (continued)

$T_J = +25^\circ\text{C}$ ,  $C_{OUT} = 2.2\mu\text{F}$  and  $I_{OUT} = 100\mu\text{A}$ , unless otherwise noted.

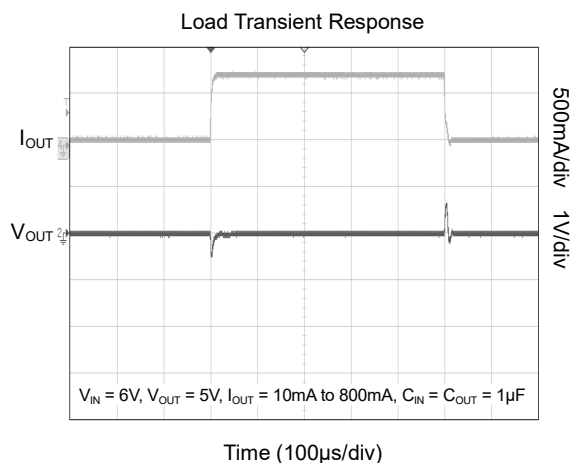
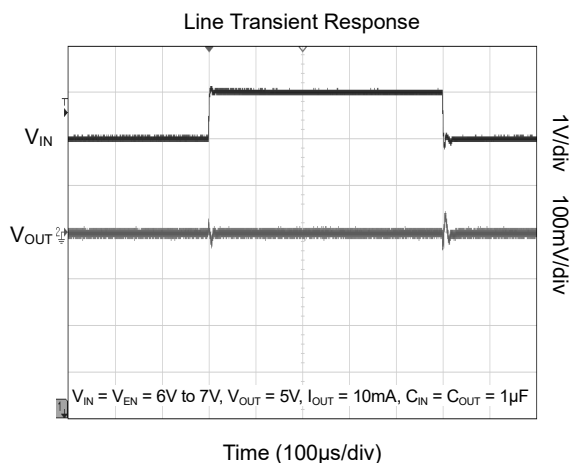
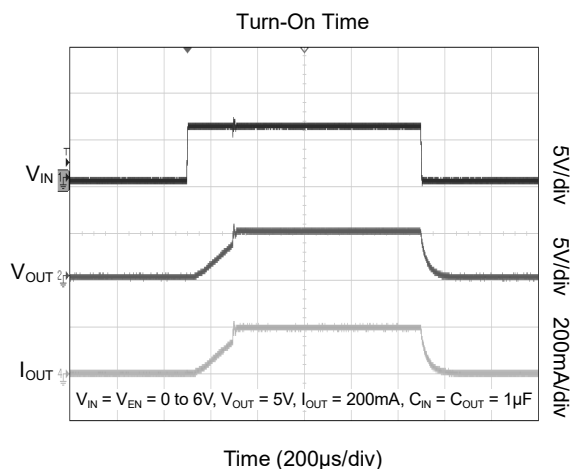
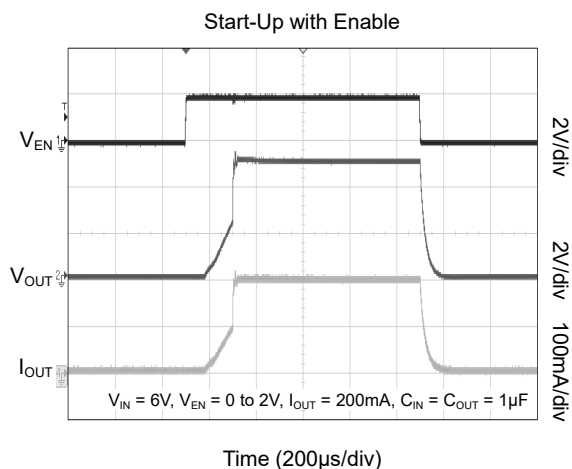

FUNCTIONAL BLOCK DIAGRAM

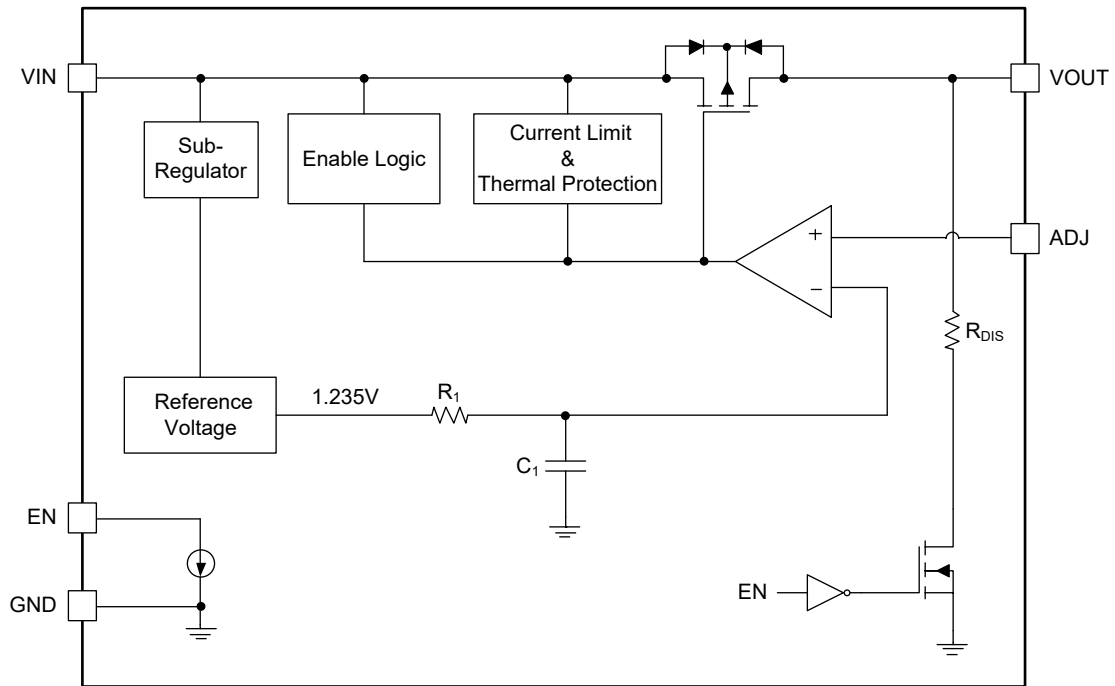

Figure 2. Block Diagram



APPLICATION INFORMATION

The SGM2207 is a high voltage, low noise and low dropout LDO and provides 800mA output current. These features make the device a reliable solution to solve many challenging problems in the generation of clean and accurate power supply. The high performance also makes the SGM2207 useful in a variety of applications. The SGM2207 provides protection functions for output overload, output short-circuit condition and overheating.

The SGM2207 provides an EN pin as an external chip enable control to enable/disable the device.

Input Capacitor Selection (C<sub>IN</sub>)

The input decoupling capacitor should be placed as close as possible to the VIN pin for ensuring the device stability. 1µF or larger X7R or X5R ceramic capacitor is selected to get good dynamic performance.

When V<sub>IN</sub> is required to provide large current instantaneously, a large effective input capacitor is required. Multiple input capacitors can limit the input tracking inductance. Adding more input capacitors is available to restrict the ringing and to keep it below the device absolute maximum ratings.

Output Capacitor Selection (C<sub>OUT</sub>)

The output capacitor should be placed as close as possible to the VOUT pin. 2.2µF or larger X7R or X5R ceramic capacitor is selected to get good dynamic performance. The minimum effective capacitance of C<sub>OUT</sub> that SGM2207 can remain stable is 1µF. For ceramic capacitor, temperature, DC bias and package size will change the effective capacitance, so enough margin of C<sub>OUT</sub> must be considered in design. Additionally, C<sub>OUT</sub> with larger capacitance and lower ESR will help increase the high frequency PSRR and improve the load transient response.

Adjustable Regulator

The output voltage of the SGM2207 can be adjusted from 1.8V to 15V. The ADJ pin will be connected to two external resistors as shown in Figure 3, the output voltage is determined by the following equation:

$$V_{OUT} = V_{REF} \times \left( 1 + \frac{R_1}{R_2} \right) \tag{1}$$

where:

V<sub>OUT</sub> is output voltage and V<sub>REF</sub> is the internal voltage reference, V<sub>REF</sub> = 1.235V.

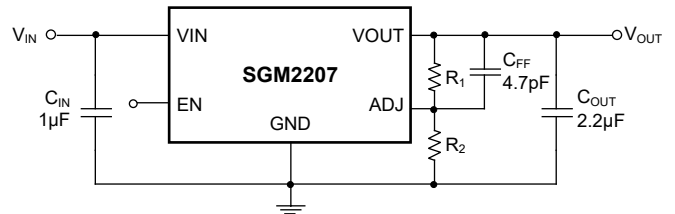

Figure 3. Adjustable Output Voltage Application

Choose R<sub>2</sub> = 150kΩ to maintain an about 8µA minimum load. R<sub>1</sub> and R<sub>2</sub> can be calculated for any output voltage range using equation 1 and R<sub>1</sub> is recommended to be less than 470kΩ.

Enable Operation

The EN pin of the SGM2207 is used to enable/disable the device and to deactivate/activate the output automatic discharge function.

When the EN pin voltage is lower than 0.4V, the device is in shutdown state. There is no current flowing from VIN to VOUT pins. In this state, the automatic discharge transistor is active to discharge the output voltage through a resistor.

When the EN pin voltage is higher than 1.2V, the device is in active state. The output voltage is regulated to expected value and the automatic discharge transistor is turned off.

No-Load Stability

The SGM2207 can maintain stability without output load (except internal voltage divider).

Input Power Supply

The input power supply range is from 2.5V to 20V. V<sub>IN</sub> must be larger than (V<sub>OUT</sub> + V<sub>DROP</sub>) in application. The input ceramic capacitor must be placed as close as possible to the VIN pin, this C<sub>IN</sub> can help improve the output noise performance of LDO.

**APPLICATION INFORMATION (continued)**

**Output Current Limit and Short-Circuit Protection**

When overload events happen, the output current is internally limited to 1100mA (TYP). When the VOUT pin is shorted to ground, the short-circuit protection will limit the output current to 230mA (TYP).

**Power Dissipation (P<sub>D</sub>)**

Thermal protection limits power dissipation in the SGM2207. When power dissipation on pass element ( $P_D = (V_{IN} - V_{OUT}) \times I_{OUT}$ ) is too much and the operating junction temperature exceeds +155°C, the OTP circuit starts the thermal shutdown function and turns the pass element off.

Therefore, thermal analysis for the chosen application is important to guarantee reliable performance over all conditions. To guarantee reliable operation, the junction temperature of the SGM2207 must not exceed +125°C.

The maximum allowable power dissipation depends on the thermal resistance of the IC package, the PCB layout, the rate of surrounding airflow, and the difference between the junction temperature and ambient temperature. The maximum power dissipation can be approximated using the following equation:

$$P_{D(MAX)} = (T_{J(MAX)} - T_A) / \theta_{JA} \quad (2)$$

where  $T_{J(MAX)}$  is the maximum junction temperature,  $T_A$  is the ambient temperature, and  $\theta_{JA}$  is the junction -to-ambient thermal resistance.

**Layout Guidelines**

To get good PSRR, low output noise and high transient response performance, the input and output bypass capacitors must be placed as close as possible to the VIN pin and VOUT pin separately. V<sub>IN</sub> and V<sub>OUT</sub> had better use separate ground planes and these ground planes are single point connected to the GND pin.

**REVISION HISTORY**

NOTE: Page numbers for previous revisions may differ from page numbers in the current version.

JUNE 2022 – REV.A to REV.A.1	Page
Updated RECOMMENDED OPERATING CONDITIONS.....	2
Updated Electrical Characteristics section.....	4
<hr/>	
Changes from Original (DECEMBER 2020) to REV.A	Page
Changed from product preview to production data.....	All

PACKAGE OUTLINE DIMENSIONS

TDFN-2x3-8BL

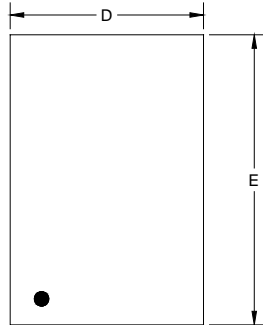

TOP VIEW

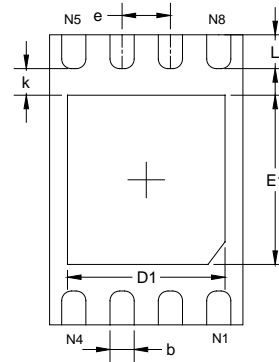

BOTTOM VIEW

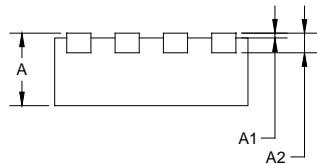

SIDE VIEW

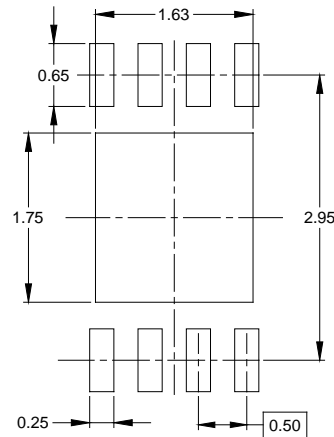

RECOMMENDED LAND PATTERN (Unit: mm)

Symbol	Dimensions In Millimeters		Dimensions In Inches	
	MIN	MAX	MIN	MAX
A	0.700	0.800	0.028	0.031
A1	0.000	0.050	0.000	0.002
A2	0.203 REF		0.008 REF	
D	1.950	2.050	0.077	0.081
D1	1.530	1.730	0.060	0.068
E	2.950	3.050	0.116	0.120
E1	1.650	1.850	0.065	0.073
b	0.200	0.300	0.008	0.012
e	0.500 BSC		0.020 BSC	
k	0.250 REF		0.010 REF	
L	0.300	0.450	0.012	0.018

NOTE: This drawing is subject to change without notice.

TAPE AND REEL INFORMATION

REEL DIMENSIONS

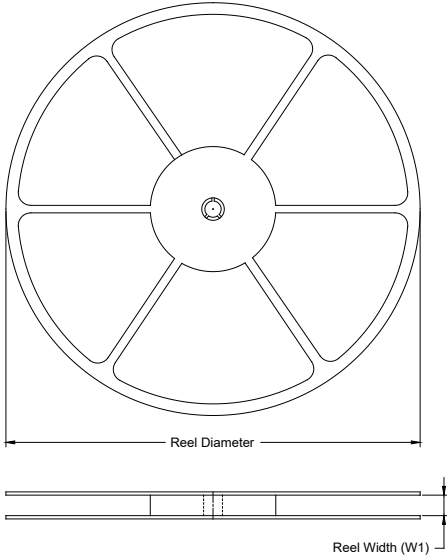

TAPE DIMENSIONS

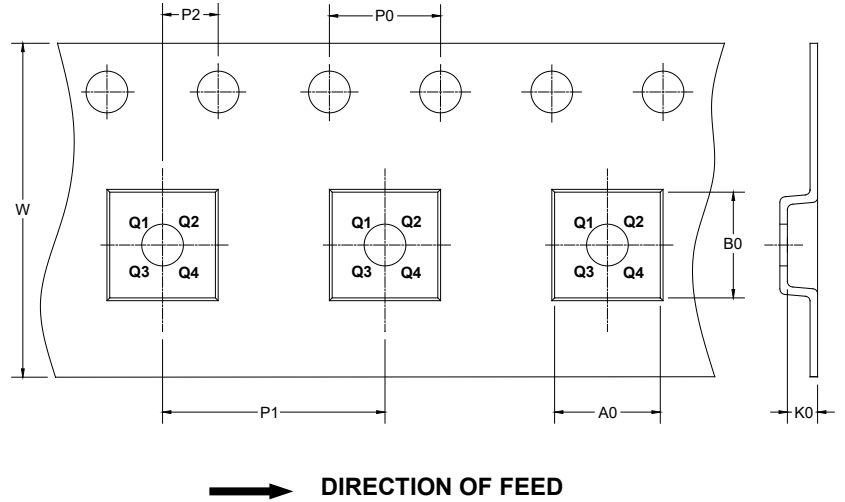

NOTE: The picture is only for reference. Please make the object as the standard.

KEY PARAMETER LIST OF TAPE AND REEL

Package Type	Reel Diameter	Reel Width W1 (mm)	A0 (mm)	B0 (mm)	K0 (mm)	P0 (mm)	P1 (mm)	P2 (mm)	W (mm)	Pin1 Quadrant
TDFN-2x3-8BL	7"	9.5	2.30	3.30	1.10	4.0	4.0	2.0	8.0	Q2

000001

# PACKAGE INFORMATION

## CARTON BOX DIMENSIONS



NOTE: The picture is only for reference. Please make the object as the standard.

## KEY PARAMETER LIST OF CARTON BOX

Reel Type	Length (mm)	Width (mm)	Height (mm)	Pizza/Carton
7" (Option)	368	227	224	8
7"	442	410	224	18

DD0002

单击下面可查看定价，库存，交付和生命周期等信息

[>>SGMICRO\(圣邦微电子\)](#)