



SGM8554

Single-Supply, Quad Rail-to-Rail I/O Precision Operational Amplifier

GENERAL DESCRIPTION

The SGM8554 is a quad, precision operational amplifier which can operate from 2.5V to 5.5V single supply. The device provides rail-to-rail input and output operation.

The SGM8554 offers a low offset voltage less than 25 μ V and an ultra-low bias current of 10pA. The combination of characteristics makes the SGM8554 a good choice for temperature measurements, pressure and position sensors, strain gauge amplifiers and medical instrumentation, or any other 2.5V to 5.5V applications requiring precision and long-term stability.

The SGM8554 is available in Green SOIC-14 and MSOP-14 packages. It is specified over the extended industrial temperature range (-40°C to +125°C).

FEATURES

- **Low Offset Voltage: 25 μ V (MAX)**
- **Ultra-Low Input Bias Current: 10pA**
- **Large-Signal Voltage Gain: 145dB (TYP) at 5V**
- **PSRR: 110dB (TYP)**
- **CMRR: 105dB (TYP)**
- **Overload Recovery Time: 60 μ s (at $V_S = 5V$)**
- **Rail-to-Rail Input and Output**
- **Supply Voltage Range: 2.5V to 5.5V**
- **Low Supply Current: 465 μ A/Amplifier (TYP)**
- **No External Capacitors Required**
- **-40°C to +125°C Operating Temperature Range**
- **Available in Green SOIC-14 and MSOP-14 Packages**

APPLICATIONS

Pressure Sensors
Temperature Measurements
Precision Current Sensing
Electronic Scales
Strain Gauge Amplifiers
Handheld Test Equipment
Thermocouple Amplifiers
Medical Instrumentation

PACKAGE/ORDERING INFORMATION

MODEL	PACKAGE DESCRIPTION	SPECIFIED TEMPERATURE RANGE	ORDERING NUMBER	PACKAGE MARKING	PACKING OPTION
SGM8554	SOIC-14	-40°C to +125°C	SGM8554XS14G/TR	SGM8554XS14 XXXXX	Tape and Reel, 2500
	TSSOP-14	-40°C to +125°C	SGM8554XTS14G/TR	SGM8554 XTS14 XXXXX	Tape and Reel, 3000

MARKING INFORMATION

NOTE: XXXXX = Date Code and Vendor Code.

SOIC-14/TSSOP-14

XXXXX

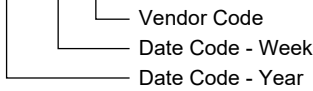

Green (RoHS & HSF): SG Micro Corp defines "Green" to mean Pb-Free (RoHS compatible) and free of halogen substances. If you have additional comments or questions, please contact your SGMICRO representative directly.

ABSOLUTE MAXIMUM RATINGS

- Supply Voltage.....6V
- Input Voltage Range-Vs to (+Vs) + 0.1V
- Differential Input Voltage Range -5V to 5V
- Junction Temperature.....+150°C
- Storage Temperature Range-65°C to +150°C
- Lead Temperature (Soldering, 10s).....+260°C
- ESD Susceptibility
- HBM (SOIC-14) 8000V
- MM (SOIC-14) 300V
- HBM (TSSOP-14) 7000V
- MM (TSSOP-14) 400V

RECOMMENDED OPERATING CONDITIONS

- Operating Temperature Range-40°C to +125°C

OVERSTRESS CAUTION

Stresses beyond those listed in Absolute Maximum Ratings may cause permanent damage to the device. Exposure to absolute maximum rating conditions for extended periods

may affect reliability. Functional operation of the device at any conditions beyond those indicated in the Recommended Operating Conditions section is not implied.

ESD SENSITIVITY CAUTION

This integrated circuit can be damaged if ESD protections are not considered carefully. SGMICRO recommends that all integrated circuits be handled with appropriate precautions. Failure to observe proper handling and installation procedures can cause damage. ESD damage can range from subtle performance degradation to complete device failure. Precision integrated circuits may be more susceptible to damage because even small parametric changes could cause the device not to meet the published specifications.

DISCLAIMER

SG Micro Corp reserves the right to make any change in circuit design, or specifications without prior notice.

PIN CONFIGURATIONS

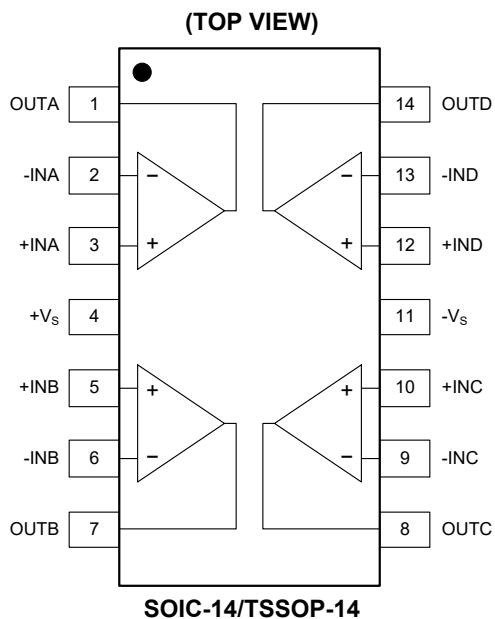

ELECTRICAL CHARACTERISTICS(At $T_A = +25^\circ\text{C}$, $V_S = 5\text{V}$, $V_{CM} = 2.5\text{V}$, $V_{OUT} = 2.5\text{V}$, Full = -40°C to $+125^\circ\text{C}$, unless otherwise noted.)

PARAMETER	CONDITIONS	TEMP	MIN	TYP	MAX	UNITS
Input Characteristics						
Input Offset Voltage (V_{OS})	$V_{CM} = V_S/2$	+25°C		12	25	μV
		Full			40	
Input Bias Current (I_b)		+25°C		10		pA
Input Offset Current (I_{OS})		+25°C		5		pA
Input Voltage Range		+25°C	0		5	V
Common Mode Rejection Ratio ⁽¹⁾ (CMRR)	$V_{CM} = 0\text{V}$ to 5V	+25°C	90	105		dB
		Full	88			
Large-Signal Voltage Gain (A_{VO})	$R_L = 10\text{k}\Omega$, $V_{CM} = V_S/2$, $V_{OUT} = 0\text{V}$ to 5V	+25°C	100	145		dB
		Full	98			
Input Offset Voltage Drift ($\Delta V_{OS}/\Delta T$)		Full		70		nV/°C
Output Characteristics						
Output Voltage High (V_{OH})	$R_L = 100\text{k}\Omega$ to GND	+25°C	4.99	4.998		V
		Full	4.982			
	$R_L = 10\text{k}\Omega$ to GND	+25°C	4.985	4.996		
		Full	4.98			
Output Voltage Low (V_{OL})	$R_L = 100\text{k}\Omega$ to V_S	+25°C		2	10	mV
		Full			15	
	$R_L = 10\text{k}\Omega$ to V_S	+25°C		6	15	
		Full			20	
Output Short-Circuit Limit	I_{SOURCE} $R_L = 10\Omega$ to GND	+25°C	29	48		mA
		Full	19			
	I_{SINK} $R_L = 10\Omega$ to V_S	+25°C	39	48		
		Full	23			
Power Supply						
Power Supply Rejection Ratio ⁽¹⁾ (PSRR)	$V_S = 2.5\text{V}$ to 5.5V	+25°C	87	110		dB
		Full	85			
Quiescent Current/Amplifier (I_Q)	$V_{CM} = V_S/2$, $I_{OUT} = 0$	+25°C		465	650	μA
		Full			767	
Dynamic Performance						
Gain-Bandwidth Product (GBP)	$A_V = +100$	+25°C		1.5		MHz
Slew Rate (SR)	$A_V = +1$, $R_L = 10\text{k}\Omega$, 2V output step	+25°C		1		V/ μs
Overload Recovery Time	$A_V = -100$, $R_L = 10\text{k}\Omega$, $V_{IN} = 200\text{mV}$ (RET to GND)	+25°C		0.06		ms
Noise Performance						
Input Voltage Noise ($e_{n,P-P}$)	0.1Hz to 10Hz	+25°C		1.6		μV_{P-P}
Input Voltage Noise Density (e_n)	$f = 1\text{kHz}$	+25°C		63		nV/ $\sqrt{\text{Hz}}$

NOTE: 1. PSRR and CMRR are affected by the matching between external gain-setting resistor ratios.

ELECTRICAL CHARACTERISTICS (continued)(At $T_A = +25^\circ\text{C}$, $V_S = 2.5\text{V}$, $V_{CM} = 1.25\text{V}$, $V_{OUT} = 1.25\text{V}$, Full = -40°C to $+125^\circ\text{C}$, unless otherwise noted.)

PARAMETER	CONDITIONS	TEMP	MIN	TYP	MAX	UNITS
Input Characteristics						
Input Offset Voltage (V_{OS})	$V_{CM} = V_S/2$	+25°C		9	20	μV
		Full			40	
Input Bias Current (I_b)		+25°C		10		pA
Input Offset Current (I_{OS})		+25°C		10		pA
Input Voltage Range		+25°C	0		2.5	V
Common Mode Rejection Ratio ⁽¹⁾ (CMRR)	$V_{CM} = 0\text{V}$ to 2.5V	+25°C	90	105		dB
		Full	85			
Large-Signal Voltage Gain (A_{VO})	$R_L = 10\text{k}\Omega$, $V_{CM} = V_S/2$, $V_{OUT} = 0\text{V}$ to 2.5V	+25°C	100	135		dB
		Full	98			
Input Offset Voltage Drift ($\Delta V_{OS}/\Delta T$)		Full		76		nV/°C
Output Characteristics						
Output Voltage High (V_{OH})	$R_L = 100\text{k}\Omega$ to GND	+25°C	2.49	2.499		V
		Full	2.482			
	$R_L = 10\text{k}\Omega$ to GND	+25°C	2.485	2.498		
		Full	2.48			
Output Voltage Low (V_{OL})	$R_L = 100\text{k}\Omega$ to V_S	+25°C		1	10	mV
		Full			15	
	$R_L = 10\text{k}\Omega$ to V_S	+25°C		3	15	
		Full			.20	
Output Short-Circuit Limit	I_{SOURCE} $R_L = 10\Omega$ to GND	+25°C	16	28		mA
		Full	10			
	I_{SINK} $R_L = 10\Omega$ to V_S	+25°C	24	28		
		Full	12			
Power Supply						
Power Supply Rejection Ratio ⁽¹⁾ (PSRR)	$V_S = 2.5\text{V}$ to 5.5V	+25°C	87	110		dB
		Full	85			
Quiescent Current/Amplifier (I_Q)	$V_{CM} = V_S/2$, $I_{OUT} = 0$	+25°C		500	650	μA
		Full			767	
Dynamic Performance						
Gain-Bandwidth Product (GBP)	$A_V = +100$	+25°C		1.6		MHz
Slew Rate (SR)	$A_V = +1$, $R_L = 10\text{k}\Omega$, 2V output step	+25°C		1		V/ μs
Overload Recovery Time	$A_V = -100$, $R_L = 10\text{k}\Omega$, $V_{IN} = 200\text{mV}$ (RET to GND)	+25°C		0.02		ms
Noise Performance						
Input Voltage Noise ($e_{n,P-P}$)	0.1Hz to 10Hz	+25°C		1.7		μV_{P-P}
Input Voltage Noise Density (e_n)	$f = 1\text{kHz}$	+25°C		86		nV/ $\sqrt{\text{Hz}}$

NOTE: 1. PSRR and CMRR are affected by the matching between external gain-setting resistor ratios.

TYPICAL PERFORMANCE CHARACTERISTICS

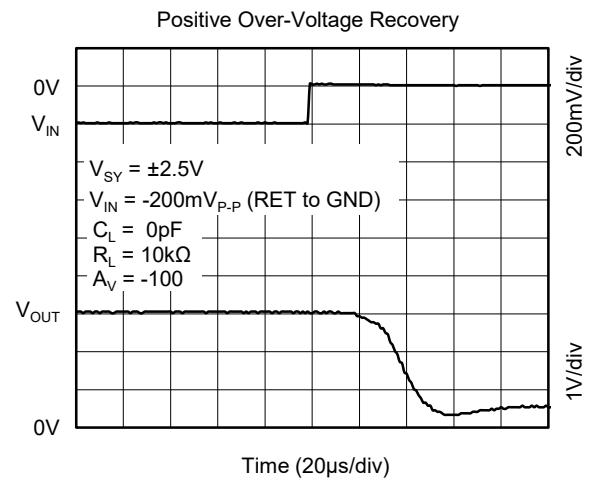
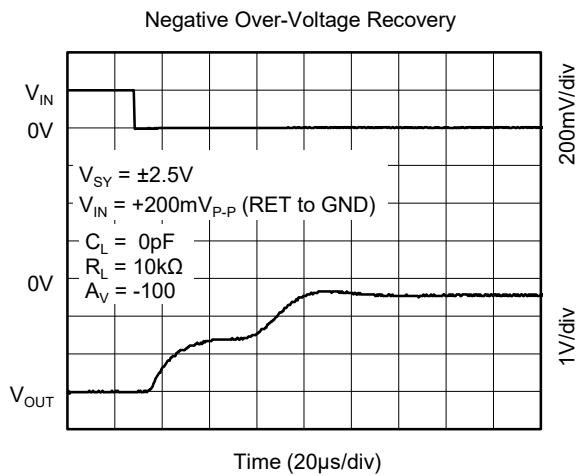
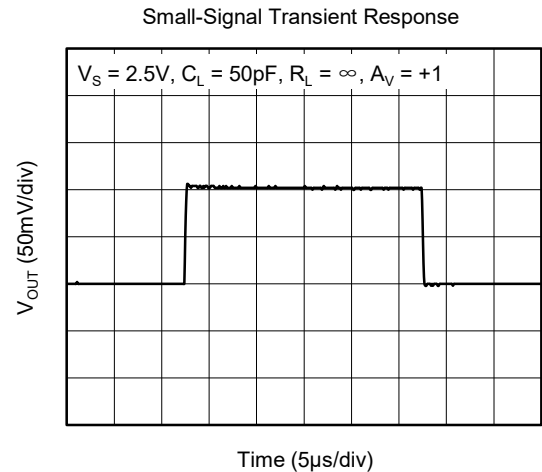
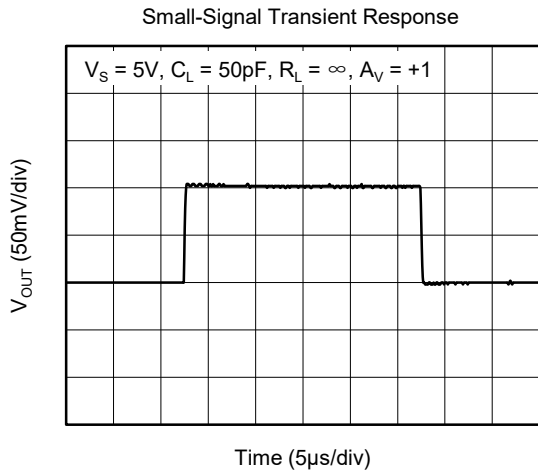
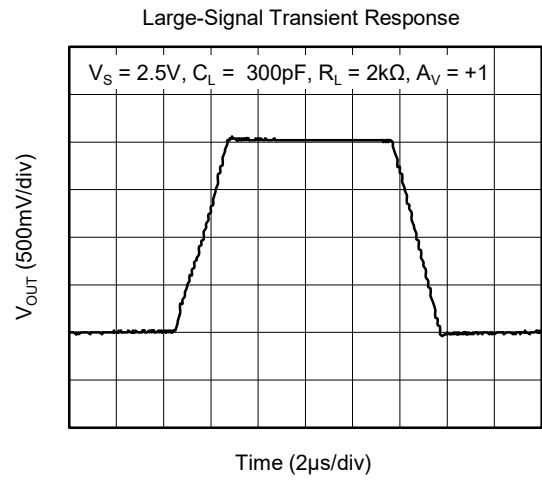
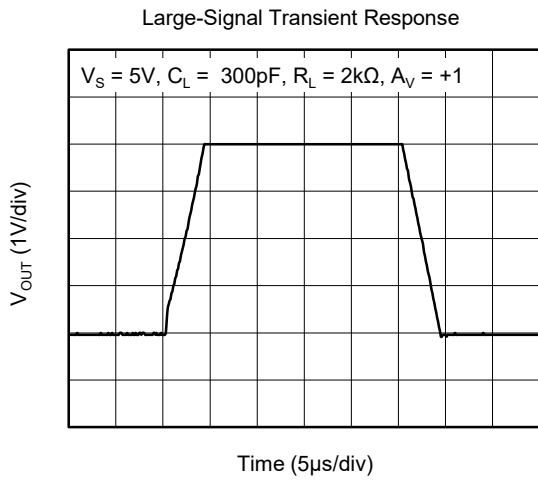

TYPICAL PERFORMANCE CHARACTERISTICS (continued)

0.1Hz to 10Hz Input Voltage Noise

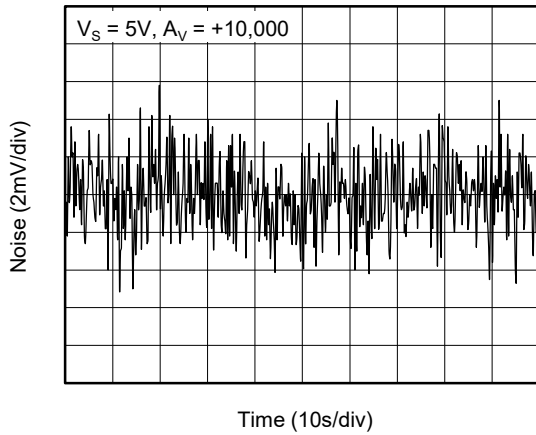

0.1Hz to 10Hz Input Voltage Noise

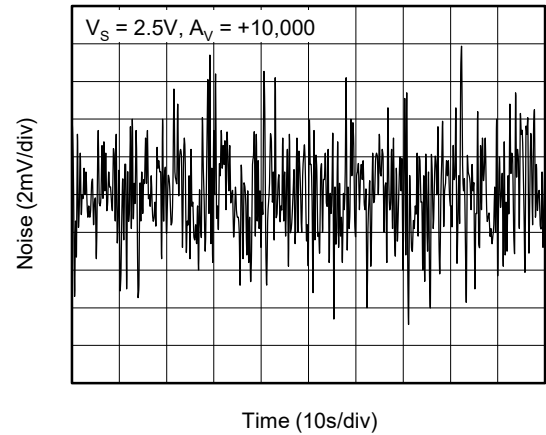

Input Voltage Noise Density vs. Frequency

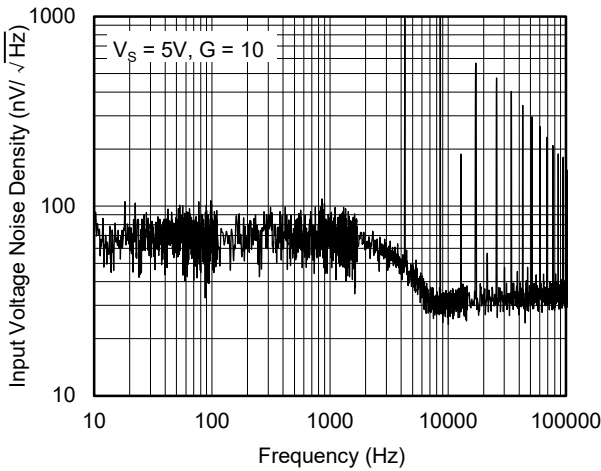

Input Voltage Noise Density vs. Frequency

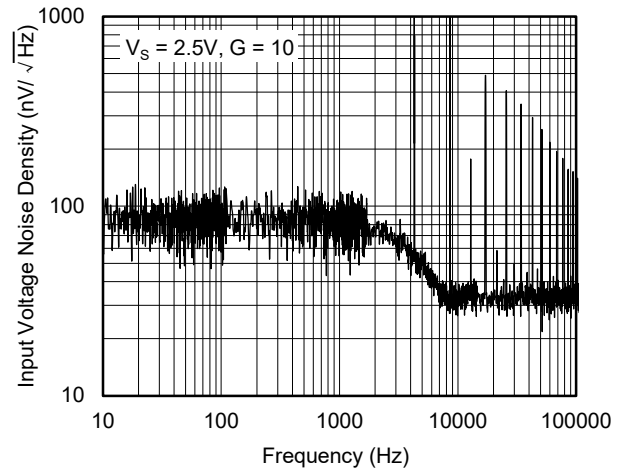

CMRR vs. Frequency

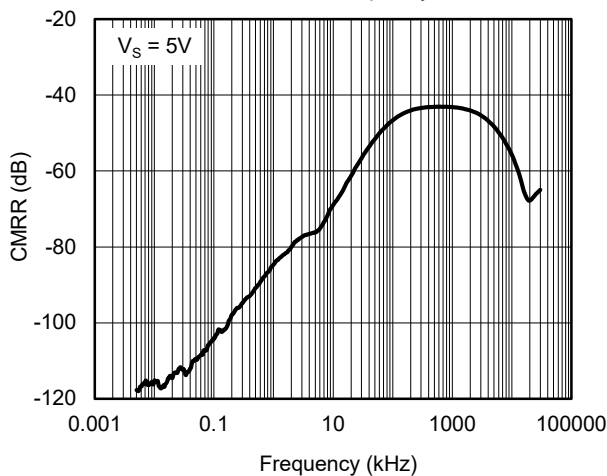

CMRR vs. Frequency

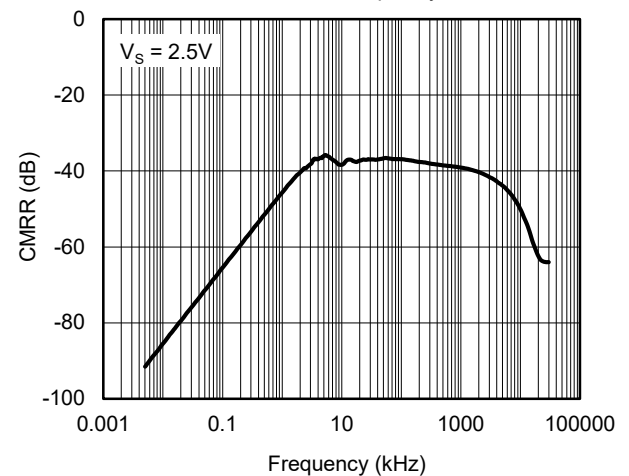

TYPICAL PERFORMANCE CHARACTERISTICS (continued)

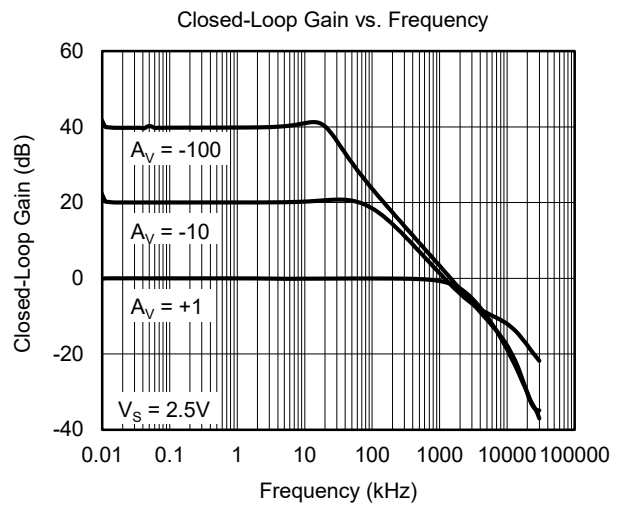
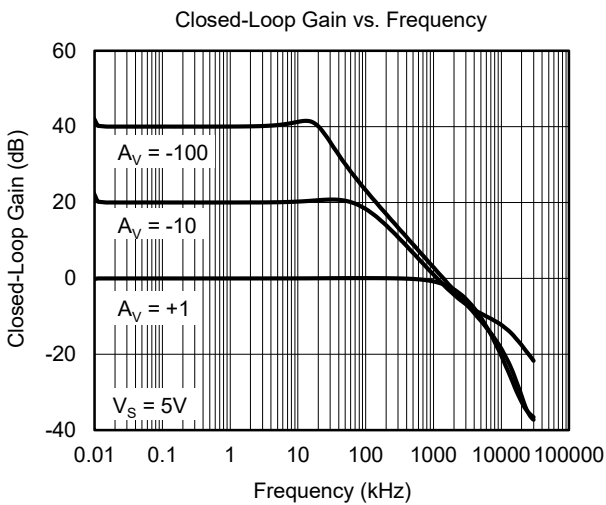
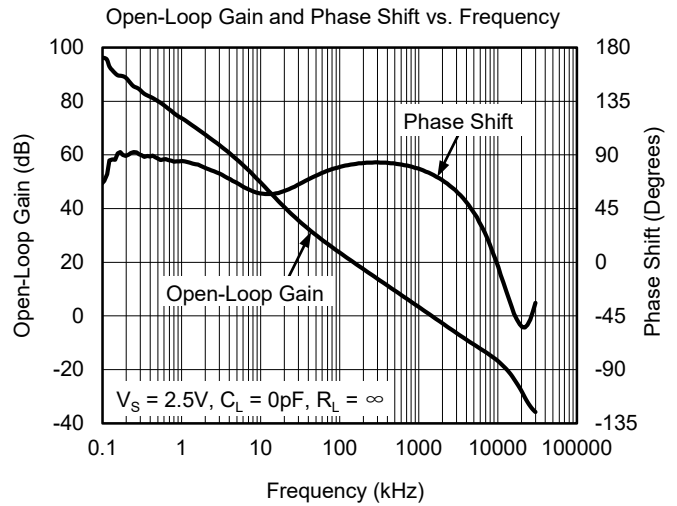
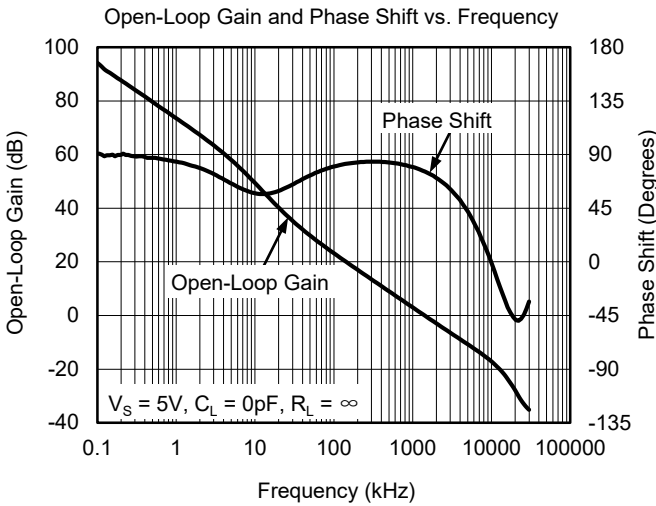
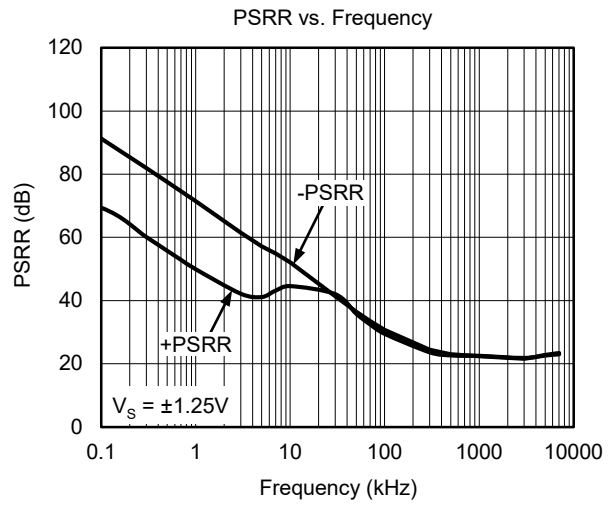
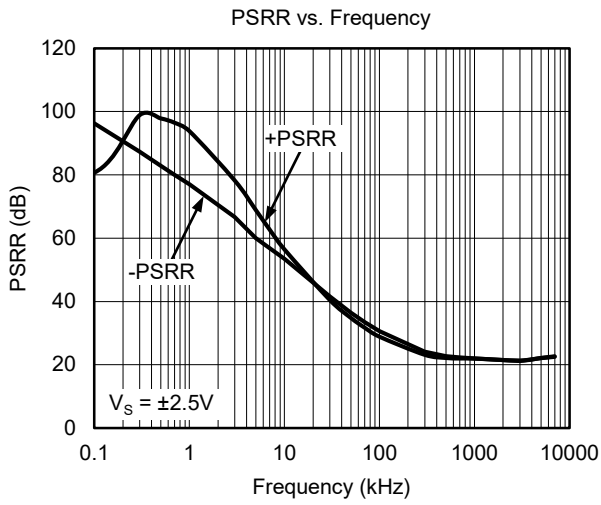

TYPICAL PERFORMANCE CHARACTERISTICS (continued)

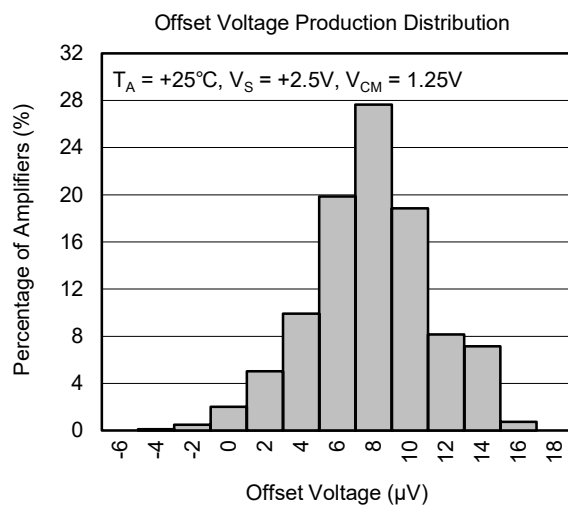
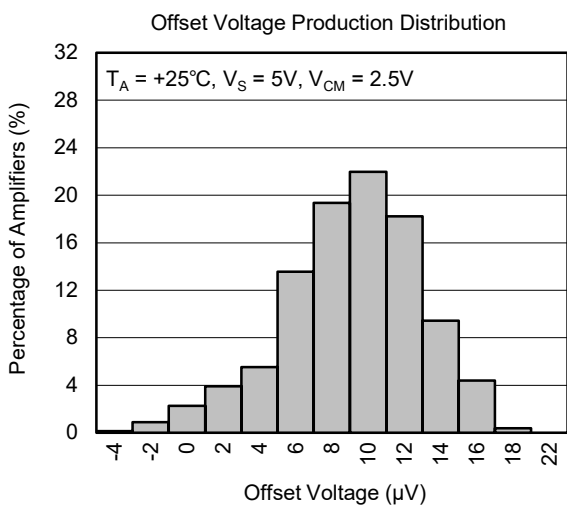

REVISION HISTORY

NOTE: Page numbers for previous revisions may differ from page numbers in the current version.

	Page
SEPTEMBER 2020 – REV.A.4 to REV.B	
Updated Electrical Characteristics section	3, 4
Updated Typical Performance Characteristics section	6, 7
JANUARY 2013 – REV.A.3 to REV.A.4	
Added Tape and Reel Information section	12, 13
DECEMBER 2011 – REV.A.2 to REV.A.3	
Changed packages' name	All
Changed Electrical Characteristics section	3, 4
Changed Typical Performance Characteristics section	7
Changed Package Outline Dimensions section	9, 10
APRIL 2010 – REV.A.1 to REV.A.2	
Changed Electrical Characteristics section	3, 4
APRIL 2010 – REV.A to REV.A.1	
Changed Typical Performance Characteristics section	8
Changes from Original (MARCH 2010) to REV.A	
Changed from product preview to production data	All

PACKAGE INFORMATION

PACKAGE OUTLINE DIMENSIONS

SOIC-14

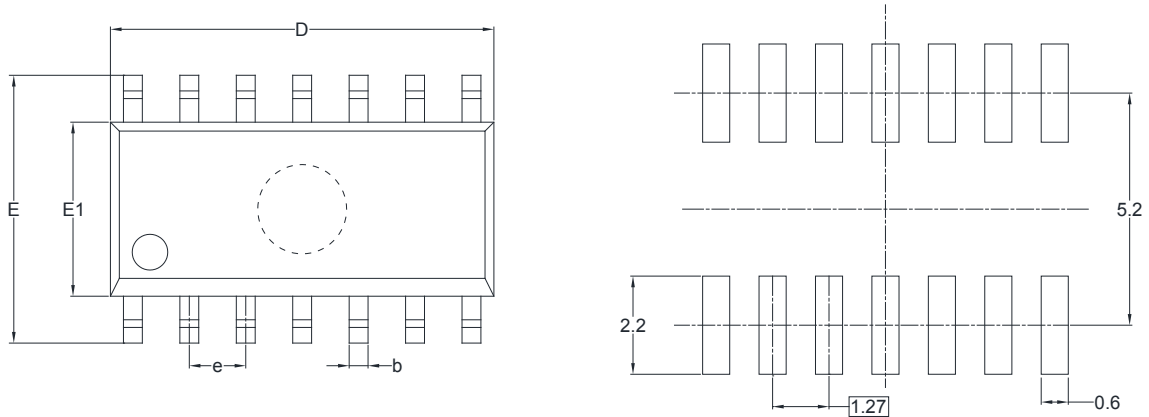

RECOMMENDED LAND PATTERN (Unit: mm)

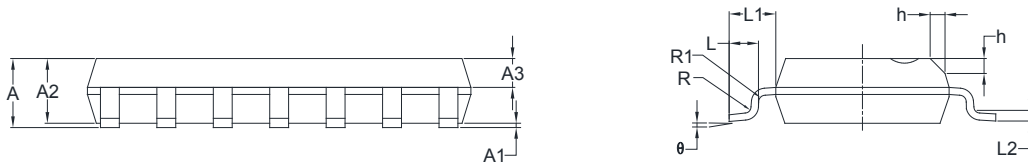

Symbol	Dimensions In Millimeters		Dimensions In Inches	
	MIN	MAX	MIN	MAX
A	1.35	1.75	0.053	0.069
A1	0.10	0.25	0.004	0.010
A2	1.25	1.65	0.049	0.065
A3	0.55	0.75	0.022	0.030
b	0.36	0.49	0.014	0.019
D	8.53	8.73	0.336	0.344
E	5.80	6.20	0.228	0.244
E1	3.80	4.00	0.150	0.157
e	1.27 BSC		0.050 BSC	
L	0.45	0.80	0.018	0.032
L1	1.04 REF		0.040 REF	
L2	0.25 BSC		0.01 BSC	
R	0.07		0.003	
R1	0.07		0.003	
h	0.30	0.50	0.012	0.020
θ	0°	8°	0°	8°

PACKAGE OUTLINE DIMENSIONS

TSSOP-14

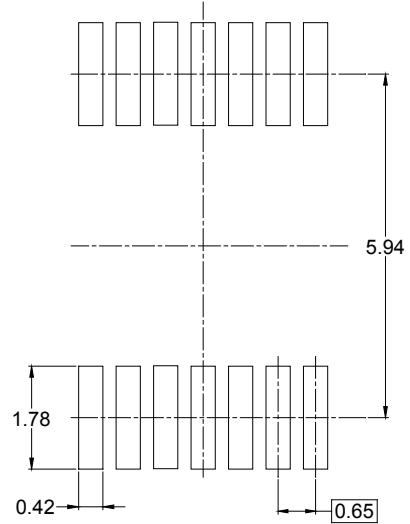
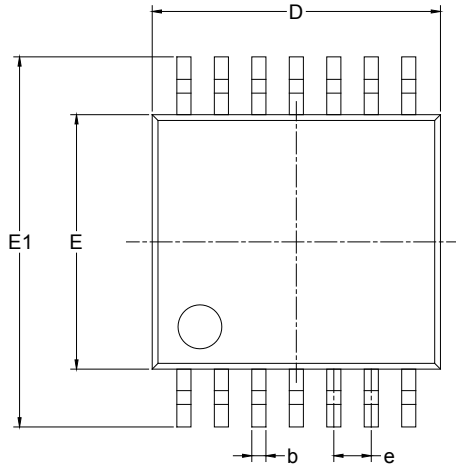

RECOMMENDED LAND PATTERN (Unit: mm)

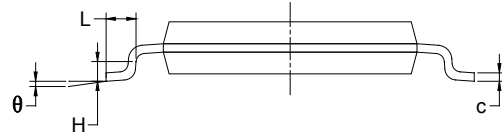
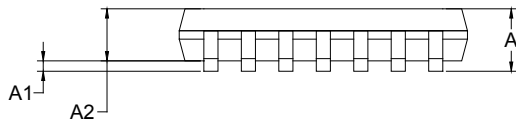

Symbol	Dimensions In Millimeters		Dimensions In Inches	
	MIN	MAX	MIN	MAX
A		1.200		0.047
A1	0.050	0.150	0.002	0.006
A2	0.800	1.050	0.031	0.041
b	0.190	0.300	0.007	0.012
c	0.090	0.200	0.004	0.008
D	4.860	5.100	0.191	0.201
E	4.300	4.500	0.169	0.177
E1	6.250	6.550	0.246	0.258
e	0.650 BSC		0.026 BSC	
L	0.500	0.700	0.02	0.028
H	0.25 TYP		0.01 TYP	
θ	1°	7°	1°	7°

PACKAGE INFORMATION

TAPE AND REEL INFORMATION

REEL DIMENSIONS

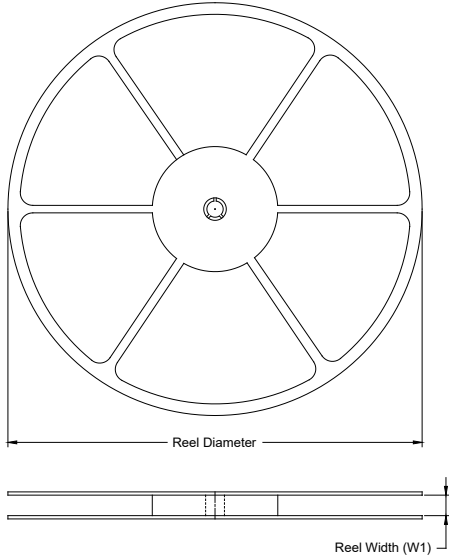

TAPE DIMENSIONS

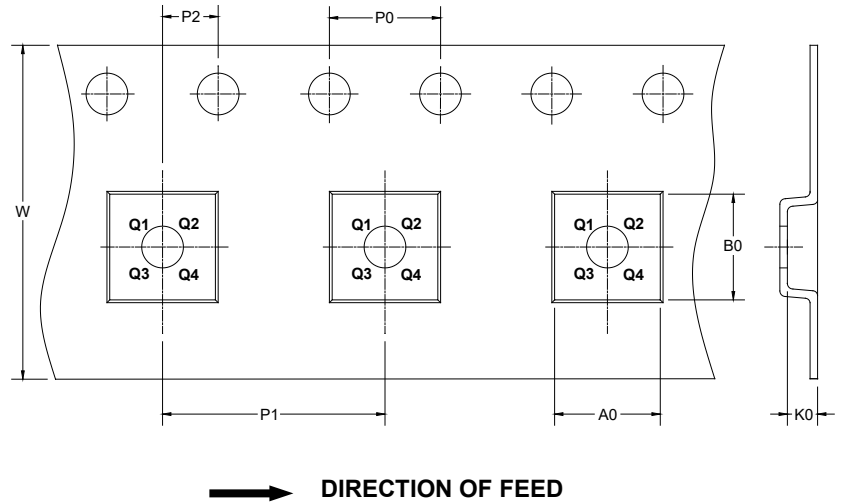

NOTE: The picture is only for reference. Please make the object as the standard.

KEY PARAMETER LIST OF TAPE AND REEL

Package Type	Reel Diameter	Reel Width W1 (mm)	A0 (mm)	B0 (mm)	K0 (mm)	P0 (mm)	P1 (mm)	P2 (mm)	W (mm)	Pin1 Quadrant
SOIC-14	13"	16.4	6.60	9.30	2.10	4.0	8.0	2.0	16.0	Q1
TSSOP-14	13"	12.4	6.95	5.60	1.20	4.0	8.0	2.0	12.0	Q1

000001

PACKAGE INFORMATION

CARTON BOX DIMENSIONS

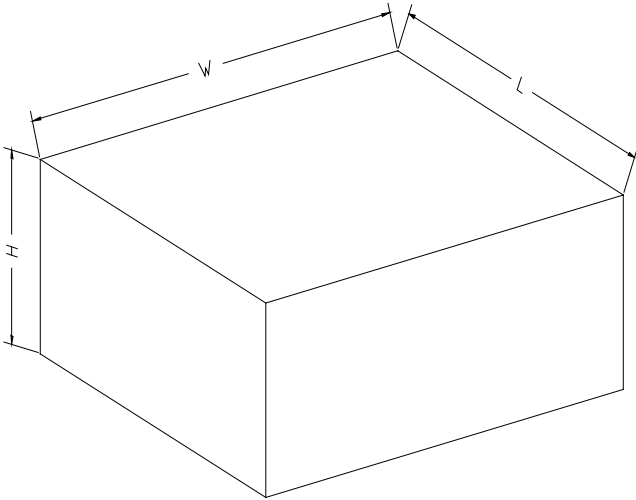

NOTE: The picture is only for reference. Please make the object as the standard.

KEY PARAMETER LIST OF CARTON BOX

Reel Type	Length (mm)	Width (mm)	Height (mm)	Pizza/Carton
13"	386	280	370	5

DD0002

单击下面可查看定价，库存，交付和生命周期等信息

[>>SGMICRO\(圣邦微电子\)](#)