



SGM6012

1.6MHz, 800mA Synchronous Step-Down Converter

GENERAL DESCRIPTION

The SGM6012 is a 1.6MHz constant frequency, current mode, synchronous, step-down switching regulator. It can deliver 800mA load current from 2.5V to 5.5V input voltage, and the output voltage can be as low as 0.6V.

The high switching frequency minimizes the sizes of inductor and capacitor. Integrated power MOSFETs and internal compensation make the SGM6012 simple to use and fit the total solution in a compact space.

The SGM6012 can operate at a low dropout for the 100% duty cycle, which can conserve the battery life of portable devices. The synchronous architecture eliminates the external Schottky diode, and achieves over 90% of the power conversion efficiency. With low output ripple voltage at light load, the 30 μ A quiescent current and less than 1 μ A shutdown current make SGM6012 the ideal power supply solution for portable applications.

SGM6012 is available in both adjustable and fixed (1.2V, 1.8V, 3.3V) output voltage versions. It is available in the Green TSOT-23-5 package. It is rated over the -40°C to +85°C temperature range.

FEATURES

- 2.5V to 5.5V Input Voltage Range
- Up to 95% High Efficiency
- 30 μ A Low Quiescent Current at Light Load
- 800mA Output Current
- 1.2V, 1.8V, 3.3V Fixed & Adjustable Output Voltages
- 0.6V Reference Voltage
- 1.6MHz Constant Switching Frequency
- Less than 1 μ A Shutdown Current
- 100% Duty Cycle for Lowest Dropout
- No External Power MOSFETs and Schottky Diode Required
- Excellent Line Regulation & Load Transient Response
- -40°C to +85°C Operating Temperature Range
- Available in a Green TSOT-23-5 Package

APPLICATIONS

GPS
Mobile Phones
E-book Readers
Digital Cameras
Portable Instruments
Wireless and DSL Modems
Battery Powered Equipment
Supply for Microprocessor, DSP

PACKAGE/ORDERING INFORMATION

MODEL	V _{OUT} (V)	PACKAGE DESCRIPTION	SPECIFIED TEMPERATURE RANGE	ORDERING NUMBER	PACKAGE MARKING	PACKING OPTION
SGM6012	1.2V	TSOT-23-5	-40°C to +85°C	SGM6012-1.2YTN5G/TR	SBFXX	Tape and Reel, 3000
	1.8V	TSOT-23-5	-40°C to +85°C	SGM6012-1.8YTN5G/TR	SH3XX	Tape and Reel, 3000
	3.3V	TSOT-23-5	-40°C to +85°C	SGM6012-3.3YTN5G/TR	SH4XX	Tape and Reel, 3000
	Adjustable	TSOT-23-5	-40°C to +85°C	SGM6012-ADJYTN5G/TR	SC0XX	Tape and Reel, 3000

MARKING INFORMATION

NOTE: XX = Date Code, Trace Code and Vendor Code.

SYX X

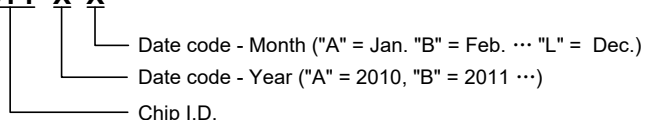

For example: SBFCA (2012, January)

Green (RoHS & HSF): SG Micro Corp defines "Green" to mean Pb-Free (RoHS compatible) and free of halogen substances. If you have additional comments or questions, please contact your SGMICRO representative directly.

ABSOLUTE MAXIMUM RATINGS

Input Supply Voltage.....	-0.3V to 6V
RUN, V _{FB} Voltages.....	-0.3V to V _{IN}
SW Voltage.....	-0.3V to (V _{IN} + 0.3V)
Package Thermal Resistance	
TSOT-23-5, θ_{JA}	200°C/W
P-Channel Switch Source Current (DC).....	800mA
N-Channel Switch Sink Current (DC).....	800mA
Peak SW Sink and Source Current.....	1.3A
Operating Temperature Range.....	-40°C to +85°C
Junction Temperature.....	150°C
Storage Temperature Range.....	-65°C to +150°C
Lead Temperature (Soldering, 10s)	260°C
ESD Susceptibility	
HBM.....	4000V
MM.....	300V

RECOMMENDED OPERATING CONDITIONS

Operating Temperature Range -40°C to +85°C

OVERSTRESS CAUTION

Stresses beyond those listed in Absolute Maximum Ratings may cause permanent damage to the device. Exposure to absolute maximum rating conditions for extended periods may affect reliability. Functional operation of the device at any conditions beyond those indicated in the Recommended Operating Conditions section is not implied.

ESD SENSITIVITY CAUTION

This integrated circuit can be damaged if ESD protections are not considered carefully. SGMICRO recommends that all integrated circuits be handled with appropriate precautions. Failure to observe proper handling and installation procedures can cause damage. ESD damage can range from subtle performance degradation to complete device failure. Precision integrated circuits may be more susceptible to damage because even small parametric changes could cause the device not to meet the published specifications.

DISCLAIMER

SG Micro Corp reserves the right to make any change in circuit design, or specifications without prior notice.

PIN CONFIGURATION

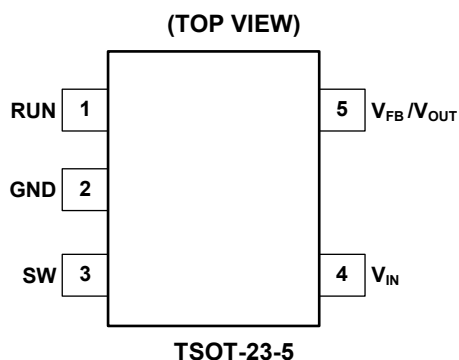

PIN DESCRIPTION

PIN	NAME	FUNCTION
1	RUN	Control Input. More than 1.5V input enables the device. Less than 0.3V input shuts down the device. In shutdown, all functions stopped with the drawing supply current less than 1 μ A. Do not leave it floating.
2	GND	Ground.
3	SW	Switch Node. Put an inductor to this pin and connect to the drains of the internal main and synchronous power MOSFET switches.
4	V _{IN}	Supply Voltage Pin. A 4.7 μ F ceramic capacitor or greater is used to decouple this pin to GND closely.
5	V _{FB}	Feedback Pin. This pin receives the feedback voltage from an external resistive divider across the output. For adjustable version, the internal voltage divider is disabled. (SGM6012-ADJ)

ELECTRICAL CHARACTERISTICS

($V_{IN} = 3.6V$, $L = 2.2\mu H$, $C_{IN} = 4.7\mu F$, $C_{OUT} = 10\mu F$, Full = $-40^{\circ}C$ to $+85^{\circ}C$, typical values are at $T_A = +25^{\circ}C$, unless otherwise noted.)

PARAMETER		SYMBOL	CONDITIONS	TEMP	MIN	TYP	MAX	UNITS		
Input Voltage Range		V_{IN}		Full	2.5		5.5	V		
Feedback Current		I_{VFB}		Full		± 1	± 100	nA		
Regulated Feedback Voltage		V_{FB}		Full	0.580	0.600	0.622	V		
				$+25^{\circ}C$	0.583	0.600	0.620			
				$0^{\circ}C \leq T_A \leq +85^{\circ}C$	0.582	0.600	0.621			
Reference Voltage Line Regulation		ΔV_{FB}	$V_{IN} = 2.5V$ to $5.5V$	Full		0.1	0.6	%/V		
Regulated Output Voltage		V_{OUT}	SGM6012-1.2	Full				V		
			$I_{OUT} = 100mA$							
			SGM6012-1.8						$I_{OUT} = 100mA$	1.159
Regulated Output Voltage		V_{OUT}	SGM6012-3.3	Full				V		
			$I_{OUT} = 100mA$						1.739	1.800
Output Voltage Line Regulation		ΔV_{OUT}	$V_{IN} = 2.5V$ to $5.5V$	Full		0.1	0.6	%/V		
Peak Inductor Current		I_{PK}	$V_{FB} = 0.5V$ or $V_{OUT} = 90\%$, $V_{IN} = 3V$	$+25^{\circ}C$		1	1.25	A		
Output Voltage Load Regulation		$V_{LOADREG}$		$+25^{\circ}C$		0.5		%		
SW Leakage Current		I_{SW}	$V_{RUN} = 0V$, $V_{SW} = 0V$ or $5V$, $V_{IN} = 5V$	$+25^{\circ}C$		± 0.01	± 1	μA		
Supply Current	PWM Mode	I_S	$V_{FB} = 0.5V$ or $V_{OUT} = 90\%$, $I_{LOAD} = 0A$	$+25^{\circ}C$				μA		
	PFM Mode		$V_{FB} = 0.62V$ or $V_{OUT} = 103\%$, $I_{LOAD} = 0A$						280	360
	Shutdown		$V_{RUN} = 0V$, $V_{IN} = 4.2V$						30	56
RUN Threshold		V_{IH}		Full	1.5			V		
		V_{IL}							0.3	
RUN Leakage Current		I_{RUN}		Full		± 0.01	± 1	μA		
Oscillator Frequency		f_{OSC}	$V_{FB} = 0.6V$ or $V_{OUT} = 100\%$	Full	1.3	1.6	1.9	MHz		
			$V_{FB} = 0V$ or $V_{OUT} = 0V$	$+25^{\circ}C$		200		kHz		
R _{DS(ON)} of P-Channel FET		R_{PFET}	$I_{SW} = 100mA$	$+25^{\circ}C$		0.46	0.65	Ω		
R _{DS(ON)} of N-Channel FET		R_{NFET}	$I_{SW} = -100mA$	$+25^{\circ}C$		0.36	0.56	Ω		
PFM/PWM Mode Switch Point				$+25^{\circ}C$		40		mA		

TYPICAL PERFORMANCE CHARACTERISTICS

T_A = +25°C, L = 2.2µH, C_{IN} = 4.7µF, C_{OUT} = 10µF, unless otherwise noted.

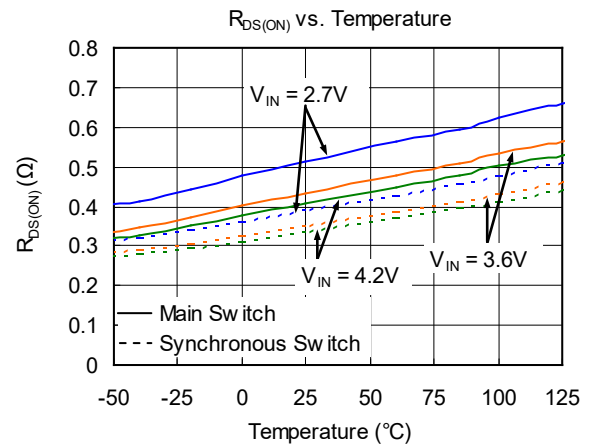
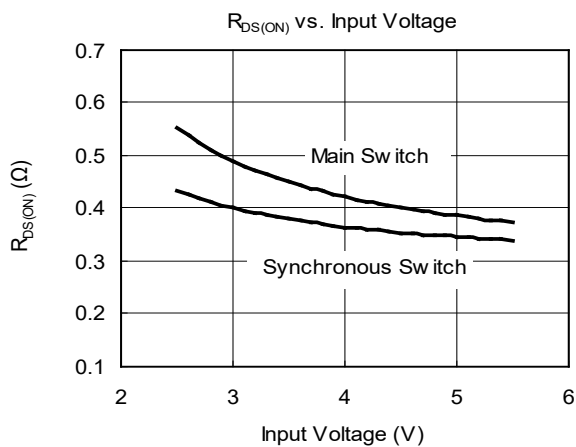
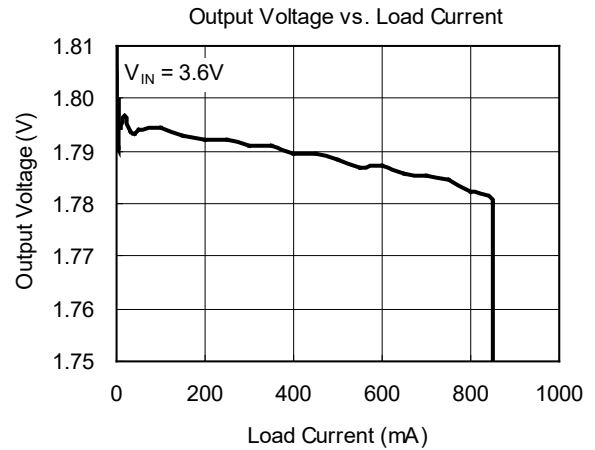
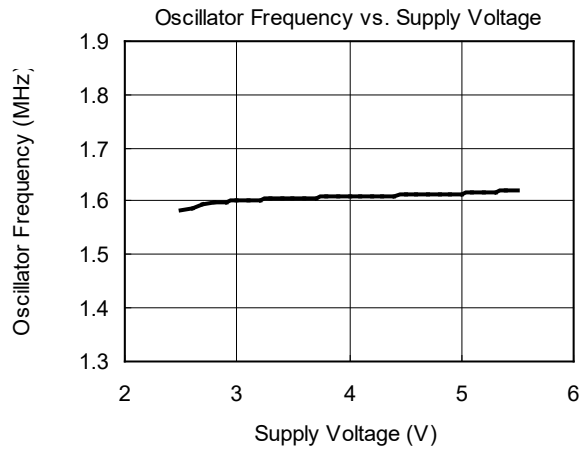
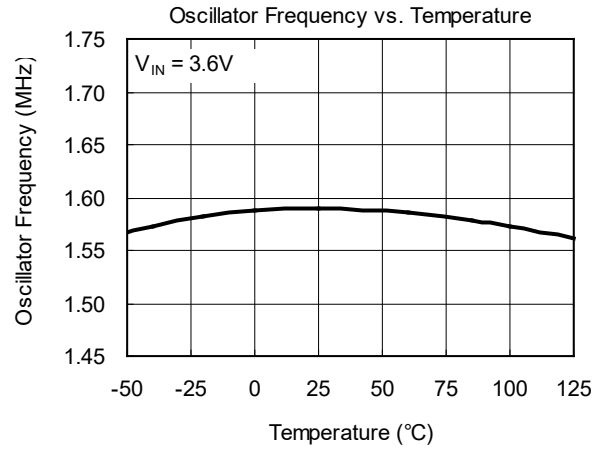
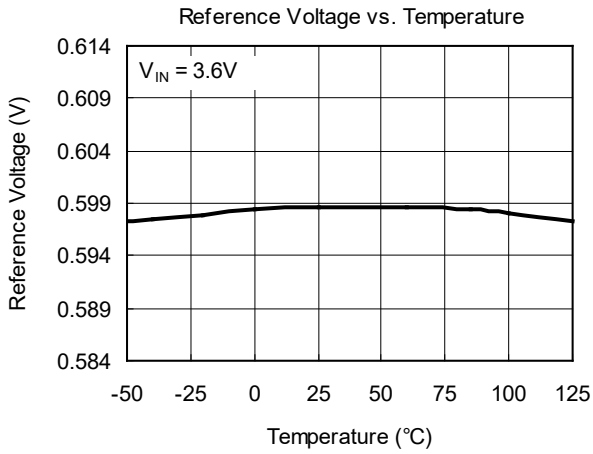

TYPICAL PERFORMANCE CHARACTERISTICS (continued)

$T_A = +25^\circ\text{C}$, $L = 2.2\mu\text{H}$, $C_{IN} = 4.7\mu\text{F}$, $C_{OUT} = 10\mu\text{F}$, unless otherwise noted.

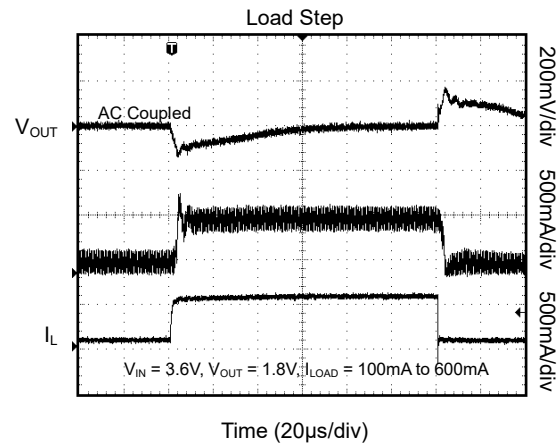
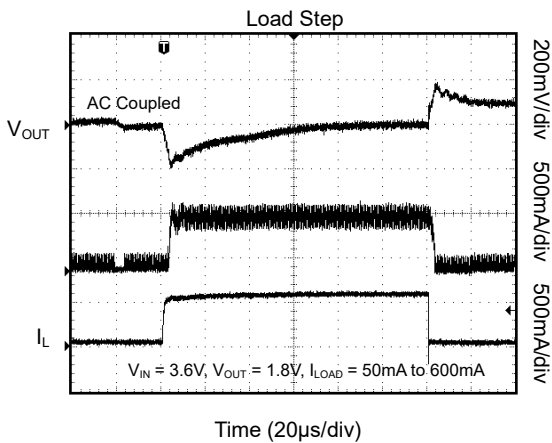
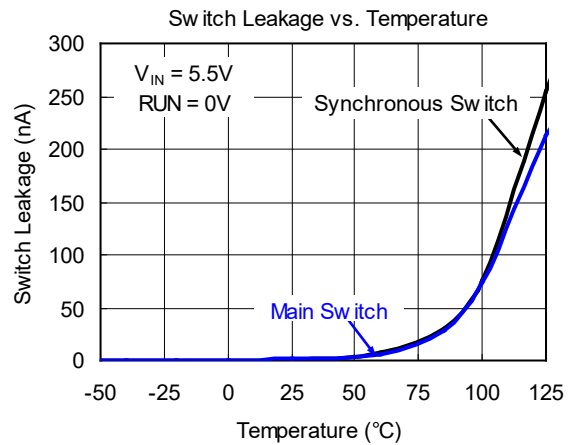
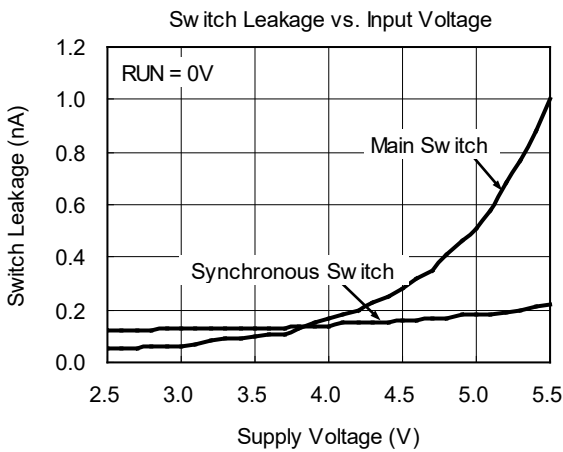
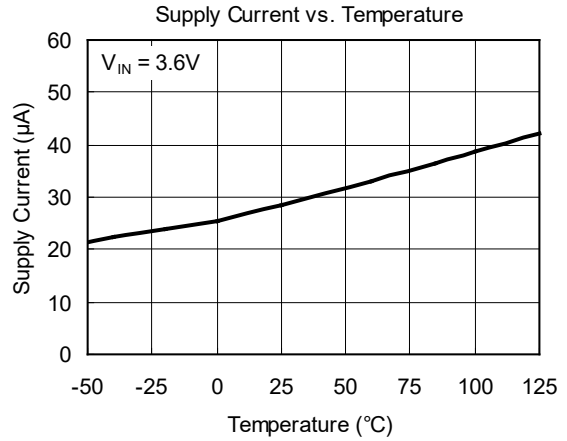
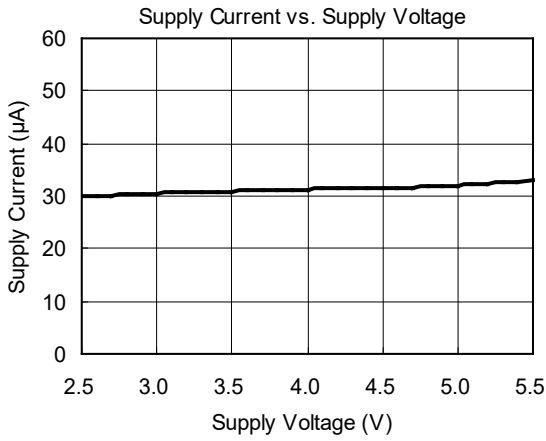

TYPICAL PERFORMANCE CHARACTERISTICS (continued)

$T_A = +25^\circ\text{C}$, $L = 2.2\mu\text{H}$, $C_{IN} = 4.7\mu\text{F}$, $C_{OUT} = 10\mu\text{F}$, unless otherwise noted.

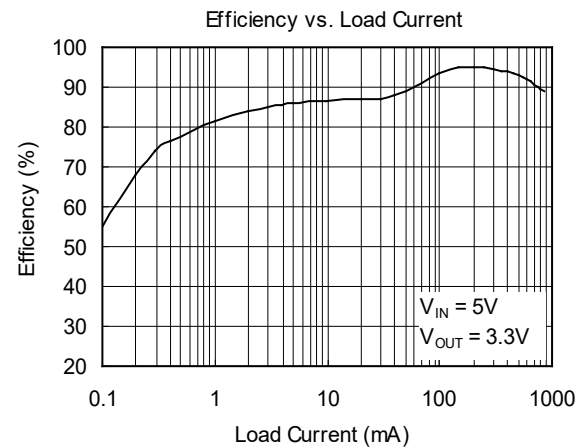
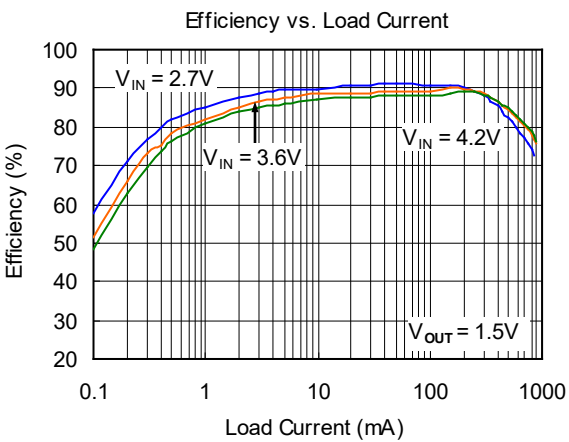
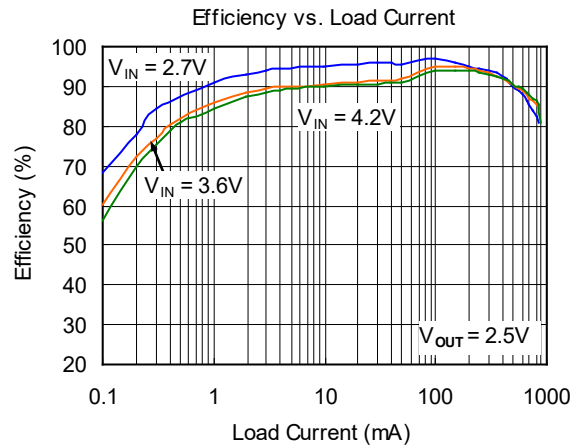
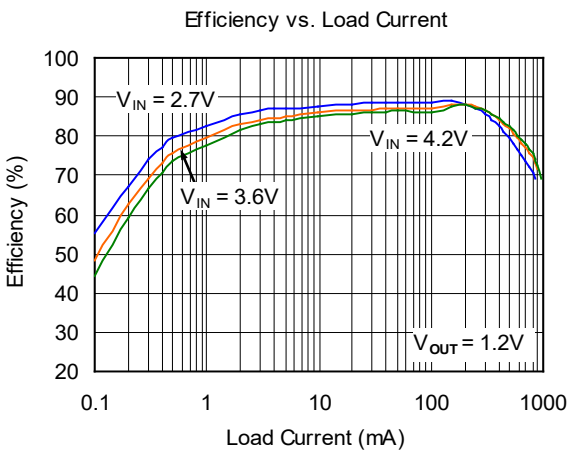
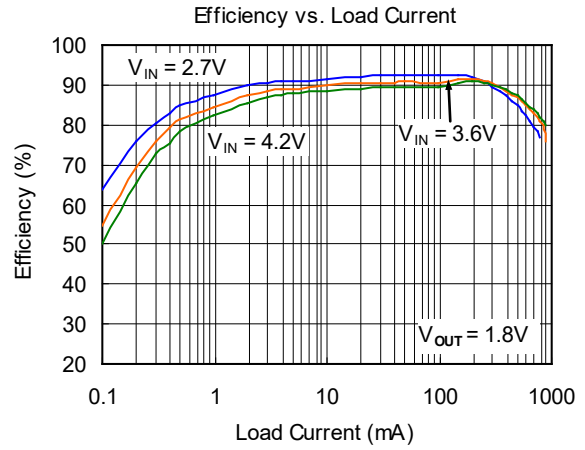
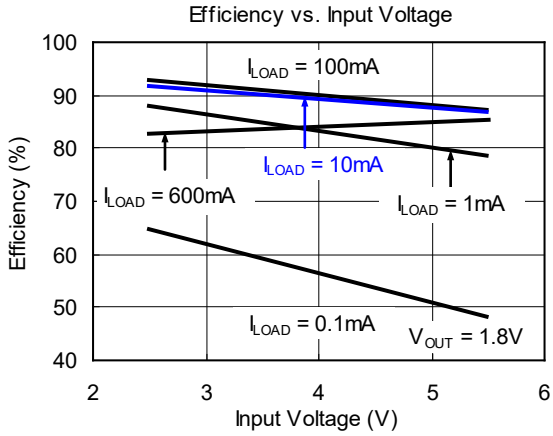

TYPICAL PERFORMANCE CHARACTERISTICS (continued)

$T_A = +25^\circ\text{C}$, $L = 2.2\mu\text{H}$, $C_{IN} = 4.7\mu\text{F}$, $C_{OUT} = 10\mu\text{F}$, unless otherwise noted.

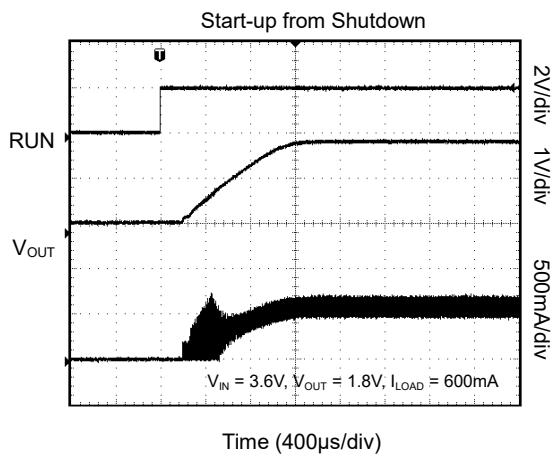
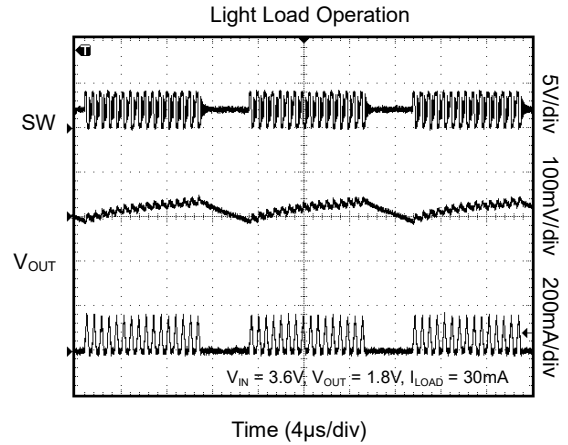
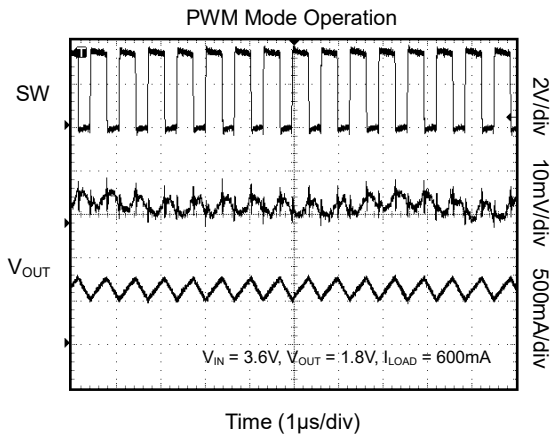

PCB LAYOUT

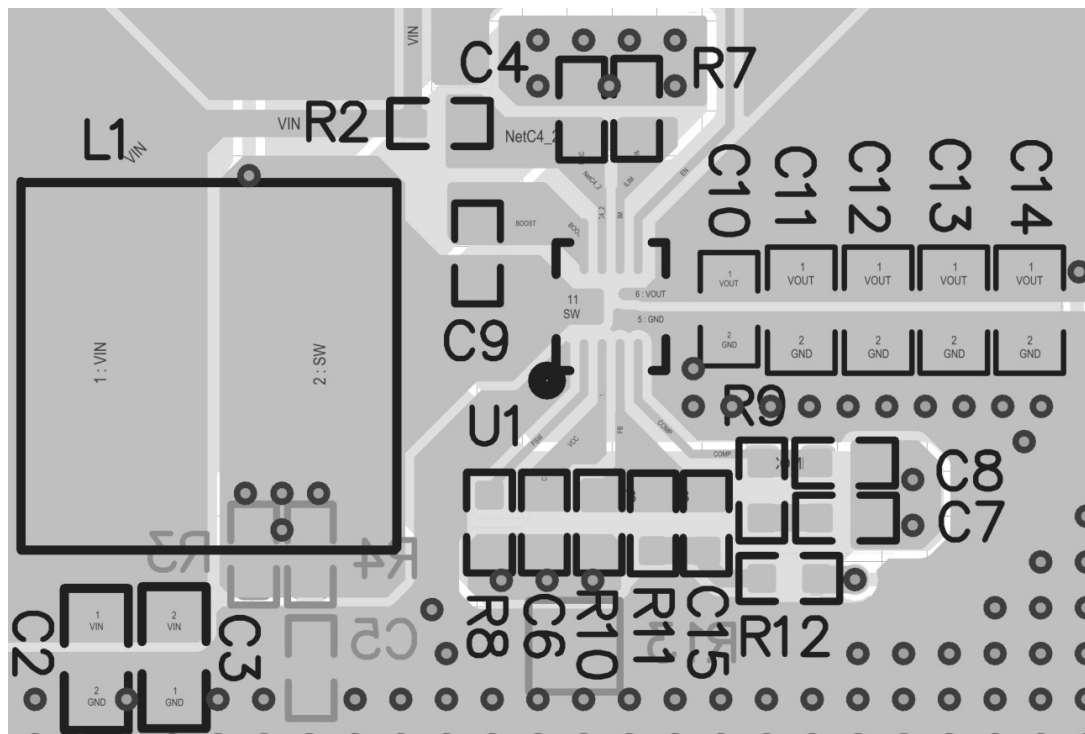

Figure 1. Layout Example

REVISION HISTORY

NOTE: Page numbers for previous revisions may differ from page numbers in the current version.

MARCH 2016 – REV.A to REV.A.1	Page
Updated Electrical Characteristics section	4
Changed load current (600mA to 800mA).....	All

Changes from Original (DECEMBER 2012) to REV.A	Page
Changed from product preview to production data.....	All

PACKAGE OUTLINE DIMENSIONS

TSOT-23-5

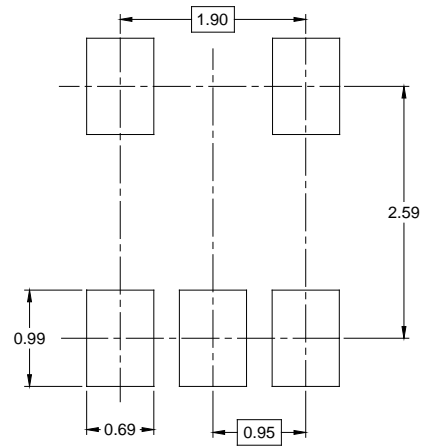
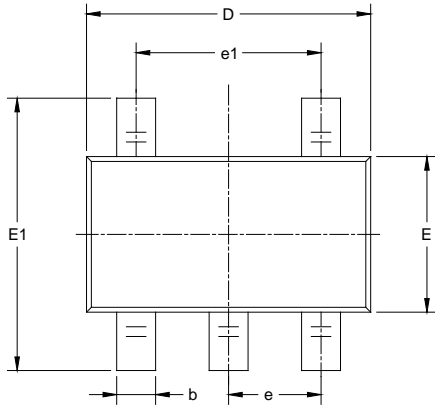

RECOMMENDED LAND PATTERN (Unit: mm)

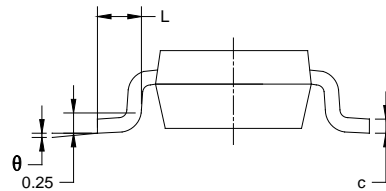
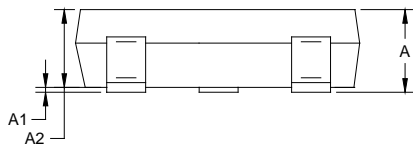

Symbol	Dimensions In Millimeters		Dimensions In Inches	
	MIN	MAX	MIN	MAX
A	0.700	0.900	0.028	0.035
A1	0.000	0.100	0.000	0.004
A2	0.700	0.800	0.028	0.031
b	0.350	0.500	0.014	0.020
c	0.080	0.200	0.003	0.008
D	2.820	3.020	0.111	0.119
E	1.600	1.700	0.063	0.067
E1	2.650	2.950	0.104	0.116
e	0.950 BSC		0.037 BSC	
e1	1.900 BSC		0.075 BSC	
L	0.300	0.600	0.012	0.024
θ	0°	8°	0°	8°

NOTES:

1. Body dimensions do not include mode flash or protrusion.
2. This drawing is subject to change without notice.

PACKAGE INFORMATION

TAPE AND REEL INFORMATION

REEL DIMENSIONS

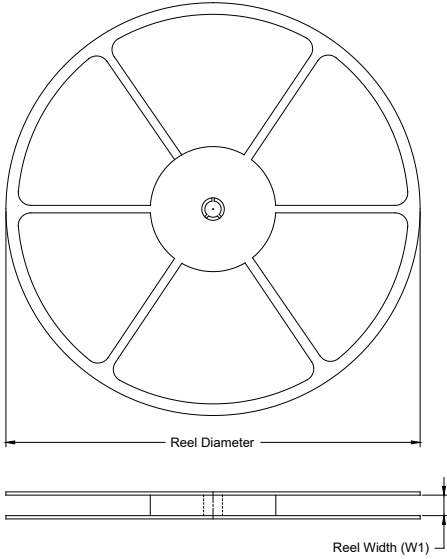

TAPE DIMENSIONS

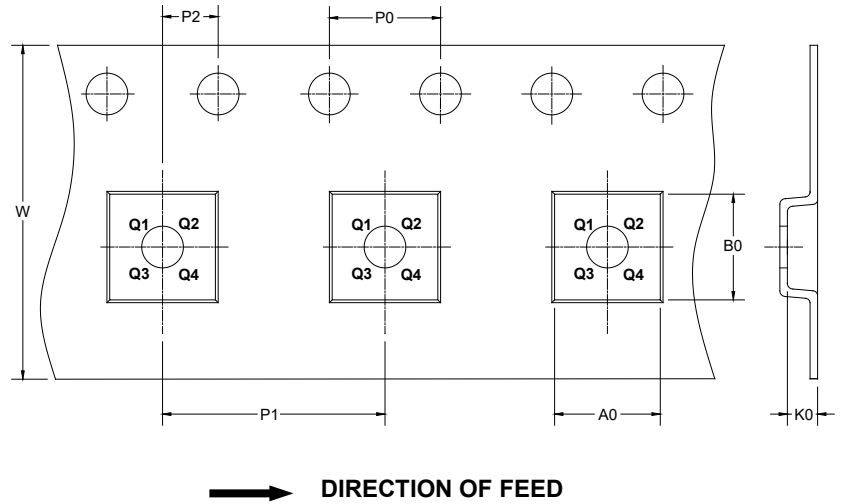

NOTE: The picture is only for reference. Please make the object as the standard.

KEY PARAMETER LIST OF TAPE AND REEL

Package Type	Reel Diameter	Reel Width W1 (mm)	A0 (mm)	B0 (mm)	K0 (mm)	P0 (mm)	P1 (mm)	P2 (mm)	W (mm)	Pin1 Quadrant
TSOT-23-5	7"	9.5	3.17	3.10	1.10	4.0	4.0	2.0	8.0	Q3

000001

PACKAGE INFORMATION

CARTON BOX DIMENSIONS

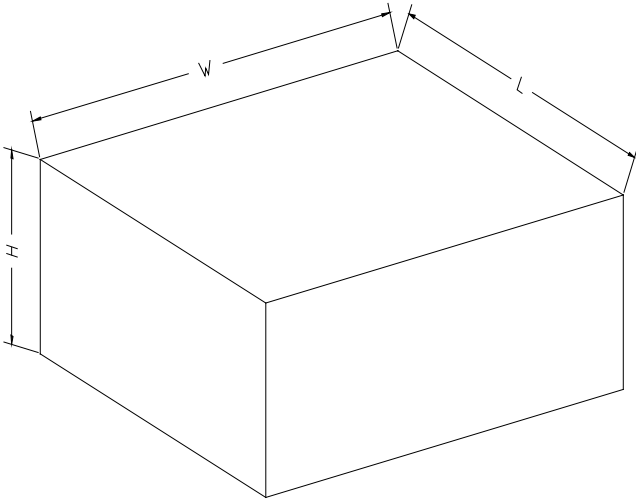

NOTE: The picture is only for reference. Please make the object as the standard.

KEY PARAMETER LIST OF CARTON BOX

Reel Type	Length (mm)	Width (mm)	Height (mm)	Pizza/Carton
7" (Option)	368	227	224	8
7"	442	410	224	18

DD0002

单击下面可查看定价，库存，交付和生命周期等信息

[>>SGMICRO\(圣邦微电子\)](#)