

GENERAL DESCRIPTION

The 74LVC1G125 is a single buffer/line driver with a non-inverting 3-state output and it is designed for 1.65V to 5.5V V_{CC} operation. The 3-state output is controlled by the output enable input (\overline{OE}). When \overline{OE} is low, the device passes data from the A input to the Y output. When \overline{OE} is high, the output is in the high-impedance state. The input from 3.3V or 5V device makes this device to operate in a mixed 3.3V and 5V system environment.

This device is highly suitable for partial power-down applications using power-off leakage current (I_{OFF}) circuit. When the device is powered down, the current backflow will be prevented from passing through the device.

FEATURES

- **Wide Operating Voltage Range: 1.65V to 5.5V**
- **Inputs Accept Voltages up to 5V**
- **+24mA/-24mA Output Current at $V_{CC} = 3.0V$**
- **CMOS Low Power Dissipation**
- **Direct Interface with TTL Levels**
- **High Noise Immunity**
- **Latch-up Performance Exceeds 250mA**
- **-40°C to +125°C Operating Temperature Range**
- **Available in Green SC70-5 and SOT-23-5 Packages**

LOGIC SYMBOL

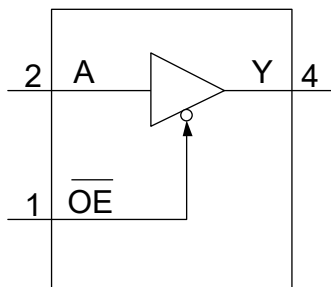

FUNCTION TABLE

INPUT		OUTPUT
\overline{OE}	A	Y
L	L	L
L	H	H
H	X	Z

H = High Voltage Level
 L = Low Voltage Level
 Z = High-Impedance State
 X = Don't Care

LOGIC DIAGRAM

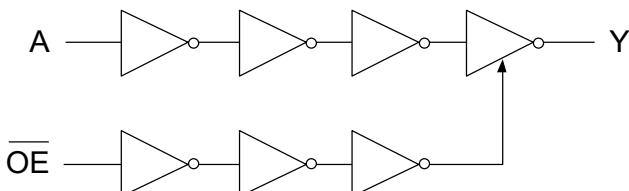

74LVC1G125

PACKAGE/ORDERING INFORMATION

MODEL	PACKAGE DESCRIPTION	SPECIFIED TEMPERATURE RANGE	ORDERING NUMBER	PACKAGE MARKING	PACKING OPTION
74LVC1G125	SC70-5	-40°C to +125°C	74LVC1G125XC5G/TR	R56XX	Tape and Reel, 3000
	SOT-23-5	-40°C to +125°C	74LVC1G125XN5G/TR	MEZXX	Tape and Reel, 3000

MARKING INFORMATION

NOTE: XX = Date Code.

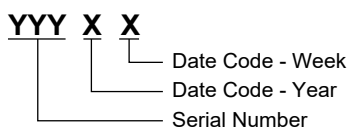

Green (RoHS & HSF): SG Micro Corp defines "Green" to mean Pb-Free (RoHS compatible) and free of halogen substances. If you have additional comments or questions, please contact your SGMICRO representative directly.

ABSOLUTE MAXIMUM RATINGS ⁽¹⁾

Supply Voltage, V_{CC}	-0.5V to 6.5V
Input Voltage, V_I ⁽²⁾	-0.5V to 6.5V
Output Voltage, V_O ⁽²⁾⁽³⁾	
Active Mode.....	-0.5V to $V_{CC} + 0.5V$
Power-Down Mode.....	-0.5 to 6.5V
Input Clamping Current, I_{IK} ($V_I < 0V$).....	-50mA
Output Clamping Current, I_{OK} ($V_O > V_{CC}$ or $V_O < 0V$).....	$\pm 50mA$
Output Current, I_O ($V_O = 0V$ to V_{CC}).....	
High-State or Low-State.....	$\pm 50mA$
Supply Current, I_{CC}	50mA
Ground Current, I_{GND}	-50mA
Package Thermal Resistance	
SC70-5, θ_{JA}	346°C/W
SOT-23-5, θ_{JA}	323°C/W
Junction Temperature ⁽⁴⁾	+150°C
Storage Temperature Range.....	-65°C to +150°C
Lead Temperature (Soldering, 10s).....	+260°C
ESD Susceptibility	
HBM.....	6000V
CDM.....	1000V

RECOMMENDED OPERATING CONDITIONS

Supply Voltage, V_{CC}	1.65V to 5.5V
Input Voltage, V_I	0V to 5.5V
Output Voltage, V_O	
Active Mode.....	0V to V_{CC}
Power-Down Mode, $V_{CC} = 0V$	0V to 5.5V
Input Transition Rise and Fall Rate, $\Delta t/\Delta V$	
$V_{CC} = 1.65V$ to $2.7V$	20ns/V (MAX)
$V_{CC} = 2.7V$ to $5.5V$	10ns/V (MAX)
Operating Temperature Range.....	-40°C to +125°C

OVERSTRESS CAUTION

1. Stresses beyond those listed in Absolute Maximum Ratings may cause permanent damage to the device. Exposure to absolute maximum rating conditions for extended periods may affect reliability. Functional operation of the device at any conditions beyond those indicated in the Recommended Operating Conditions section is not implied.
2. The input and output voltage ratings may be exceeded if the input and output clamp current ratings are observed.
3. The V_O can reach 5.5V in normal operation when $V_{CC} = 0V$.
4. The performance capability of a high-performance integrated circuit in conjunction with its thermal environment can create junction temperatures which are detrimental to reliability.

ESD SENSITIVITY CAUTION

This integrated circuit can be damaged if ESD protections are not considered carefully. SGMICRO recommends that all integrated circuits be handled with appropriate precautions. Failure to observe proper handling and installation procedures can cause damage. ESD damage can range from subtle performance degradation to complete device failure. Precision integrated circuits may be more susceptible to damage because even small parametric changes could cause the device not to meet the published specifications.

DISCLAIMER

SG Micro Corp reserves the right to make any change in circuit design, or specifications without prior notice.

PIN CONFIGURATIONS

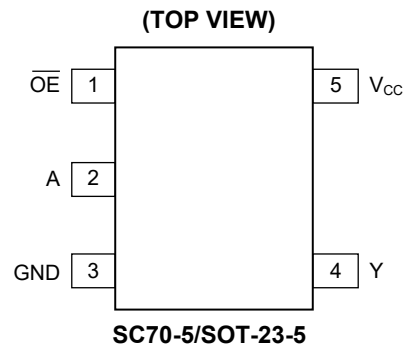

PIN DESCRIPTION

PIN	NAME	FUNCTION
1	\overline{OE}	Output Enable Input.
2	A	Data Input.
3	GND	Ground.
4	Y	Data Output.
5	V _{CC}	Supply Voltage.

ELECTRICAL CHARACTERISTICS(Full = -40°C to +125°C, all typical values are measured at $V_{CC} = 3.3V$ and $T_A = +25^\circ C$, unless otherwise noted.)

PARAMETER	SYMBOL	CONDITIONS	TEMP	MIN	TYP	MAX	UNITS	
High-Level Input Voltage	V_{IH}	$V_{CC} = 1.65V$ to $1.95V$	Full	$0.68 \times V_{CC}$			V	
		$V_{CC} = 2.3V$ to $2.7V$	Full	1.7				
		$V_{CC} = 2.7V$ to $3.6V$	Full	2.0				
		$V_{CC} = 4.5V$ to $5.5V$	Full	$0.7 \times V_{CC}$				
Low-Level Input Voltage	V_{IL}	$V_{CC} = 1.65V$ to $1.95V$	Full			$0.35 \times V_{CC}$	V	
		$V_{CC} = 2.3V$ to $2.7V$	Full			0.7		
		$V_{CC} = 2.7V$ to $3.6V$	Full			0.8		
		$V_{CC} = 4.5V$ to $5.5V$	Full			$0.3 \times V_{CC}$		
High-Level Output Voltage	V_{OH}	$V_I = V_{IH}$	$V_{CC} = 1.65V$ to $5.5V$, $I_O = -100\mu A$	Full	$V_{CC} - 0.05$	$V_{CC} - 0.01$	V	
			$V_{CC} = 1.65V$, $I_O = -4mA$	Full	1.43	1.55		
			$V_{CC} = 2.3V$, $I_O = -8mA$	Full	2.02	2.18		
			$V_{CC} = 2.7V$, $I_O = -12mA$	Full	2.38	2.56		
			$V_{CC} = 3.0V$, $I_O = -24mA$	Full	2.52	2.74		
			$V_{CC} = 4.5V$, $I_O = -32mA$	Full	4.00	4.22		
Low-Level Output Voltage	V_{OL}	$V_I = V_{IL}$	$V_{CC} = 1.65V$ to $5.5V$, $I_O = 100\mu A$	Full		0.01	0.05	V
			$V_{CC} = 1.65V$, $I_O = 4mA$	Full		0.10	0.22	
			$V_{CC} = 2.3V$, $I_O = 8mA$	Full		0.12	0.28	
			$V_{CC} = 2.7V$, $I_O = 12mA$	Full		0.16	0.34	
			$V_{CC} = 3.0V$, $I_O = 24mA$	Full		0.30	0.56	
			$V_{CC} = 4.5V$, $I_O = 32mA$	Full		0.32	0.60	
Input Leakage Current	I_I	$V_{CC} = 0V$ to $5.5V$, $V_I = 5.5V$ or GND	Full		± 0.01	± 1	μA	
Off-State Output Current	I_{OZ}	$V_{CC} = 3.6V$, $V_I = V_{IH}$ or V_{IL} , $V_O = 5.5V$ or GND	Full		± 0.01	± 1	μA	
Power-Off Leakage Current	I_{OFF}	$V_{CC} = 0V$, V_I or $V_O = 5.5V$	Full		± 0.01	± 1	μA	
Supply Current	I_{CC}	$V_{CC} = 1.65V$ to $5.5V$, $V_I = 5.5V$ or GND, $I_O = 0A$	Full		0.01	1	μA	
Additional Supply Current	ΔI_{CC}	Per pin, $V_{CC} = 2.3V$ to $5.5V$, $V_I = V_{CC} - 0.6V$, $I_O = 0A$	Full		0.05	10	μA	
Input Capacitance	C_I	$V_{CC} = 3.3V$, $V_I = GND$ to V_{CC}	+25°C		3.5		pF	

DYNAMIC CHARACTERISTICS

(For test circuit, see Figure 1. Full = -40°C to +125°C, all typical values are measured at T_A = +25°C and V_{CC} = 1.8V, 2.5V, 2.7V, 3.3V and 5.0V respectively, unless otherwise noted.)

PARAMETER	SYMBOL	CONDITIONS	TEMP	MIN ⁽¹⁾	TYP	MAX ⁽¹⁾	UNITS	
Propagation Delay ⁽²⁾	t _{PD}	A to Y, see Figure 2	V _{CC} = 1.65V to 1.95V	Full	0.5	6.4	15.0	ns
			V _{CC} = 2.3V to 2.7V	Full	0.5	3.6	7.5	
			V _{CC} = 2.7V	Full	0.5	3.3	7.5	
			V _{CC} = 3.0V to 3.6V	Full	0.5	3.1	6.5	
			V _{CC} = 4.5V to 5.5V	Full	0.5	2.7	5.0	
Enable Time ⁽³⁾	t _{EN}	$\overline{\text{OE}}$ to Y, see Figure 3	V _{CC} = 1.65V to 1.95V	Full	0.5	6.9	16.5	ns
			V _{CC} = 2.3V to 2.7V	Full	0.5	3.7	8.0	
			V _{CC} = 2.7V	Full	0.1	3.6	8.0	
			V _{CC} = 3.0V to 3.6V	Full	0.1	3.0	6.5	
			V _{CC} = 4.5V to 5.5V	Full	0.1	2.6	4.5	
Disable Time ⁽⁴⁾	t _{DIS}	$\overline{\text{OE}}$ to Y, see Figure 3	V _{CC} = 1.65V to 1.95V	Full	0.5	6.4	12.5	ns
			V _{CC} = 2.3V to 2.7V	Full	0.5	3.6	6.5	
			V _{CC} = 2.7V	Full	0.5	4.2	6.5	
			V _{CC} = 3.0V to 3.6V	Full	0.5	4.2	6.5	
			V _{CC} = 4.5V to 5.5V	Full	0.5	3.5	5.0	
Power Dissipation Capacitance ⁽⁵⁾	C _{PD}	V _I = GND to V _{CC}	Output enabled	+25°C		32.0	pF	
			Output disabled	+25°C		0.5		

NOTES:

- Specified by design and characterization; not production tested.
- t_{PD} is the same as t_{PLH} and t_{PHL}.
- t_{EN} is the same as t_{PZH} and t_{PZL}.
- t_{DIS} is the same as t_{PLZ} and t_{PHZ}.
- C_{PD} is used to determine the dynamic power dissipation (P_D in μW).

$$P_D = C_{PD} \times V_{CC}^2 \times f_i \times N + \Sigma(C_L \times V_{CC}^2 \times f_o)$$
 where:
 f_i = Input frequency in MHz.
 f_o = Output frequency in MHz.
 C_L = Output load capacitance in pF.
 V_{CC} = Supply voltage in Volts.
 N = Number of inputs switching.
 Σ(C_L × V_{CC}² × f_o) = Sum of outputs.

TEST CIRCUIT

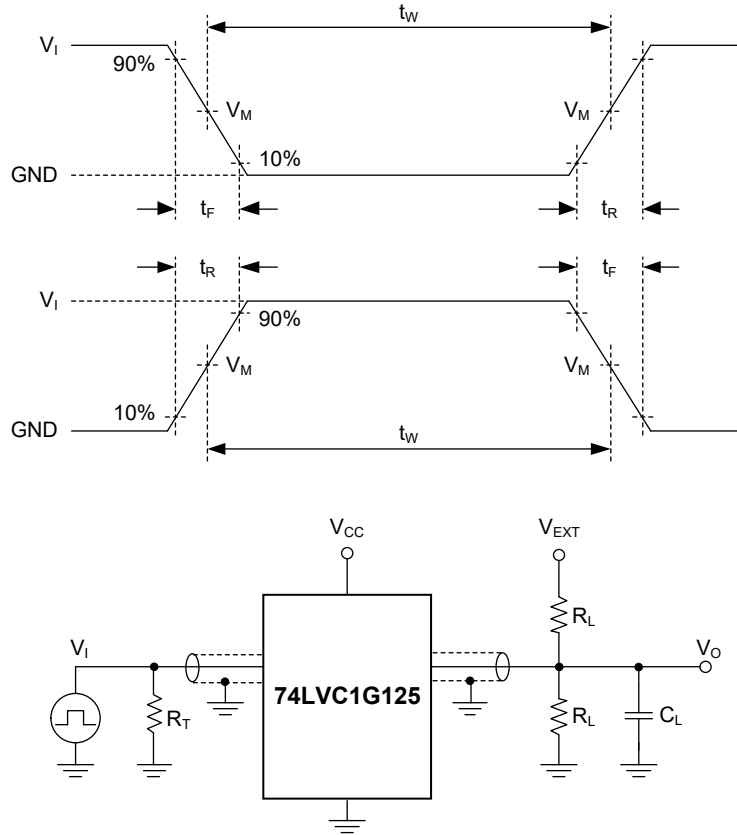

Test conditions are given in Table 1.

Definitions for test circuit:

R_L : Load resistance.

C_L : Load capacitance (includes jig and probe).

R_T : Termination resistance (equals to output impedance Z_O of the pulse generator).

V_{EXT} : External voltage used to measure switching time.

Figure 1. Test Circuit for Measuring Switching Times

Table 1. Test Conditions

SUPPLY VOLTAGE	INPUT		LOAD		V_{EXT}		
V_{CC}	V_I	t_r, t_f	C_L	R_L	t_{PLH}, t_{PHL}	t_{PLZ}, t_{PZL}	t_{PHZ}, t_{PZH}
1.65V to 1.95V	V_{CC}	$\leq 2.0ns$	30pF	1k Ω	Open	$2V_{CC}$	GND
2.3V to 2.7V	V_{CC}	$\leq 2.0ns$	30pF	500 Ω	Open	$2V_{CC}$	GND
2.7V	2.7V	$\leq 2.5ns$	50pF	500 Ω	Open	6V	GND
3.0V to 3.6V	2.7V	$\leq 2.5ns$	50pF	500 Ω	Open	6V	GND
4.5V to 5.5V	V_{CC}	$\leq 2.5ns$	50pF	500 Ω	Open	$2V_{CC}$	GND

WAVEFORMS

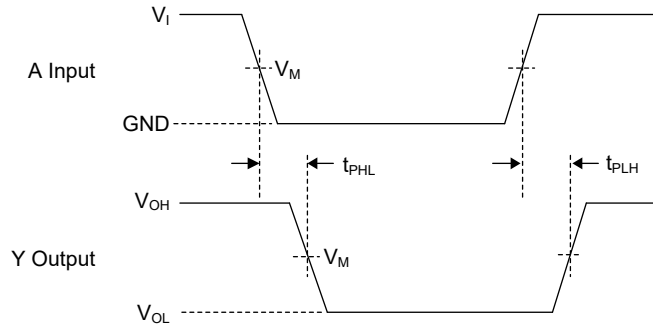

Test conditions are given in Table 1.
Measurement points are given in Table 2.
Logic levels: V_{OL} and V_{OH} are typical output voltage levels that occur with the output load.

Figure 2. Input A to Output Y Propagation Delays

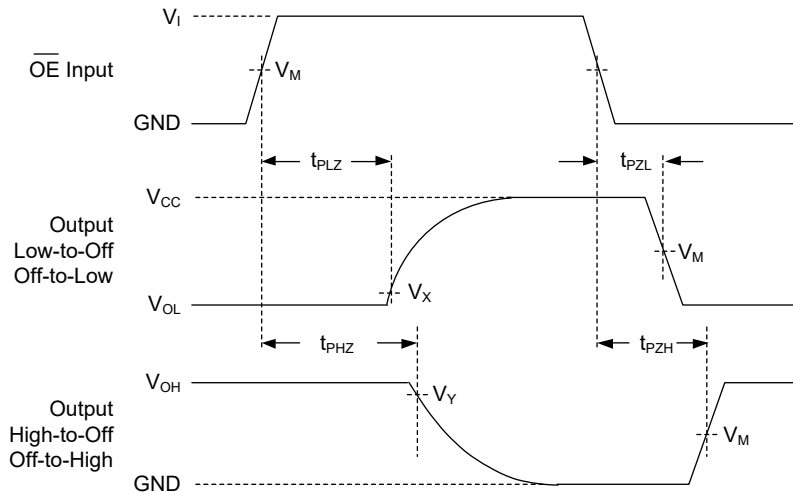

Test conditions are given in Table 1.
Measurement points are given in Table 2.
Logic levels: V_{OL} and V_{OH} are typical output voltage levels that occur with the output load.

Figure 3. 3-State Enable and Disable Times

Table 2. Measurement Points

SUPPLY VOLTAGE	INPUT	OUTPUT		
V_{CC}	$V_M^{(1)}$	V_M	V_X	V_Y
1.65V to 1.95V	$0.5V_{CC}$	$0.5V_{CC}$	$V_{OL} + 0.15V$	$V_{OH} - 0.15V$
2.3V to 2.7V	$0.5V_{CC}$	$0.5V_{CC}$	$V_{OL} + 0.15V$	$V_{OH} - 0.15V$
2.7V	1.5V	1.5V	$V_{OL} + 0.3V$	$V_{OH} - 0.3V$
3.0V to 3.6V	1.5V	1.5V	$V_{OL} + 0.3V$	$V_{OH} - 0.3V$
4.5V to 5.5V	$0.5V_{CC}$	$0.5V_{CC}$	$V_{OL} + 0.3V$	$V_{OH} - 0.3V$

NOTE:

1. The measurement points should be V_{IH} or V_{IL} when the input rising or falling time exceeds 2.5ns.

REVISION HISTORY

NOTE: Page numbers for previous revisions may differ from page numbers in the current version.

AUGUST 2022 – REV.A.2 to REV.A.3		Page
Updated Absolute Maximum Ratings section.....		2
JULY 2022 – REV.A.1 to REV.A.2		Page
Updated Electrical Characteristics section.....		4
Updated Dynamic Characteristics section.....		5
Added SOT-23-5 package		All
NOVEMBER 2021 – REV.A to REV.A.1		Page
Updated Dynamic Characteristics section.....		5
Added note of Table 2		7
Changes from Original (FEBRUARY 2021) to REV.A		Page
Changed from product preview to production data.....		All

PACKAGE OUTLINE DIMENSIONS

SC70-5

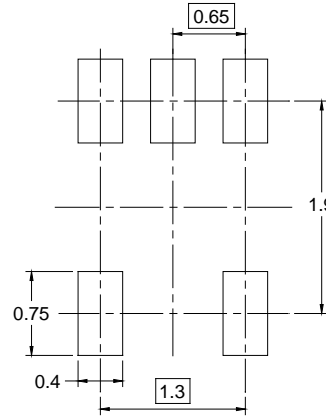
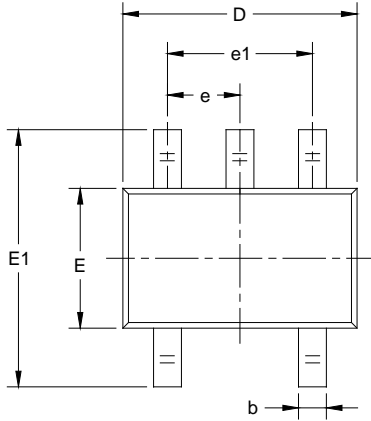

RECOMMENDED LAND PATTERN (Unit: mm)

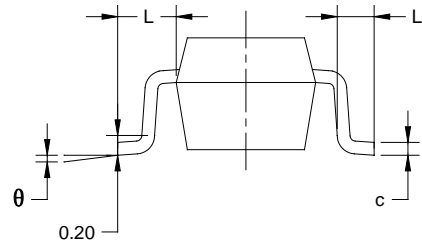
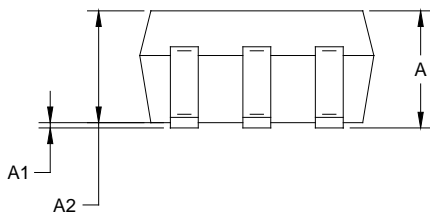

Symbol	Dimensions In Millimeters		Dimensions In Inches	
	MIN	MAX	MIN	MAX
A	0.800	1.100	0.031	0.043
A1	0.000	0.100	0.000	0.004
A2	0.800	1.000	0.031	0.039
b	0.150	0.350	0.006	0.014
c	0.080	0.220	0.003	0.009
D	2.000	2.200	0.079	0.087
E	1.150	1.350	0.045	0.053
E1	2.150	2.450	0.085	0.096
e	0.65 TYP		0.026 TYP	
e1	1.300 BSC		0.051 BSC	
L	0.525 REF		0.021 REF	
L1	0.260	0.460	0.010	0.018
θ	0°	8°	0°	8°

NOTES:

1. Body dimensions do not include mode flash or protrusion.
2. This drawing is subject to change without notice.

PACKAGE OUTLINE DIMENSIONS

SOT-23-5

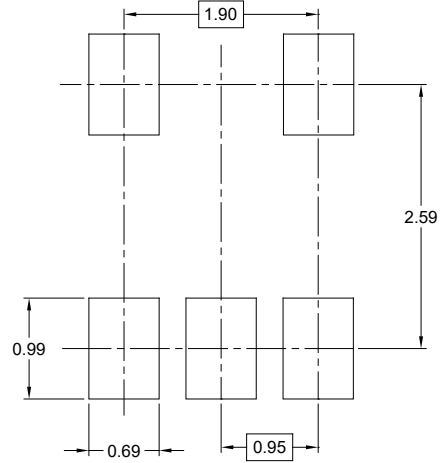
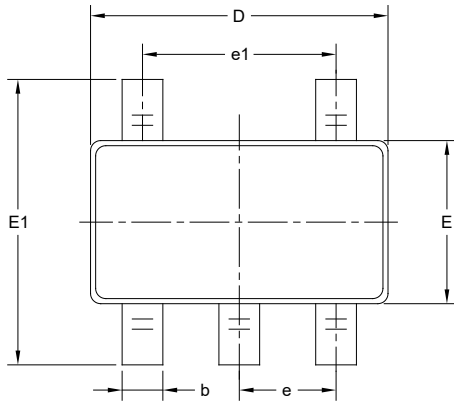

RECOMMENDED LAND PATTERN (Unit: mm)

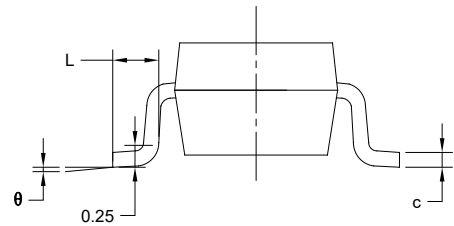
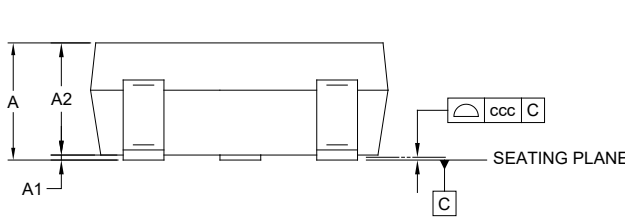

Symbol	Dimensions In Millimeters		
	MIN	MOD	MAX
A	-	-	1.450
A1	0.000	-	0.150
A2	0.900	-	1.300
b	0.300	-	0.500
c	0.080	-	0.220
D	2.750	-	3.050
E	1.450	-	1.750
E1	2.600	-	3.000
e	0.950 BSC		
e1	1.900 BSC		
L	0.300	-	0.600
θ	0°	-	8°
ccc	0.100		

NOTES:

1. This drawing is subject to change without notice.
2. The dimensions do not include mold flashes, protrusions or gate burrs.
3. Reference JEDEC MO-178.

PACKAGE INFORMATION

TAPE AND REEL INFORMATION

REEL DIMENSIONS



TAPE DIMENSIONS



NOTE: The picture is only for reference. Please make the object as the standard.

KEY PARAMETER LIST OF TAPE AND REEL

Package Type	Reel Diameter	Reel Width W1 (mm)	A0 (mm)	B0 (mm)	K0 (mm)	P0 (mm)	P1 (mm)	P2 (mm)	W (mm)	Pin1 Quadrant
SC70-5	7"	9.5	2.40	2.50	1.20	4.0	4.0	2.0	8.0	Q3
SOT-23-5	7"	9.5	3.20	3.20	1.40	4.0	4.0	2.0	8.0	Q3

DD0001

PACKAGE INFORMATION

CARTON BOX DIMENSIONS



NOTE: The picture is only for reference. Please make the object as the standard.

KEY PARAMETER LIST OF CARTON BOX

Reel Type	Length (mm)	Width (mm)	Height (mm)	Pizza/Carton
7" (Option)	368	227	224	8
7"	442	410	224	18

DD0002

单击下面可查看定价，库存，交付和生命周期等信息

[>>SGMICRO\(圣邦微电子\)](#)