

GENERAL DESCRIPTION

The SGM7SZ04 is a single inverter with the advanced CMOS technology. The supply voltage pin of this device accepts any voltage from 1.65V to 5.5V. The inputs can tolerate a maximum of 6V, regardless of the supply voltage range. When V_{CC} is at 0V, the inputs and output are in the high-impedance state.

This device can achieve ultra-high speed operation with high output drive, while the low static power dissipation over the wide supply voltage operating range is maintained.

The SGM7SZ04 is available in Green UTDFN-1.45×1-6L, SC70-5 and SOT-23-5 packages. It operates over an ambient temperature range of -40°C to +125°C.

LOGIC SYMBOL

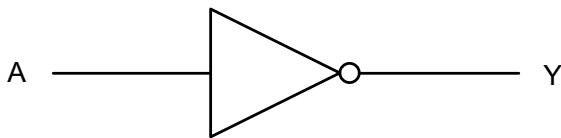

FEATURES

- **Wide Supply Voltage Range: 1.65V to 5.5V**
- **Ultra-High Speed: t_{PD} of 4.2ns (TYP) into 50pF at $V_{CC} = 3.3V$**
- **Support LCX Performance at $V_{CC} = 3.3V$**
- **High Output Drive: $\pm 24mA$ at $V_{CC} = 3V$**
- **Inputs Over-Voltage Tolerance Makes 5V to 3V Translation Available**
- **Power Down High-Impedance Inputs/Output**
- **Available in Green UTDFN-1.45×1-6L, SC70-5 and SOT-23-5 Packages**

FUNCTION TABLE

INPUT	OUTPUT
A	Y
L	H
H	L

$$Y = \bar{A}$$

H = High Voltage Level

L = Low Voltage Level

PIN CONFIGURATIONS

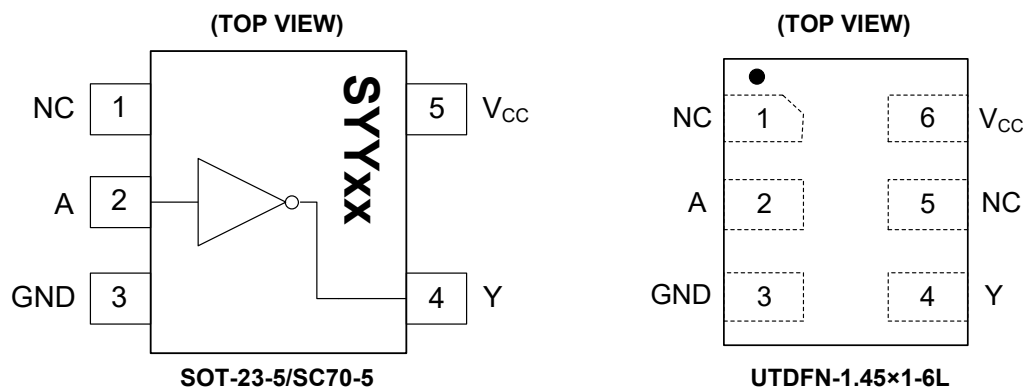

PIN DESCRIPTION

PIN		NAME	FUNCTION
SOT-23-5/SC70-5	UTDFN-1.45x1-6L		
1	1, 5	NC	No Connection.
2	2	A	Input. Unused input must be held high or low. It may not float.
3	3	GND	Ground.
4	4	Y	Output.
5	6	V _{CC}	Power Supply.

ELECTRICAL CHARACTERISTICS

(Full = -40°C to +125°C, typical values are at T_A = +25°C, unless otherwise noted.)

PARAMETER	SYMBOL	CONDITIONS		V _{CC} (V)	MIN	TYP	MAX	UNITS
General								
Power Supply Range	V _{CC}				1.65		5.50	V
Supply Voltage Data Retention					1.50		5.50	
Input Voltage	V _{IN}				0.00		5.50	V
Output Voltage	V _{OUT}				0.00		V _{CC}	V
Input Rise and Fall Times	t _r , t _f			1.8, 2.5 ± 0.2	0		20	ns/V
				3.3 ± 0.3	0		10	
				5.0 ± 0.5	0		5	
DC Performance								
High-Level Input Voltage	V _{IH}			1.65 to 5.5	0.75 × V _{CC}			V
Low-Level Input Voltage	V _{IL}			1.65 to 5.5			0.20 × V _{CC}	V
High-Level Output Voltage	V _{OH}	V _{IN} = V _{IL}	I _{OH} = -100μA	1.65	1.62	1.65		V
				1.80	1.77	1.80		
				2.30	2.27	2.30		
				3.00	2.97	3.00		
				4.50	4.47	4.50		
			I _{OH} = -4mA	1.65	1.46	1.55		
			I _{OH} = -8mA	2.30	2.01	2.18		
			I _{OH} = -16mA	3.00	2.49	2.81		
			I _{OH} = -24mA	3.00	2.30	2.70		
Low-Level Output Voltage	V _{OL}	V _{IN} = V _{IH}	I _{OL} = 100μA	1.65		0.00	0.02	V
				1.80		0.00	0.02	
				2.30		0.00	0.02	
				3.00		0.00	0.02	
				4.50		0.00	0.02	
			I _{OL} = 4mA	1.65		0.06	0.12	
			I _{OL} = 8mA	2.30		0.09	0.18	
			I _{OL} = 16mA	3.00		0.16	0.33	
			I _{OL} = 24mA	3.00		0.24	0.51	
			I _{OL} = 32mA	4.50		0.29	0.58	
Input Leakage Current	I _{IN}	V _{IN} = 5.5V, GND		0 to 5.5		±0.10	±5	μA
Power-Off Leakage Current	I _{OFF}	V _{IN} or V _{OUT} = 5.5V		0		0.10	5	μA
Quiescent Supply Current	I _{CC}	V _{IN} = 5.5V, GND		1.65 to 5.5		0.10	10	μA

ELECTRICAL CHARACTERISTICS (continued)(Full = -40°C to +125°C, typical values are at T_A = +25°C, unless otherwise noted.)

PARAMETER	SYMBOL	CONDITIONS	MIN	TYP	MAX	UNITS
AC Performance						
Propagation Delay	t _{PHL} , t _{PLH}	V _{CC} = 1.65V	C _L = 15pF, R _L = 1MΩ, Figure 1, Figure 2		9.6	ns
		V _{CC} = 1.80V			7.9	
		V _{CC} = 2.50V ± 0.20V			4.9	
		V _{CC} = 3.30V ± 0.30V			3.7	
		V _{CC} = 5.00V ± 0.50V			2.8	
		V _{CC} = 3.30V ± 0.30V		C _L = 50pF, R _L = 500Ω, Figure 1, Figure 2		
		V _{CC} = 5.00V ± 0.50V			3.2	
Input Capacitance	C _{IN}	V _{CC} = 0V		4.0		pF
Power Dissipation Capacitance ⁽²⁾	C _{PD}	V _{CC} = 3.30V	Figure 3		16.0	pF
		V _{CC} = 5.00V			19.0	

NOTES:

- Unused input must be held high or low. It may not float.
- C_{PD} is defined as the value of the internal equivalent capacitance which is derived from dynamic operating current consumption (I_{CCD}) at no output loading and operating at 50% duty cycle (see Figure 3). C_{PD} is related to dynamic operating current I_{CCD} by the expression: I_{CCD} = (C_{PD}) (V_{CC}) (f_{IN}) + (I_{CC,Static}).

TEST CIRCUITS

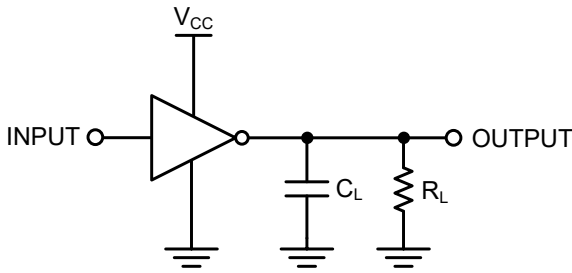

C_L includes load and stray capacitance;
Input PRR = 1.0MHz; t_w = 500ns.

Figure 1. AC Test Circuit

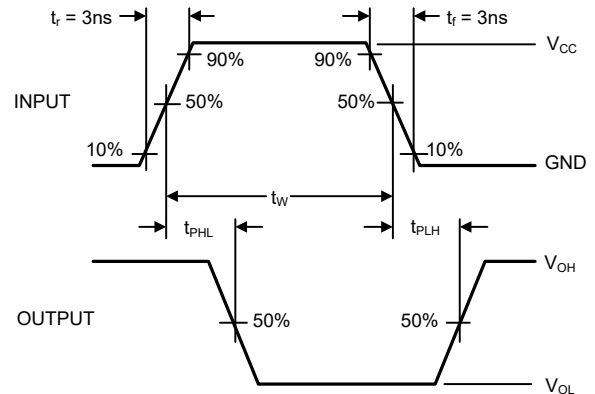
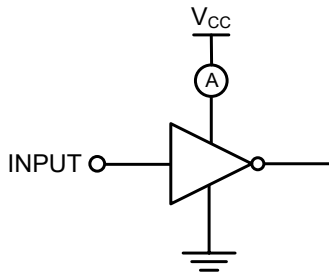

Figure 2. AC Waveforms



Input = AC Waveform; $t_r = t_f = 1.8ns$;
PRR = 10MHz; Duty Cycle = 50%.

Figure 3. I_{CCD} Test Circuit

REVISION HISTORY

NOTE: Page numbers for previous revisions may differ from page numbers in the current version.

SEPTEMBER 2021 – REV.A.2 to REV.A.3	Page
Updated Package Outline Dimensions section	8, 9
FEBRUARY 2021 – REV.A.1 to REV.A.2	Page
Changed operating temperature range	All
APRIL 2014 – REV.A to REV.A.1	Page
Added UTDFN-1.45x1-6L package.....	All
Changes from Original (OCTOBER 2013) to REV.A	Page
Changed from product preview to production data.....	All

PACKAGE OUTLINE DIMENSIONS

SOT-23-5

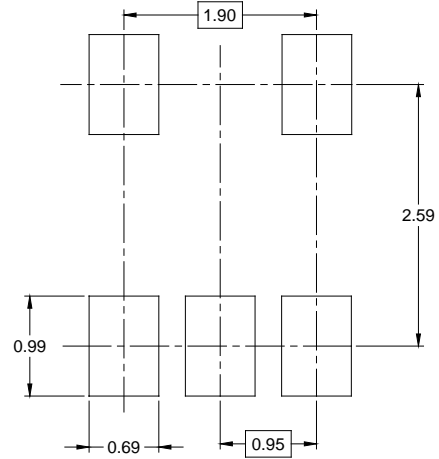
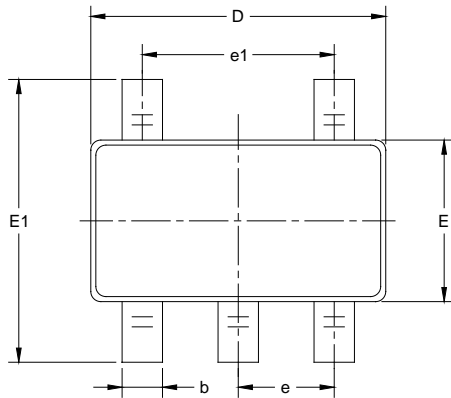

RECOMMENDED LAND PATTERN (Unit: mm)

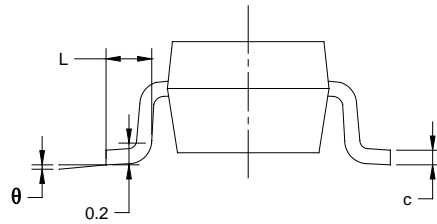
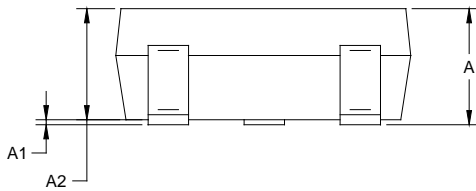

Symbol	Dimensions In Millimeters		Dimensions In Inches	
	MIN	MAX	MIN	MAX
A	1.050	1.250	0.041	0.049
A1	0.000	0.100	0.000	0.004
A2	1.050	1.150	0.041	0.045
b	0.300	0.500	0.012	0.020
c	0.100	0.200	0.004	0.008
D	2.820	3.020	0.111	0.119
E	1.500	1.700	0.059	0.067
E1	2.650	2.950	0.104	0.116
e	0.950 BSC		0.037 BSC	
e1	1.900 BSC		0.075 BSC	
L	0.300	0.600	0.012	0.024
θ	0°	8°	0°	8°

NOTES:

1. Body dimensions do not include mode flash or protrusion.
2. This drawing is subject to change without notice.

PACKAGE OUTLINE DIMENSIONS

SC70-5

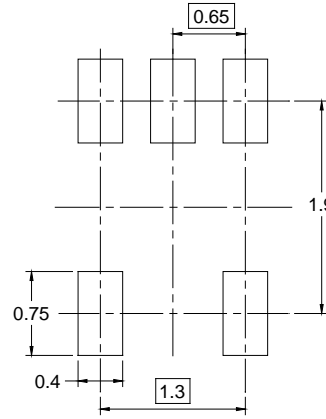
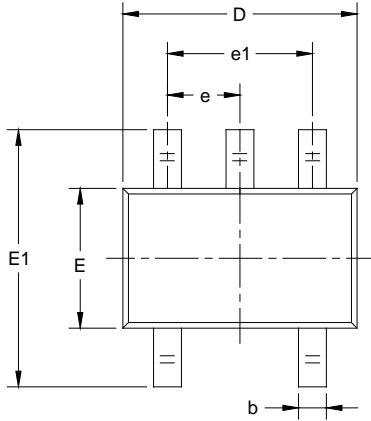

RECOMMENDED LAND PATTERN (Unit: mm)

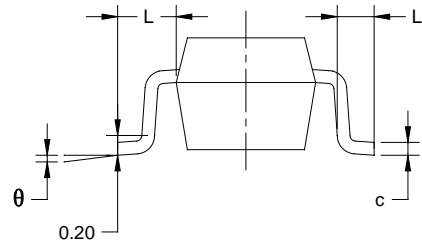
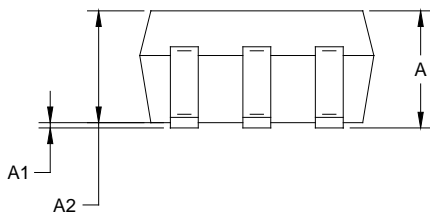

Symbol	Dimensions In Millimeters		Dimensions In Inches	
	MIN	MAX	MIN	MAX
A	0.800	1.100	0.031	0.043
A1	0.000	0.100	0.000	0.004
A2	0.800	1.000	0.031	0.039
b	0.150	0.350	0.006	0.014
c	0.080	0.220	0.003	0.009
D	2.000	2.200	0.079	0.087
E	1.150	1.350	0.045	0.053
E1	2.150	2.450	0.085	0.096
e	0.65 TYP		0.026 TYP	
e1	1.300 BSC		0.051 BSC	
L	0.525 REF		0.021 REF	
L1	0.260	0.460	0.010	0.018
θ	0°	8°	0°	8°

NOTES:

1. Body dimensions do not include mode flash or protrusion.
2. This drawing is subject to change without notice.

PACKAGE OUTLINE DIMENSIONS

UTDFN-1.45x1-6L

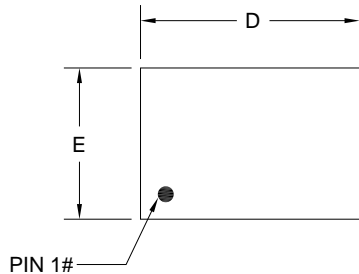

TOP VIEW

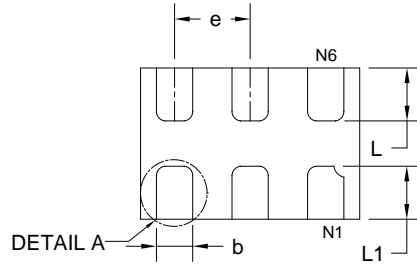

BOTTOM VIEW

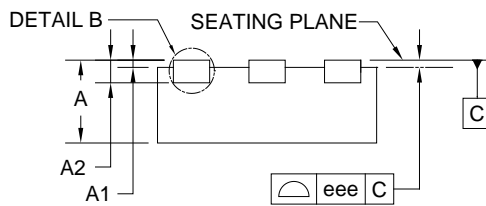

SIDE VIEW

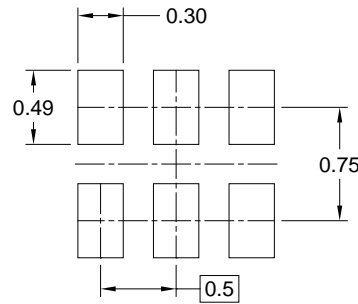

RECOMMENDED LAND PATTERN (Unit: mm)

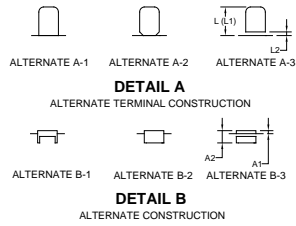

Symbol	Dimensions In Millimeters		Dimensions In Inches	
	MIN	MAX	MIN	MAX
A	0.450	0.600	0.018	0.024
A1	0.000	0.050	0.000	0.002
A2	0.150 REF		0.006 REF	
D	1.374	1.526	0.054	0.060
E	0.924	1.076	0.036	0.042
b	0.150	0.300	0.006	0.012
e	0.500 TYP		0.020 TYP	
eee	0.050		0.002	
L	0.250	0.450	0.010	0.018
L1	0.250	0.500	0.010	0.020
L2	0.000	0.100	0.000	0.004

NOTE: This drawing is subject to change without notice.

PACKAGE INFORMATION

TAPE AND REEL INFORMATION

REEL DIMENSIONS



TAPE DIMENSIONS



NOTE: The picture is only for reference. Please make the object as the standard.

KEY PARAMETER LIST OF TAPE AND REEL

Package Type	Reel Diameter	Reel Width W1 (mm)	A0 (mm)	B0 (mm)	K0 (mm)	P0 (mm)	P1 (mm)	P2 (mm)	W (mm)	Pin1 Quadrant
SOT-23-5	7"	9.5	3.20	3.20	1.40	4.0	4.0	2.0	8.0	Q3
SC70-5	7"	9.5	2.25	2.55	1.20	4.0	4.0	2.0	8.0	Q3
UTDFN-1.45×1-6L	7"	9.5	1.15	1.60	0.75	4.0	4.0	2.0	8.0	Q1

DD0001

PACKAGE INFORMATION

CARTON BOX DIMENSIONS



NOTE: The picture is only for reference. Please make the object as the standard.

KEY PARAMETER LIST OF CARTON BOX

Reel Type	Length (mm)	Width (mm)	Height (mm)	Pizza/Carton
7" (Option)	368	227	224	8
7"	442	410	224	18

DD0002

单击下面可查看定价，库存，交付和生命周期等信息

[>>SGMICRO\(圣邦微电子\)](#)