



SGM8046

670nA, Non-Unity Gain, Dual Rail-to-Rail I/O Operational Amplifier

GENERAL DESCRIPTION

The SGM8046 is a dual, high precision operational amplifier which can operate from 1.4V to 5.5V single supply, while consuming only 670nA/amplifier quiescent current. It provides rail-to-rail input and output operation. Therefore, the SGM8046 is suitable for use in portable instrumentation and battery-powered systems.

The SGM8046 is stable for gains ≥ 10 , and features a 100kHz gain-bandwidth product. It is designed to provide optimal performance in low frequency systems, when monitoring battery current and conditioning sensor signal.

The SGM8046 is available in Green SOIC-8 and MSOP-8 packages. It operates over an ambient temperature range of -40°C to $+85^{\circ}\text{C}$.

FEATURES

- **Low Quiescent Current: 670nA/Amplifier (TYP)**
- **Rail-to-Rail Input and Output**
- **Gain-Bandwidth Product: 100kHz (TYP)**
- **Stable for Gains ≥ 10**
- **Wide Supply Voltage Range: 1.4V to 5.5V**
- **-40°C to $+85^{\circ}\text{C}$ Operating Temperature Range**
- **Available in Green SOIC-8 and MSOP-8 Packages**

APPLICATIONS

Temperature Measurements
Toll Booth Tags
Battery-Powered Systems
Wearable Products

PACKAGE/ORDERING INFORMATION

MODEL	PACKAGE DESCRIPTION	SPECIFIED TEMPERATURE RANGE	ORDERING NUMBER	PACKAGE MARKING	PACKING OPTION
SGM8046	SOIC-8	-40°C to +85°C	SGM8046YS8G/TR	SGM8046YS8 XXXXX	Tape and Reel, 2500
	MSOP-8	-40°C to +85°C	SGM8046YMS8G/TR	SGM8046 YMS8 XXXXX	Tape and Reel, 3000

MARKING INFORMATION

NOTE: XXXXX = Date Code and Vendor Code.

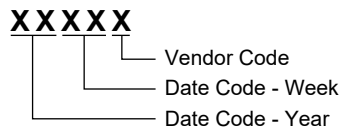

Green (RoHS & HSF): SG Micro Corp defines "Green" to mean Pb-Free (RoHS compatible) and free of halogen substances. If you have additional comments or questions, please contact your SGMICRO representative directly.

ABSOLUTE MAXIMUM RATINGS

- Supply Voltage.....6V
- Analog Inputs (+IN, -IN)..... (-Vs) - 0.1V to (+Vs) + 0.1V
- Differential Input Voltage..... |(-Vs) - (+Vs)|
- Junction Temperature.....+150°C
- Storage Temperature Range.....-65°C to +150°C
- Lead Temperature (Soldering, 10s).....+260°C
- ESD Susceptibility
- HBM.....4000V
- MM.....400V

RECOMMENDED OPERATING CONDITIONS

- Operating Temperature Range.....-40°C to +85°C

OVERSTRESS CAUTION

Stresses beyond those listed in Absolute Maximum Ratings may cause permanent damage to the device. Exposure to absolute maximum rating conditions for extended periods may affect reliability. Functional operation of the device at any conditions beyond those indicated in the Recommended Operating Conditions section is not implied.

ESD SENSITIVITY CAUTION

This integrated circuit can be damaged if ESD protections are not considered carefully. SGMICRO recommends that all integrated circuits be handled with appropriate precautions. Failure to observe proper handling and installation procedures can cause damage. ESD damage can range from subtle

performance degradation to complete device failure. Precision integrated circuits may be more susceptible to damage because even small parametric changes could cause the device not to meet the published specifications.

DISCLAIMER

SG Micro Corp reserves the right to make any change in circuit design, or specifications without prior notice.

PIN CONFIGURATIONS

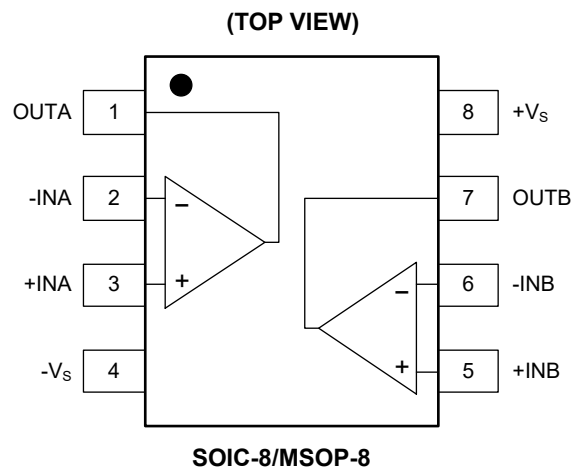

ELECTRICAL CHARACTERISTICS

(At $T_A = +25^\circ\text{C}$, $+V_S = 1.4\text{V}$ to 5.0V , $-V_S = \text{GND}$, $A_V = 10$, $V_{CM} = +V_S/2$, $V_{OUT} \approx +V_S/2$ and $R_L = 1\text{M}\Omega$ to $+V_S/2$, unless otherwise noted.)

PARAMETER	SYMBOL	CONDITIONS	MIN	TYP	MAX	UNITS
DC Electrical Characteristics						
Input Offset Voltage	V_{OS}	$V_{CM} = +V_S/2$		0.4	2.5	mV
Input Offset Voltage Drift	$\Delta V_{OS}/\Delta T$	$V_{CM} = +V_S/2$, $-40^\circ\text{C} \leq T_A \leq +85^\circ\text{C}$		2.5		$\mu\text{V}/^\circ\text{C}$
Power Supply Rejection Ratio	PSRR	$+V_S = 1.4\text{V}$ to 5.5V	77	84		dB
Input Common Mode Voltage Range	V_{CMR}		$(-V_S) - 0.1$		$(+V_S) + 0.1$	V
Common Mode Rejection Ratio	CMRR	$+V_S = 5.0\text{V}$, $V_{CM} = -0.1\text{V}$ to 5.1V	68	82		dB
		$+V_S = 5.0\text{V}$, $V_{CM} = 2.5\text{V}$ to 5.1V	71	76		
		$+V_S = 5.0\text{V}$, $V_{CM} = -0.1\text{V}$ to 2.5V	66	81		
Large-Signal Voltage Gain	A_{VO}	$+V_S = 1.4\text{V}$, $R_L = 50\text{k}\Omega$, $V_{OUT} = (+V_S) - 0.1\text{V}$	69	77		dB
		$+V_S = 2.5\text{V}$, $R_L = 50\text{k}\Omega$, $V_{OUT} = (+V_S) - 0.1\text{V}$		86		
		$+V_S = 5.0\text{V}$, $R_L = 50\text{k}\Omega$, $V_{OUT} = (+V_S) - 0.1\text{V}$	84	92		
Input Bias Current	I_B			1		pA
Input Offset Current	I_{OS}			1		pA
Maximum Output Voltage Swing	V_{OH}	$+V_S = 1.4\text{V}$, $R_L = 50\text{k}\Omega$	1.390	1.395		V
		$+V_S = 2.5\text{V}$, $R_L = 50\text{k}\Omega$		2.497		
		$+V_S = 5.0\text{V}$, $R_L = 50\text{k}\Omega$	4.990	4.997		
	V_{OL}	$+V_S = 1.4\text{V}$, $R_L = 50\text{k}\Omega$		4.8	10	mV
		$+V_S = 2.5\text{V}$, $R_L = 50\text{k}\Omega$		3.0		
		$+V_S = 5.0\text{V}$, $R_L = 50\text{k}\Omega$		3.4	10	
Output Short-Circuit Current	I_{SC}	$+V_S = 2.5\text{V}$		4.8		mA
		$+V_S = 5.0\text{V}$	22	24		
Supply Voltage	V_{CC}		1.4		5.5	V
Quiescent Current/Amplifier	I_Q	$+V_S = 1.4\text{V}$		560		nA
		$+V_S = 2.5\text{V}$		620		
		$+V_S = 5.0\text{V}$		670	1500	

ELECTRICAL CHARACTERISTICS (continued)

(At $T_A = +25^\circ\text{C}$, $+V_S = 1.4\text{V}$ to 5.0V , $-V_S = \text{GND}$, $A_v = 10$, $V_{CM} = +V_S/2$, $V_{OUT} \approx +V_S/2$ and $R_L = 1\text{M}\Omega$ to $+V_S/2$, $C_L = 60\text{pF}$, unless otherwise noted.)

PARAMETER	SYMBOL	CONDITIONS	MIN	TYP	MAX	UNITS
AC Electrical Characteristics						
Gain-Bandwidth Product	GBP			100		kHz
Slew Rate	SR	$+V_S = 1.4\text{V}$, $V_{OUT} = 1\text{V}$ Step		10.5		V/ms
		$+V_S = 2.5\text{V}$, $V_{OUT} = 1\text{V}$ Step		12.5		
		$+V_S = 5.0\text{V}$, $V_{OUT} = 2\text{V}$ Step		14.5		
Phase Margin	PM	$+V_S = 1.4\text{V}$ to 5.5V		60		$^\circ$
Input Voltage Noise	e_n p-p	$+V_S = 1.4\text{V}$, $f = 0.1\text{Hz}$ to 10Hz		3.2		μV_{P-P}
		$+V_S = 2.5\text{V}$, $f = 0.1\text{Hz}$ to 10Hz		3.0		
		$+V_S = 5.0\text{V}$, $f = 0.1\text{Hz}$ to 10Hz		3.0		
Input Voltage Noise Density	e_n	$+V_S = 1.4\text{V}$, $f = 1\text{kHz}$		190		$\text{nV}/\sqrt{\text{Hz}}$
		$+V_S = 2.5\text{V}$, $f = 1\text{kHz}$		180		
		$+V_S = 5.0\text{V}$, $f = 1\text{kHz}$		190		

TYPICAL PERFORMANCE CHARACTERISTICS

At $T_A = +25^\circ\text{C}$, $+V_S = 1.4\text{V}$ to 5.0V , $-V_S = \text{GND}$, $A_V = 10$, $V_{CM} = +V_S/2$, $V_{OUT} \approx +V_S/2$ and $R_L = 1\text{M}\Omega$ to $+V_S/2$, $C_L = 60\text{pF}$, unless otherwise noted.

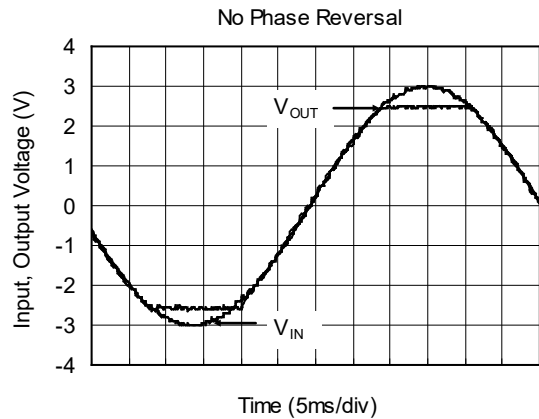
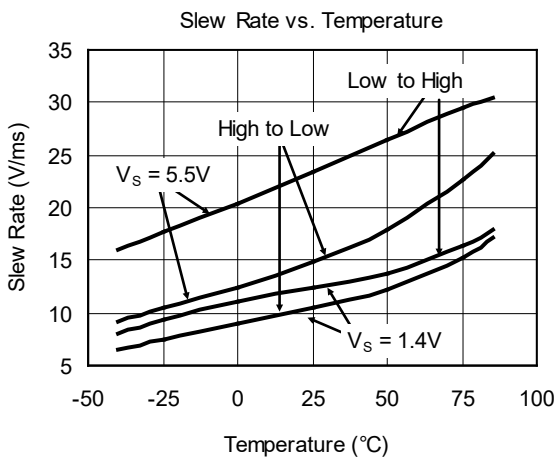
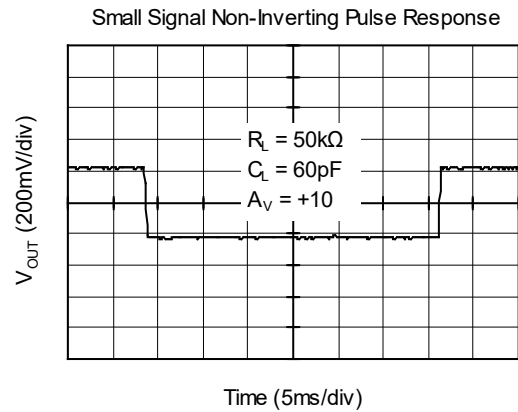
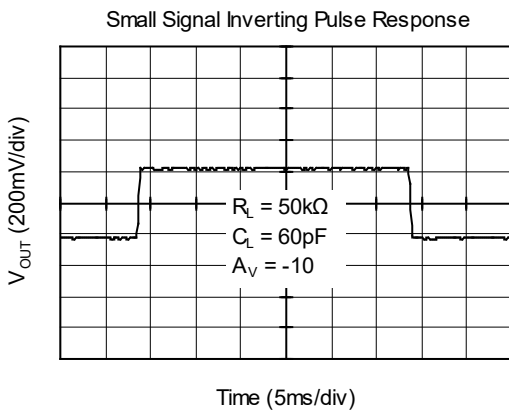
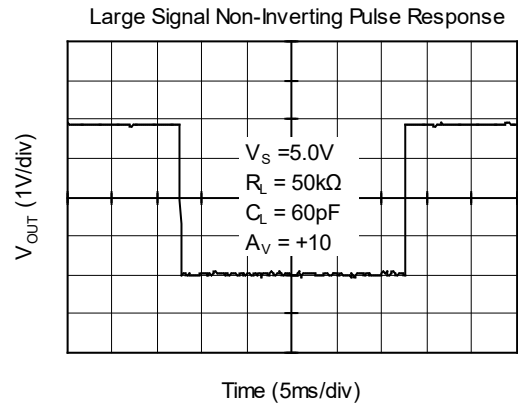
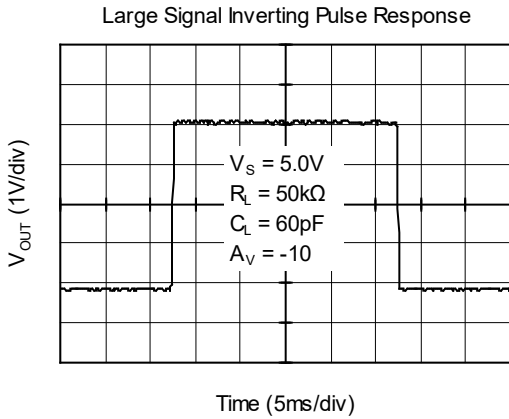

TYPICAL PERFORMANCE CHARACTERISTICS (continued)

At $T_A = +25^\circ\text{C}$, $+V_S = 1.4\text{V to } 5.0\text{V}$, $-V_S = \text{GND}$, $A_V = 10$, $V_{CM} = +V_S/2$, $V_{OUT} \approx +V_S/2$ and $R_L = 1\text{M}\Omega$ to $+V_S/2$, $C_L = 60\text{pF}$, unless otherwise noted.

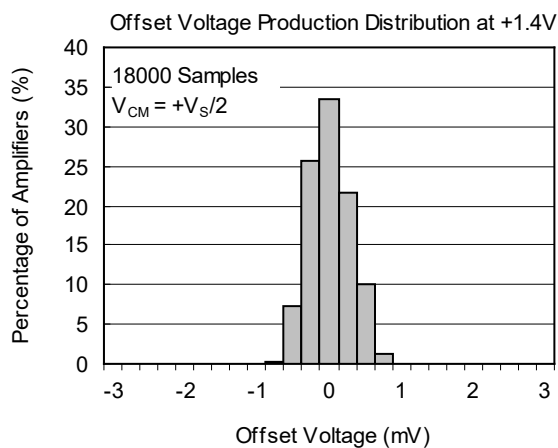
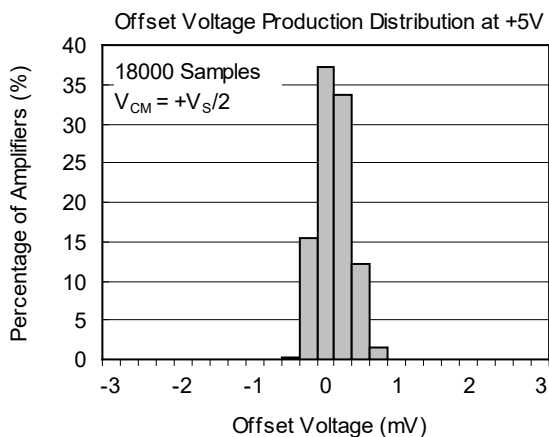

REVISION HISTORY

NOTE: Page numbers for previous revisions may differ from page numbers in the current version.

JANUARY 2013 – REV.A.1 to REV.A.2	Page
Added Tape and Reel Information section	9~10

MAY 2011 – REV.A to REV.A.1	Page
Updated Package Description	All

Changes from Original (APRIL 2010) to REV.A	Page
Changed from product preview to production data.....	All

PACKAGE OUTLINE DIMENSIONS

SOIC-8

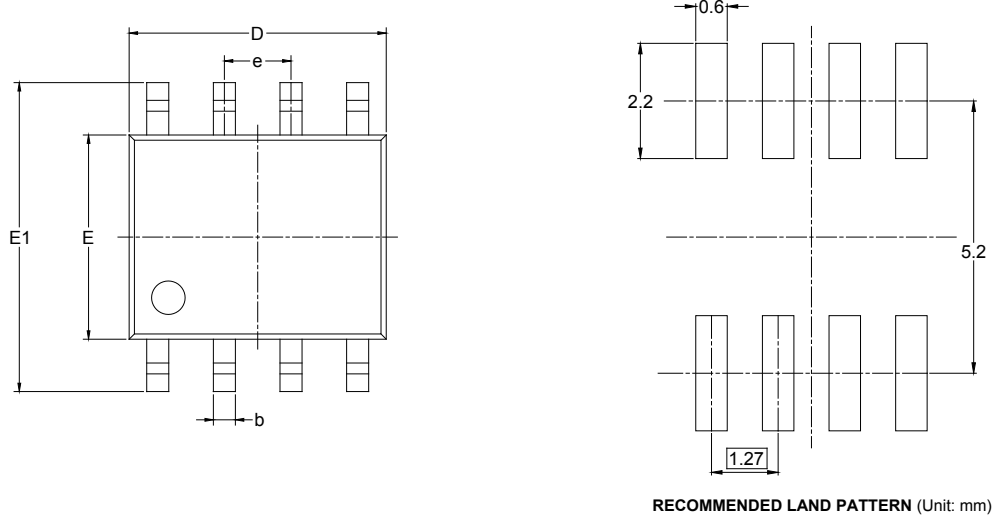

Symbol	Dimensions In Millimeters		Dimensions In Inches	
	MIN	MAX	MIN	MAX
A	1.350	1.750	0.053	0.069
A1	0.100	0.250	0.004	0.010
A2	1.350	1.550	0.053	0.061
b	0.330	0.510	0.013	0.020
c	0.170	0.250	0.006	0.010
D	4.700	5.100	0.185	0.200
E	3.800	4.000	0.150	0.157
E1	5.800	6.200	0.228	0.244
e	1.27 BSC		0.050 BSC	
L	0.400	1.270	0.016	0.050
θ	0°	8°	0°	8°

PACKAGE OUTLINE DIMENSIONS

MSOP-8

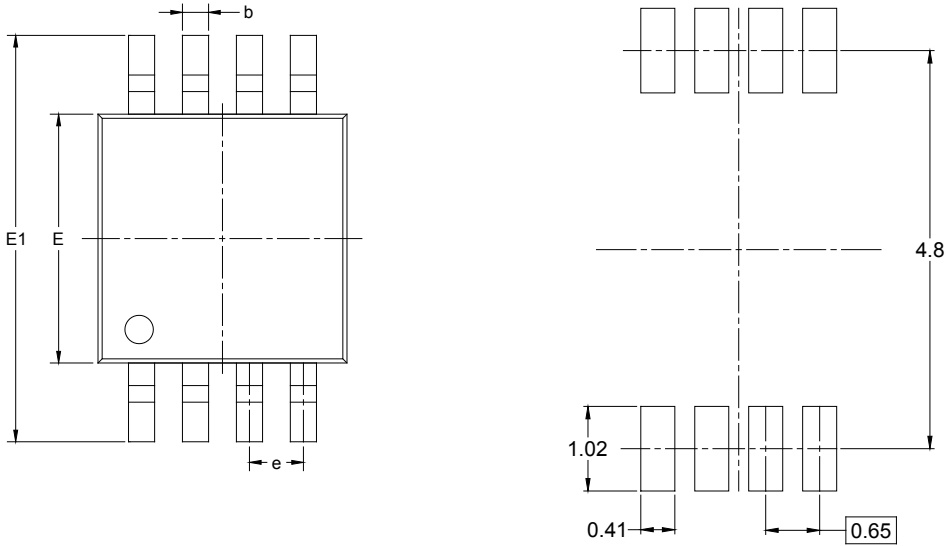

RECOMMENDED LAND PATTERN (Unit: mm)

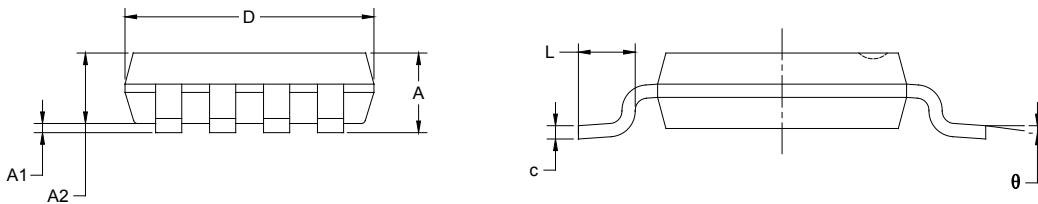

Symbol	Dimensions In Millimeters		Dimensions In Inches	
	MIN	MAX	MIN	MAX
A	0.820	1.100	0.032	0.043
A1	0.020	0.150	0.001	0.006
A2	0.750	0.950	0.030	0.037
b	0.250	0.380	0.010	0.015
c	0.090	0.230	0.004	0.009
D	2.900	3.100	0.114	0.122
E	2.900	3.100	0.114	0.122
E1	4.750	5.050	0.187	0.199
e	0.650 BSC		0.026 BSC	
L	0.400	0.800	0.016	0.031
θ	0°	6°	0°	6°

PACKAGE INFORMATION

TAPE AND REEL INFORMATION

REEL DIMENSIONS

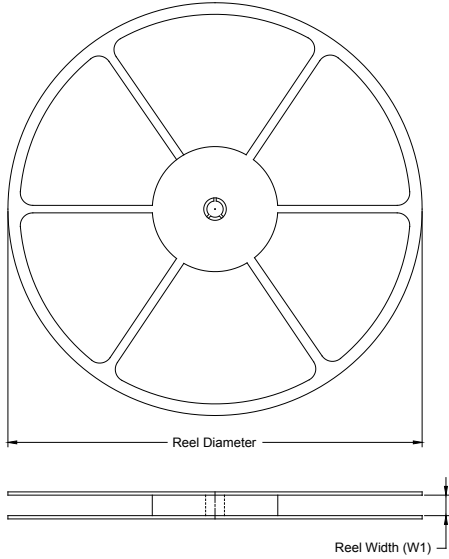

TAPE DIMENSIONS

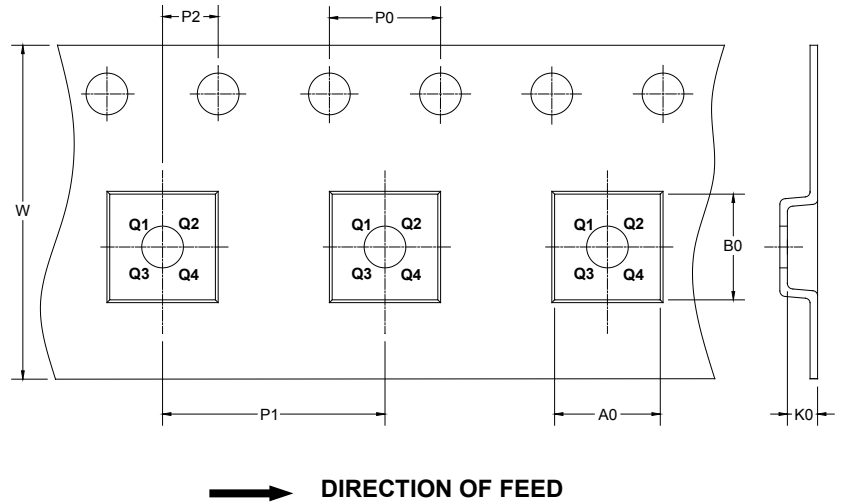

NOTE: The picture is only for reference. Please make the object as the standard.

KEY PARAMETER LIST OF TAPE AND REEL

Package Type	Reel Diameter	Reel Width W1 (mm)	A0 (mm)	B0 (mm)	K0 (mm)	P0 (mm)	P1 (mm)	P2 (mm)	W (mm)	Pin1 Quadrant
SOIC-8	13"	12.4	6.40	5.40	2.10	4.0	8.0	2.0	12.0	Q1
MSOP-8	13"	12.4	5.20	3.30	1.50	4.0	8.0	2.0	12.0	Q1

DD0001

PACKAGE INFORMATION

CARTON BOX DIMENSIONS



NOTE: The picture is only for reference. Please make the object as the standard.

KEY PARAMETER LIST OF CARTON BOX

Reel Type	Length (mm)	Width (mm)	Height (mm)	Pizza/Carton
13"	386	280	370	5

DD0002

单击下面可查看定价，库存，交付和生命周期等信息

[>>SGMICRO\(圣邦微电子\)](#)