



SGM8240-1/SGM8240-2/SGM8240-4

High Voltage, Low Power, Rail-to-Rail I/O Operational Amplifiers

GENERAL DESCRIPTION

The SGM8240-1 (single), SGM8240-2 (dual) and SGM8240-4 (quad) are micro-power and high voltage operational amplifiers suitable for battery-powered systems. These devices can operate from 2.7V to 24V single supply, while consuming only 2.8 μ A/Amplifier quiescent current. They also provide rail-to-rail input and output operation.

The SGM8240-1/2/4 provide low power, low bias current and low noise. These devices fit in small packages. The combination of above features makes them suitable for various applications.

The SGM8240-1 is available in Green SOT-23-5 and SC70-5 packages. The SGM8240-2 is available in Green SOIC-8, MSOP-8 and TDFN-2 \times 3-8L packages. The SGM8240-4 is available in a Green SOIC-14 package. They are specified from -40 $^{\circ}$ C to +125 $^{\circ}$ C temperature range.

FEATURES

- **Wide Supply Voltage Range: 2.7V to 24V**
- **Rail-to-Rail Input and Output**
- **Low Quiescent Current: 2.8 μ A/Amplifier (TYP)**
- **Low Offset Voltage: 0.4mV (TYP)**
- **Low 0.1Hz to 10Hz Noise: 3 μ V_{P-P}**
- **Input Voltage Noise Density: 100nV/ $\sqrt{\text{Hz}}$ at 1kHz**
- **CMRR: 110dB**
- **PSRR: 116dB**
- **Open-Loop Voltage Gain: 120dB**
- **Slew Rate: 0.05V/ μ s**
- **-40 $^{\circ}$ C to +125 $^{\circ}$ C Operating Temperature Range**
- **Small Packaging:**
 - SGM8240-1 Available in Green SOT-23-5 and SC70-5 Packages**
 - SGM8240-2 Available in Green SOIC-8, MSOP-8 and TDFN-2 \times 3-8L Packages**
 - SGM8240-4 Available in a Green SOIC-14 Package**

APPLICATIONS

Battery-Powered Systems
Handheld Test Equipment
Medical Instruments
Portable Devices

PACKAGE/ORDERING INFORMATION

MODEL	PACKAGE DESCRIPTION	SPECIFIED TEMPERATURE RANGE	ORDERING NUMBER	PACKAGE MARKING	PACKING OPTION
SGM8240-1	SC70-5	-40°C to +125°C	SGM8240-1XC5G/TR	G88XX	Tape and Reel, 3000
	SOT-23-5	-40°C to +125°C	SGM8240-1AXN5G/TR	G1CXX	Tape and Reel, 3000
	SOT-23-5	-40°C to +125°C	SGM8240-1BXN5G/TR	G89XX	Tape and Reel, 3000
SGM8240-2	SOIC-8	-40°C to +125°C	SGM8240-2XS8G/TR	SGM 82402XS8 XXXXX	Tape and Reel, 2500
	MSOP-8	-40°C to +125°C	SGM8240-2XMS8G/TR	SGM82402 XMS8 XXXXX	Tape and Reel, 4000
	TDFN-2×3-8L	-40°C to +125°C	SGM8240-2XTDC8G/TR	G8C XXXX	Tape and Reel, 3000
SGM8240-4	SOIC-14	-40°C to +125°C	SGM8240-4XS14G/TR	SGM82404XS14 XXXXX	Tape and Reel, 2500

MARKING INFORMATION

NOTE: XX = Date Code. XXXX = Date Code. XXXXX = Date Code and Vendor Code.

SC70-5/SOT-23-5

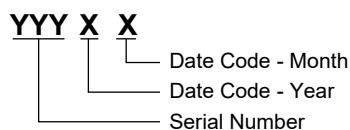

SOIC-8/MSOP-8/SOIC-14

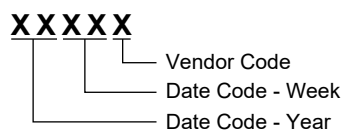

TDFN-2×3-8L

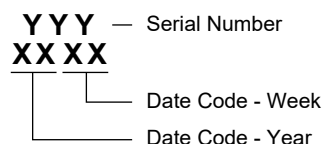

Green (RoHS & HSF): SG Micro Corp defines "Green" to mean Pb-Free (RoHS compatible) and free of halogen substances. If you have additional comments or questions, please contact your SGMICRO representative directly.

ABSOLUTE MAXIMUM RATINGS

Supply Voltage, +V _S to -V _S	26V
Signal Input Terminals, Voltage	(-V _S) - 0.3V to (+V _S) + 0.3V
Signal Input Terminals, Current	±10mA
Output Short-Circuit Current	±20mA
Junction Temperature	+150°C
Storage Temperature Range	-65°C to +150°C
Lead Temperature (Soldering, 10s)	+260°C
ESD Susceptibility	
HBM	8000V
MM	200V
CDM	1000V

RECOMMENDED OPERATING CONDITIONS

Input Voltage Range	2.7V to 24V
Operating Temperature Range	-40°C to +125°C

OVERSTRESS CAUTION

Stresses beyond those listed in Absolute Maximum Ratings may cause permanent damage to the device. Exposure to absolute maximum rating conditions for extended periods may affect reliability. Functional operation of the device at any conditions beyond those indicated in the Recommended Operating Conditions section is not implied.

ESD SENSITIVITY CAUTION

This integrated circuit can be damaged if ESD protections are not considered carefully. SGMICRO recommends that all integrated circuits be handled with appropriate precautions. Failure to observe proper handling and installation procedures can cause damage. ESD damage can range from subtle performance degradation to complete device failure. Precision integrated circuits may be more susceptible to damage because even small parametric changes could cause the device not to meet the published specifications.

DISCLAIMER

SG Micro Corp reserves the right to make any change in circuit design, or specifications without prior notice.

PIN CONFIGURATIONS

SGM8240-1AXN5G (TOP VIEW)

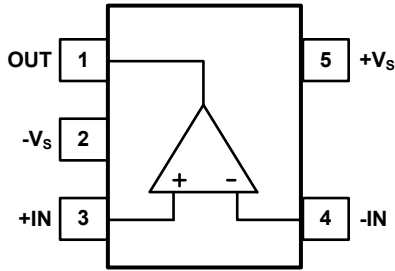

SOT-23-5

SGM8240-1BXN5G/SGM8240-1XC5G (TOP VIEW)

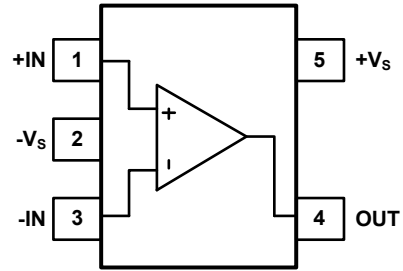

SOT-23-5/SC70-5

SGM8240-2 (TOP VIEW)

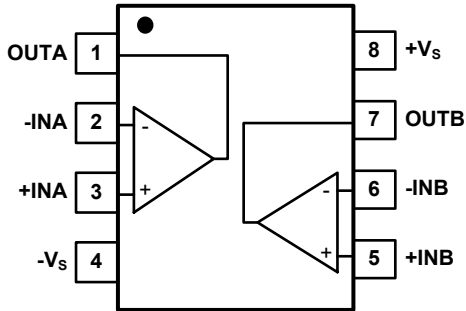

SOIC-8/MSOP-8

SGM8240-2 (TOP VIEW)

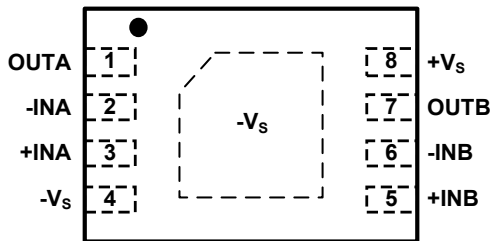

TDFN-2x3-8L

SGM8240-4 (TOP VIEW)

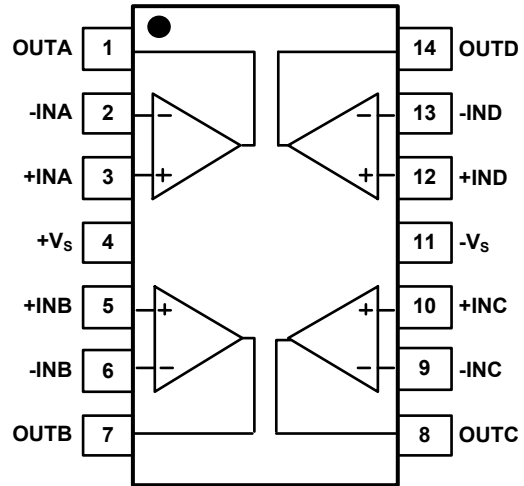

SOIC-14

ELECTRICAL CHARACTERISTICS

(At $T_A = +25^\circ\text{C}$, $V_S = 2.7\text{V}$ to 24V , $R_L = 25\text{k}\Omega$ connected to $V_S/2$, and $V_{CM} < (+V_S) - 1\text{V}$, Full = -40°C to $+125^\circ\text{C}$, unless otherwise noted.)

PARAMETER	SYMBOL	CONDITIONS	TEMP	MIN	TYP	MAX	UNITS
Input Characteristics							
Input Offset Voltage	V_{OS}		+25°C		0.4	1	mV
			Full			4.8	
Input Offset Voltage Drift	$\Delta V_{OS}/\Delta T$		+25°C		3		$\mu\text{V}/^\circ\text{C}$
Input Bias Current	I_B	$V_{CM} = V_S/2$	+25°C		± 5		pA
Input Offset Current	I_{OS}	$V_{CM} = V_S/2$	+25°C		± 5		pA
Input Common Mode Voltage Range	V_{CM}		+25°C	$(-V_S) - 0.1$		$(+V_S) + 0.1$	V
Common Mode Rejection Ratio	CMRR	$V_S = 24\text{V}$, $(-V_S) < V_{CM} < (+V_S) - 1\text{V}$	+25°C	96	110		dB
			Full	57			
Open-Loop Voltage Gain	A_{OL}	$R_L = 25\text{k}\Omega$, $(-V_S) + 0.2\text{V} < V_{OUT} < (+V_S) - 0.2\text{V}$	+25°C	98	120		dB
			Full	60			
		$R_L = 5\text{k}\Omega$, $(-V_S) + 0.6\text{V} < V_{OUT} < (+V_S) - 0.6\text{V}$	+25°C	94	110		
			Full	63			
Output Characteristics							
Output Voltage Swing from Rail	V_{OUT}	$V_S = 24\text{V}$, $R_L = 25\text{k}\Omega$	+25°C		55	98	mV
			Full			130	
		$V_S = 24\text{V}$, $R_L = 5\text{k}\Omega$	+25°C		230	345	
			Full			475	
Output Short-Circuit Current	I_{SC}		+25°C	± 11	± 20		mA
Power Supply							
Operating Voltage Range	V_S		+25°C	2.7		24	V
Quiescent Current/Amplifier	I_Q	$I_{OUT} = 0\text{A}$	+25°C		2.8	4.2	μA
			Full			5.5	
Power Supply Rejection Ratio	PSRR		+25°C	97	116		dB
			Full	73			
Dynamic Performance ($C_L = 30\text{pF}$)							
Gain-Bandwidth Product	GBP		+25°C		100		kHz
Slew Rate	SR	$G = +1$	+25°C		0.05		$\text{V}/\mu\text{s}$
Overload Recovery Time		$V_{IN} \times G > V_S$	+25°C		40		μs
Noise							
Input Voltage Noise		$f = 0.1\text{Hz}$ to 10Hz	+25°C		3		μV_{P-P}
Input Voltage Noise Density	e_n	$f = 1\text{kHz}$	+25°C		100		$\text{nV}/\sqrt{\text{Hz}}$
Input Current Noise Density	i_n	$f = 1\text{kHz}$	+25°C		3.5		$\text{pA}/\sqrt{\text{Hz}}$

TYPICAL PERFORMANCE CHARACTERISTICS

At $T_A = +25^\circ\text{C}$, $V_S = 24\text{V}$, $R_L = 25\text{k}\Omega$, unless otherwise noted.

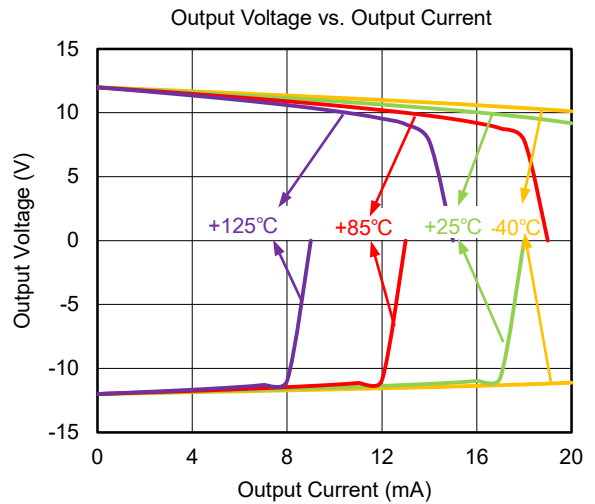
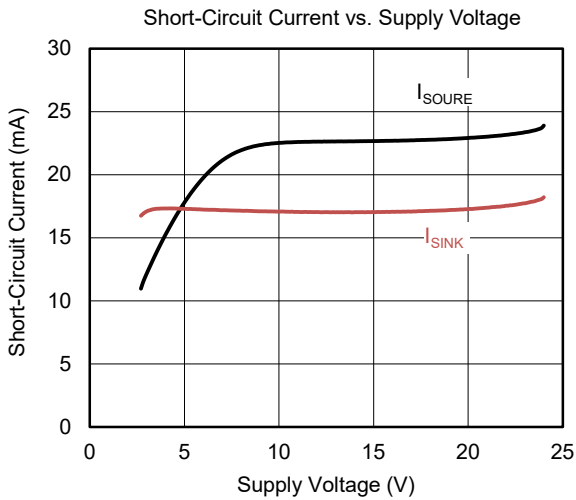
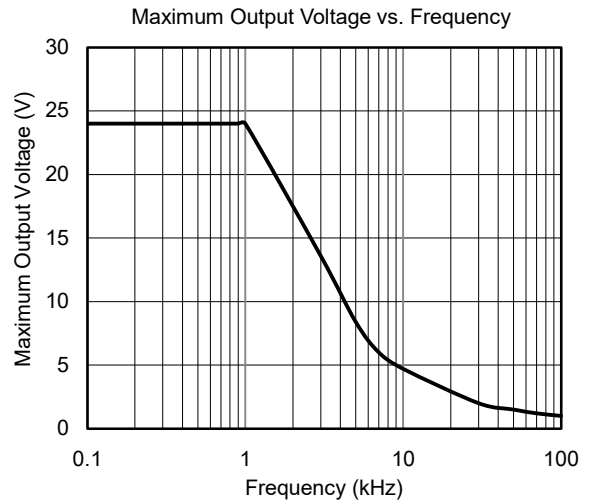
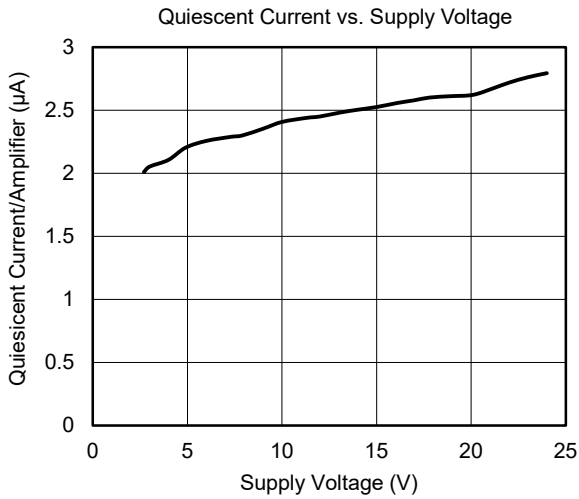
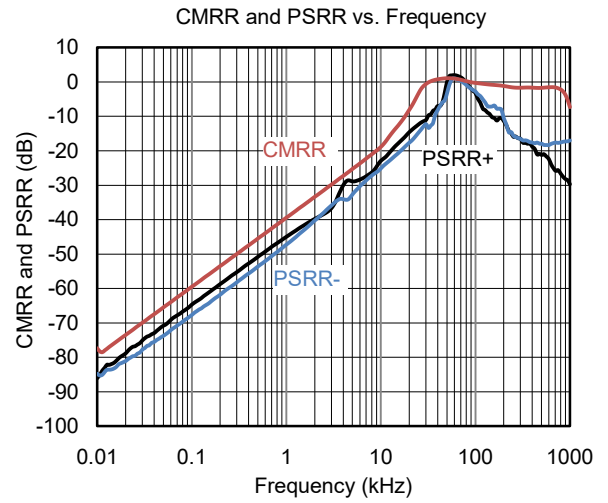
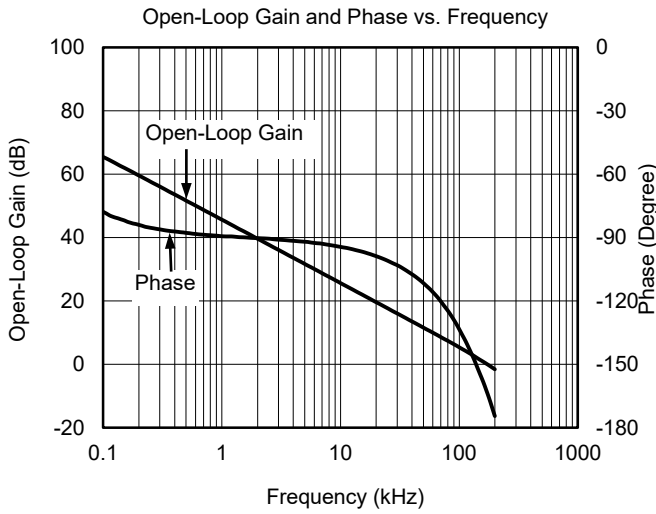

TYPICAL PERFORMANCE CHARACTERISTICS (continued)

At $T_A = +25^\circ\text{C}$, $V_S = 24\text{V}$, $R_L = 25\text{k}\Omega$, unless otherwise noted.

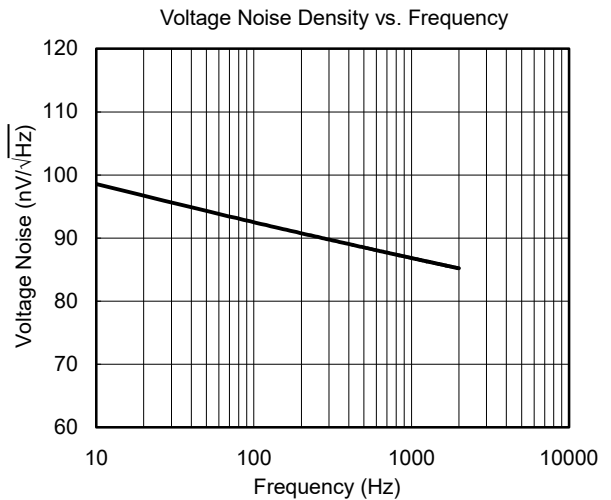
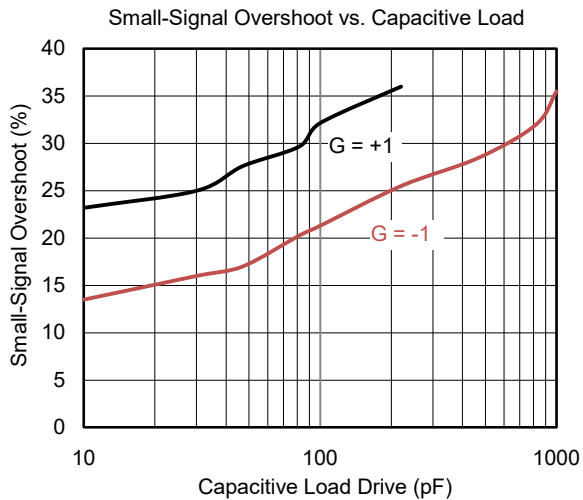
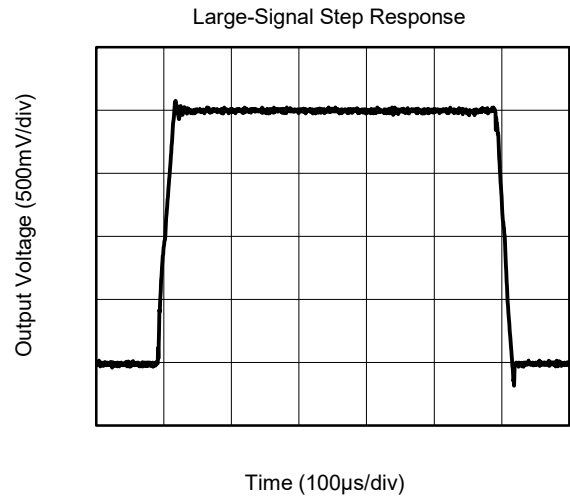
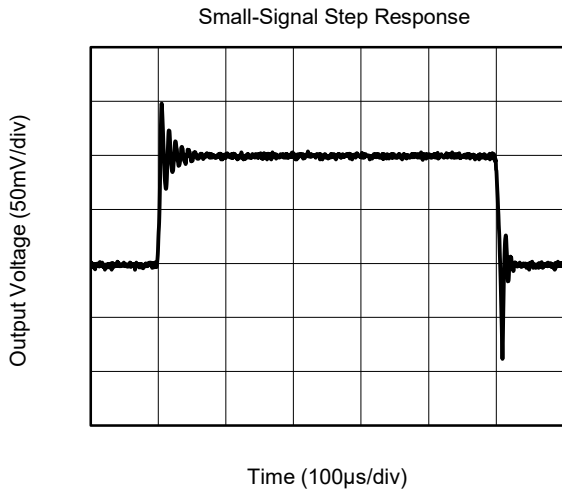
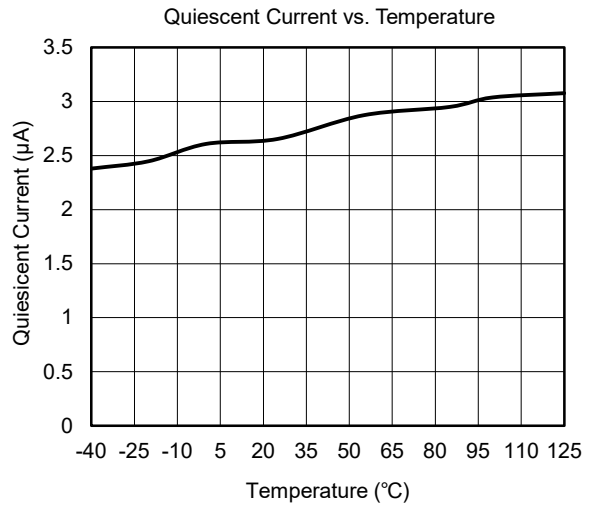
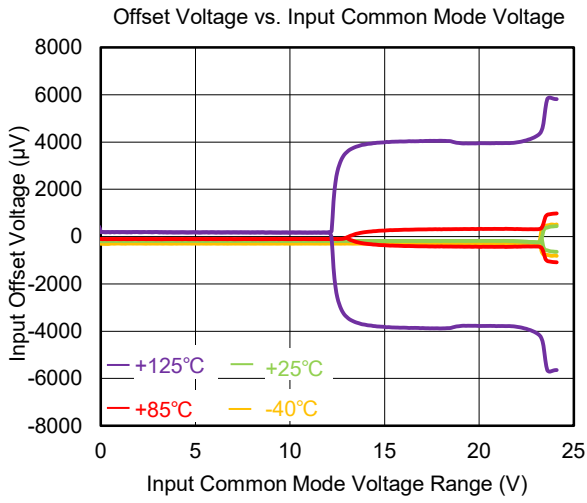

TYPICAL PERFORMANCE CHARACTERISTICS (continued)

At $T_A = +25^\circ\text{C}$, $V_S = 24\text{V}$, $R_L = 25\text{k}\Omega$, unless otherwise noted.

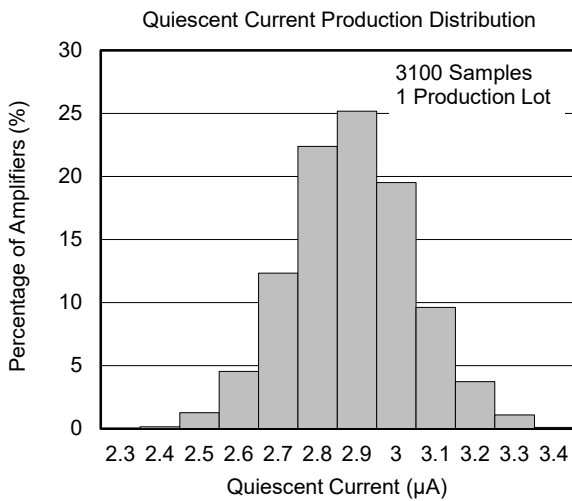
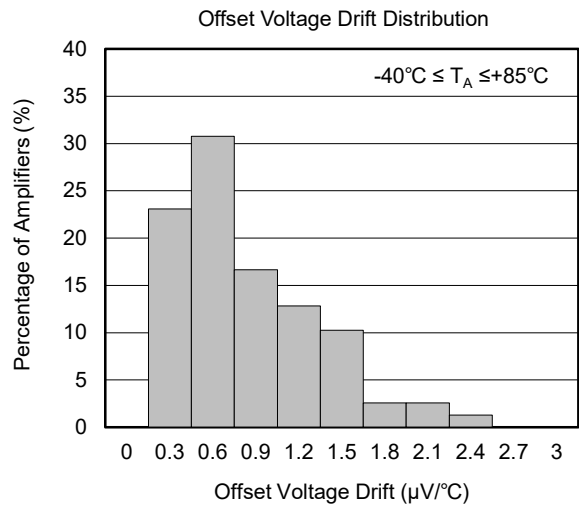
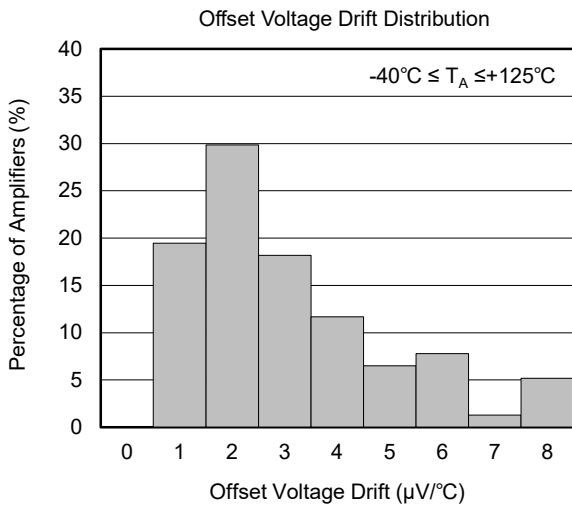
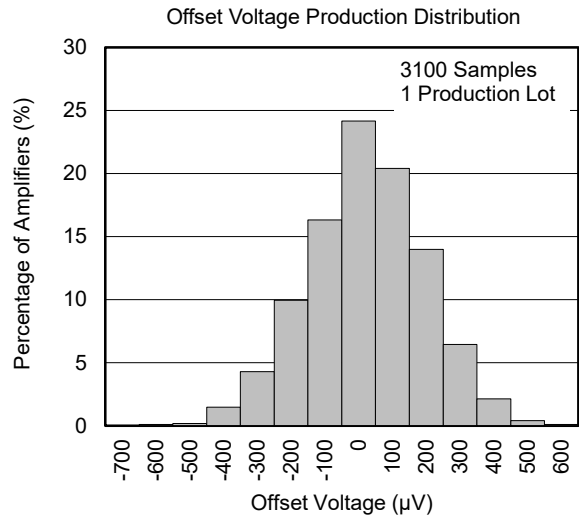
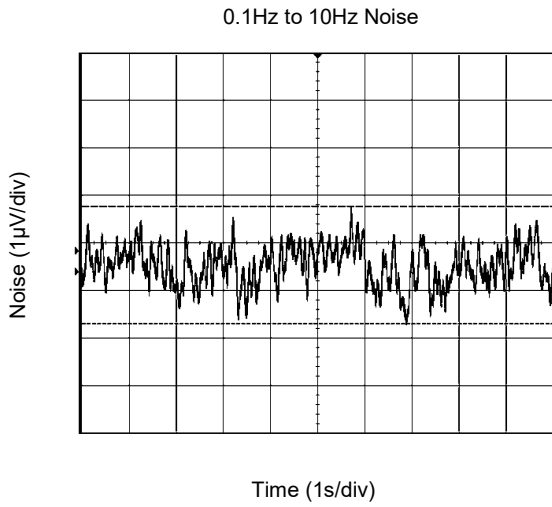

REVISION HISTORY

NOTE: Page numbers for previous revisions may differ from page numbers in the current version.

Changes from Original (DECEMBER 2016) to REV.A

Page

Changed from product preview to production data.....	All
--	-----

PACKAGE OUTLINE DIMENSIONS

SOT-23-5

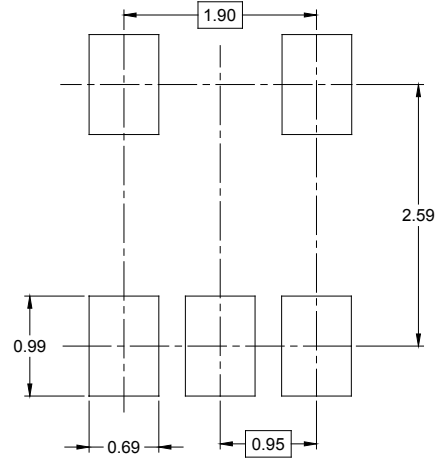

RECOMMENDED LAND PATTERN (Unit: mm)



Symbol	Dimensions In Millimeters		Dimensions In Inches	
	MIN	MAX	MIN	MAX
A	1.050	1.250	0.041	0.049
A1	0.000	0.100	0.000	0.004
A2	1.050	1.150	0.041	0.045
b	0.300	0.500	0.012	0.020
c	0.100	0.200	0.004	0.008
D	2.820	3.020	0.111	0.119
E	1.500	1.700	0.059	0.067
E1	2.650	2.950	0.104	0.116
e	0.950 BSC		0.037 BSC	
e1	1.900 BSC		0.075 BSC	
L	0.300	0.600	0.012	0.024
θ	0°	8°	0°	8°

PACKAGE OUTLINE DIMENSIONS

SC70-5

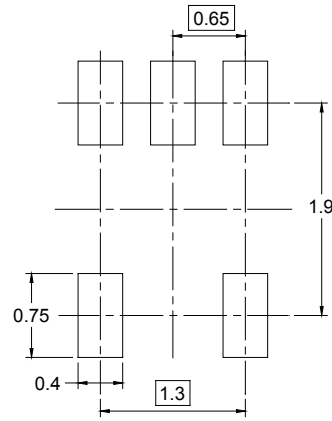
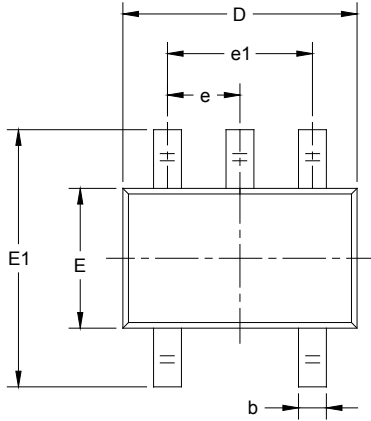

RECOMMENDED LAND PATTERN (Unit: mm)

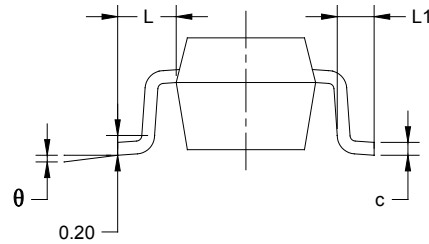
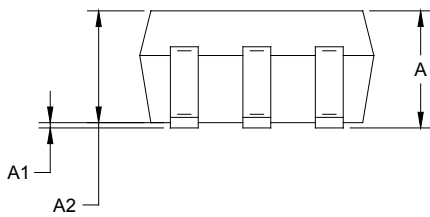

Symbol	Dimensions In Millimeters		Dimensions In Inches	
	MIN	MAX	MIN	MAX
A	0.900	1.100	0.035	0.043
A1	0.000	0.100	0.000	0.004
A2	0.900	1.000	0.035	0.039
b	0.150	0.350	0.006	0.014
c	0.080	0.150	0.003	0.006
D	2.000	2.200	0.079	0.087
E	1.150	1.350	0.045	0.053
E1	2.150	2.450	0.085	0.096
e	0.65 TYP		0.026 TYP	
e1	1.300 BSC		0.051 BSC	
L	0.525 REF		0.021 REF	
L1	0.260	0.460	0.010	0.018
θ	0°	8°	0°	8°

PACKAGE OUTLINE DIMENSIONS

SOIC-8

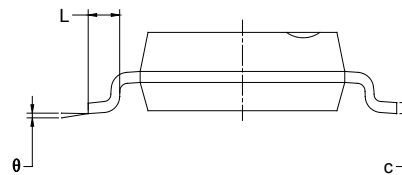
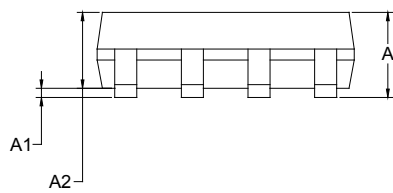
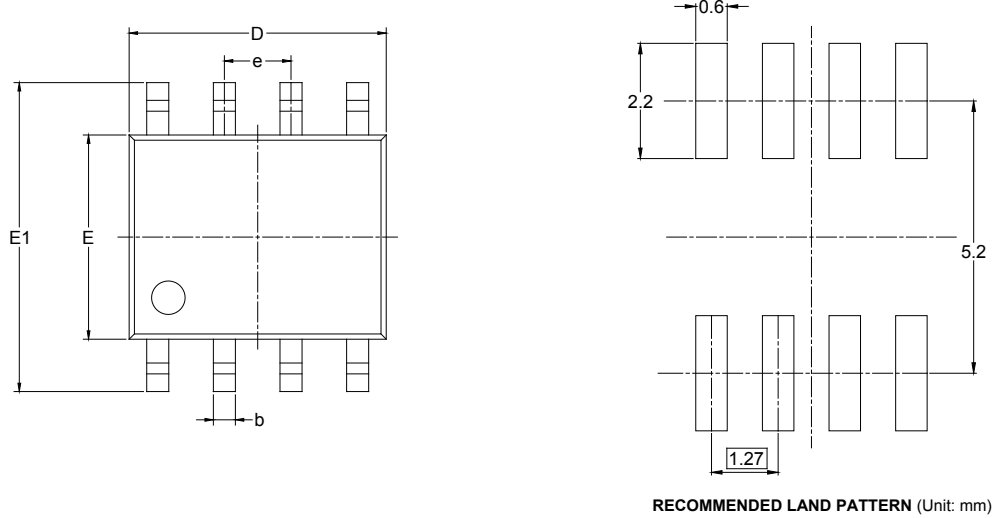

Symbol	Dimensions In Millimeters		Dimensions In Inches	
	MIN	MAX	MIN	MAX
A	1.350	1.750	0.053	0.069
A1	0.100	0.250	0.004	0.010
A2	1.350	1.550	0.053	0.061
b	0.330	0.510	0.013	0.020
c	0.170	0.250	0.006	0.010
D	4.700	5.100	0.185	0.200
E	3.800	4.000	0.150	0.157
E1	5.800	6.200	0.228	0.244
e	1.27 BSC		0.050 BSC	
L	0.400	1.270	0.016	0.050
θ	0°	8°	0°	8°

PACKAGE OUTLINE DIMENSIONS

MSOP-8

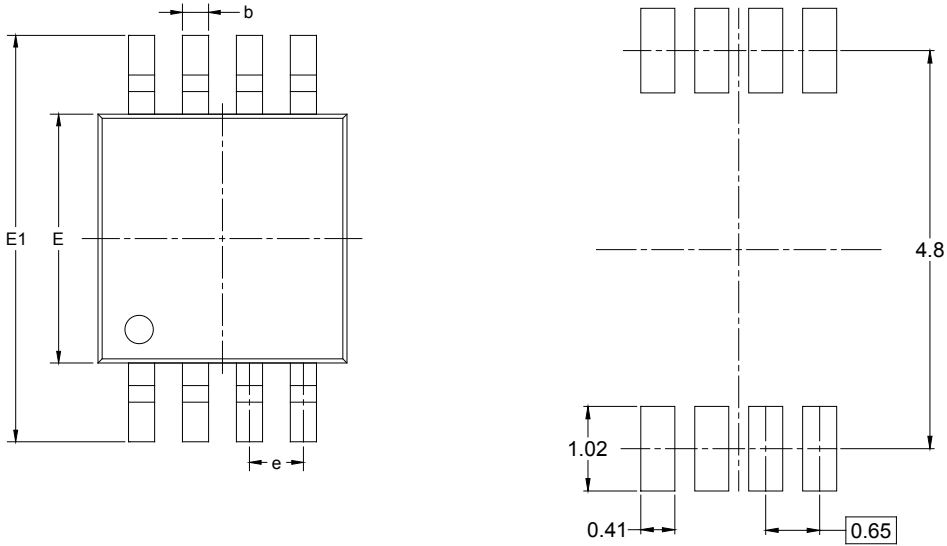

RECOMMENDED LAND PATTERN (Unit: mm)

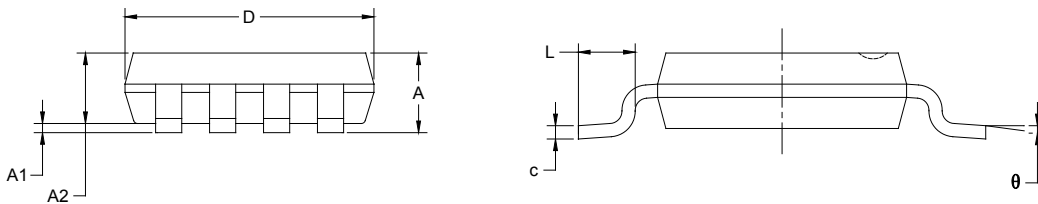

Symbol	Dimensions In Millimeters		Dimensions In Inches	
	MIN	MAX	MIN	MAX
A	0.820	1.100	0.032	0.043
A1	0.020	0.150	0.001	0.006
A2	0.750	0.950	0.030	0.037
b	0.250	0.380	0.010	0.015
c	0.090	0.230	0.004	0.009
D	2.900	3.100	0.114	0.122
E	2.900	3.100	0.114	0.122
E1	4.750	5.050	0.187	0.199
e	0.650 BSC		0.026 BSC	
L	0.400	0.800	0.016	0.031
θ	0°	6°	0°	6°

PACKAGE OUTLINE DIMENSIONS

TDFN-2x3-8L

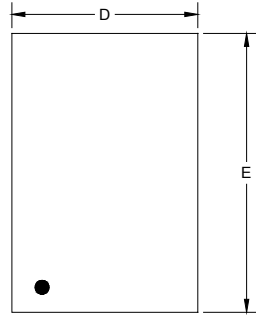

TOP VIEW

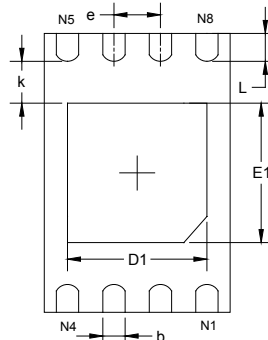

BOTTOM VIEW

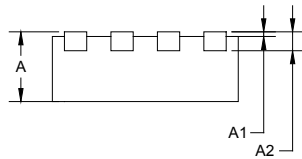

SIDE VIEW

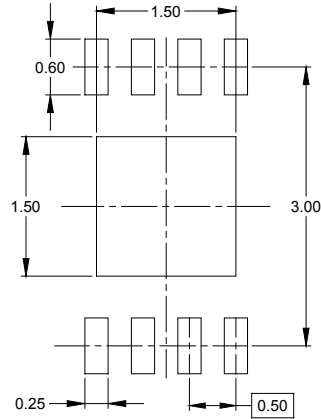

RECOMMENDED LAND PATTERN (Unit: mm)

Symbol	Dimensions In Millimeters		Dimensions In Inches	
	MIN	MAX	MIN	MAX
A	0.700	0.800	0.028	0.031
A1	0.000	0.050	0.000	0.002
A2	0.203 REF		0.008 REF	
D	1.924	2.076	0.076	0.082
D1	1.400	1.600	0.055	0.063
E	2.924	3.076	0.115	0.121
E1	1.400	1.600	0.055	0.063
k	0.200 MIN		0.008 MIN	
b	0.200	0.300	0.008	0.012
e	0.500 TYP		0.020 TYP	
L	0.224	0.376	0.009	0.015

PACKAGE INFORMATION

PACKAGE OUTLINE DIMENSIONS

SOIC-14

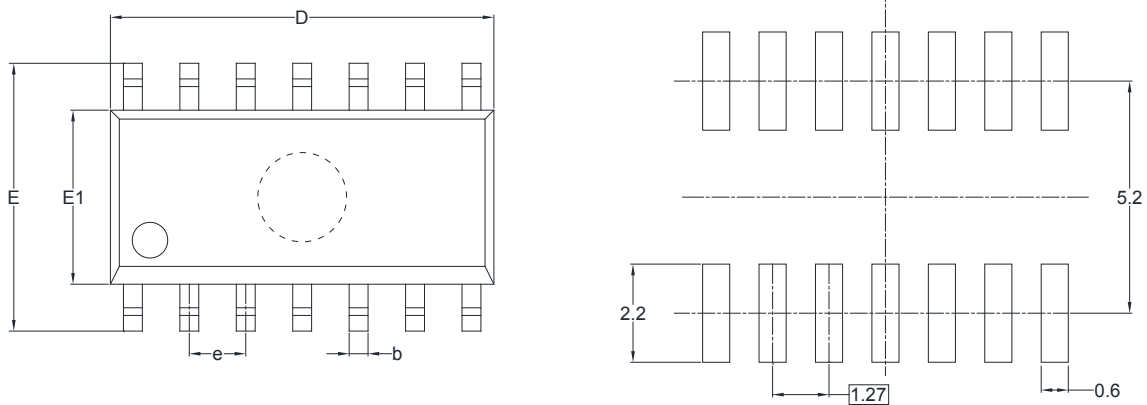

RECOMMENDED LAND PATTERN (Unit: mm)

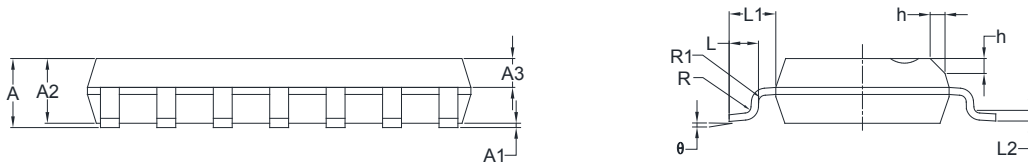

Symbol	Dimensions In Millimeters		Dimensions In Inches	
	MIN	MAX	MIN	MAX
A	1.35	1.75	0.053	0.069
A1	0.10	0.25	0.004	0.010
A2	1.25	1.65	0.049	0.065
A3	0.55	0.75	0.022	0.030
b	0.36	0.49	0.014	0.019
D	8.53	8.73	0.336	0.344
E	5.80	6.20	0.228	0.244
E1	3.80	4.00	0.150	0.157
e	1.27 BSC		0.050 BSC	
L	0.45	0.80	0.018	0.032
L1	1.04 REF		0.040 REF	
L2	0.25 BSC		0.01 BSC	
R	0.07		0.003	
R1	0.07		0.003	
h	0.30	0.50	0.012	0.020
θ	0°	8°	0°	8°

PACKAGE INFORMATION

TAPE AND REEL INFORMATION

REEL DIMENSIONS

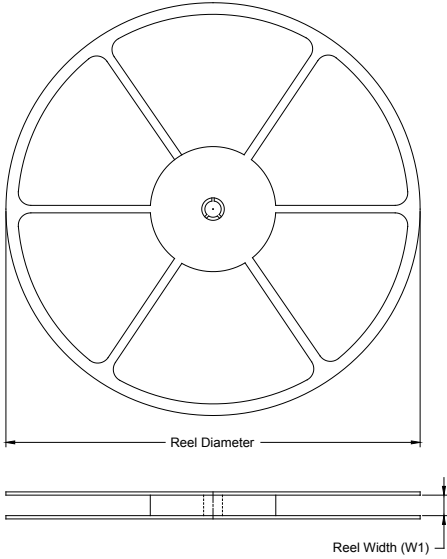

TAPE DIMENSIONS

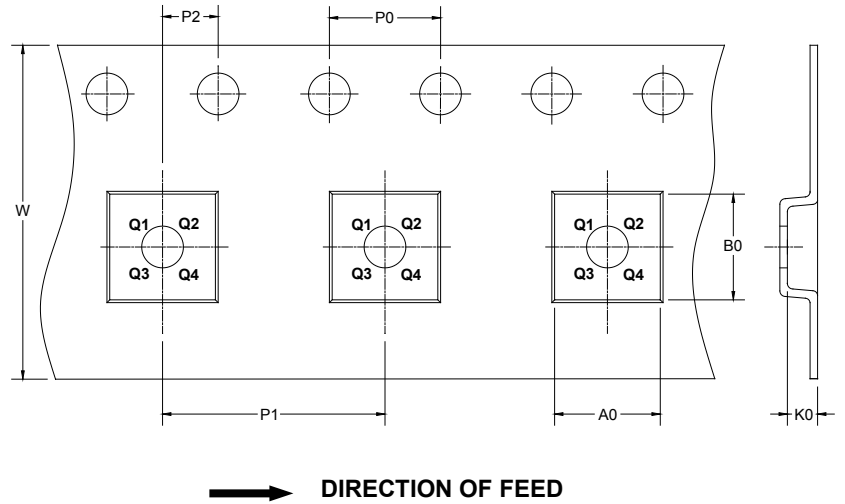

NOTE: The picture is only for reference. Please make the object as the standard.

KEY PARAMETER LIST OF TAPE AND REEL

Package Type	Reel Diameter	Reel Width W1 (mm)	A0 (mm)	B0 (mm)	K0 (mm)	P0 (mm)	P1 (mm)	P2 (mm)	W (mm)	Pin1 Quadrant
SC70-5	7"	9.5	2.25	2.55	1.20	4.0	4.0	2.0	8.0	Q3
SOT-23-5	7"	9.5	3.20	3.20	1.40	4.0	4.0	2.0	8.0	Q3
SOIC-8	13"	12.4	6.40	5.40	2.10	4.0	8.0	2.0	12.0	Q1
MSOP-8	13"	12.4	5.20	3.30	1.50	4.0	8.0	2.0	12.0	Q1
TDFN-2×3-8L	7"	9.5	2.30	3.30	1.10	4.0	4.0	2.0	8.0	Q2
SOIC-14	13"	16.4	6.60	9.30	2.10	4.0	8.0	2.0	16.0	Q1

D00001

PACKAGE INFORMATION

CARTON BOX DIMENSIONS



NOTE: The picture is only for reference. Please make the object as the standard.

KEY PARAMETER LIST OF CARTON BOX

Reel Type	Length (mm)	Width (mm)	Height (mm)	Pizza/Carton
7" (Option)	368	227	224	8
7"	442	410	224	18
13"	386	280	370	5

DD0002

单击下面可查看定价，库存，交付和生命周期等信息

[>>SGMICRO\(圣邦微电子\)](#)