



74AVC16T245

16-Bit Dual-Supply Translating Transceiver with Configurable Voltage Translation and 3-State Outputs

GENERAL DESCRIPTION

The 74AVC16T245 is a 16-bit dual-supply translating transceiver with configurable voltage translation and 3-state outputs. The device can be used as two 8-bit transceivers or one 16-bit transceiver. The nAn and nBn are two 8-bit input-output data ports. nDIR are the direction control inputs and \overline{nOE} are the output enable inputs. V_{CCA} and V_{CCB} are the supply pins. The supply voltage of V_{CCA} and V_{CCB} can range from 0.8V to 3.6V, making the device suitable for bidirectional translating among any of the 0.8V, 1.2V, 1.5V, 1.8V, 2.5V and 3.3V voltage nodes. The nAn, nDIR and \overline{nOE} signals are referenced to V_{CCA} and nBn signals are referenced to V_{CCB} .

When nDIR is set high, it allows transmission from nAn to nBn. When nDIR is set low, it allows transmission from nBn to nAn. \overline{nOE} can be used to make the outputs disabled so that the buses are effectively isolated. In suspend mode, both nAn and nBn are in the high-impedance state when either V_{CCA} or V_{CCB} input is at GND level.

This device is highly suitable for partial power-down applications using power-off leakage current (I_{OFF}) circuit. When the device is powered down, the current backflow will be prevented from passing through the device.

FEATURES

- V_{CCA} Supply Voltage Range: 0.8V to 3.6V
- V_{CCB} Supply Voltage Range: 0.8V to 3.6V
- Inputs Accept Voltages up to 3.6V
- +12mA/-12mA Output Current
- Data Rates:
 - ◆ 380Mbps ($\geq 1.8V$ to 3.3V Translation)
 - ◆ 200Mbps ($\geq 1.1V$ to 3.3V Translation)
 - ◆ 200Mbps ($\geq 1.1V$ to 2.5V Translation)
 - ◆ 200Mbps ($\geq 1.1V$ to 1.8V Translation)
 - ◆ 150Mbps ($\geq 1.1V$ to 1.5V Translation)
 - ◆ 100Mbps ($\geq 1.1V$ to 1.2V Translation)
- Outputs in High-Impedance State when V_{CCA} or $V_{CCB} = 0V$
- $-40^{\circ}C$ to $+125^{\circ}C$ Operating Temperature Range
- Available in a Green TSSOP-48 Package

16-Bit Dual-Supply Translating Transceiver with 74AVC16T245 Configurable Voltage Translation and 3-State Outputs

PACKAGE/ORDERING INFORMATION

MODEL	PACKAGE DESCRIPTION	SPECIFIED TEMPERATURE RANGE	ORDERING NUMBER	PACKAGE MARKING	PACKING OPTION
74AVC16T245	TSSOP-48	-40°C to +125°C	74AVC16T245XTS48G/TR	74AVC16T245 XTS48 XXXXX	Tape and Reel, 2500

MARKING INFORMATION

NOTE: XXXXX = Date Code, Trace Code and Vendor Code.

XXXXX

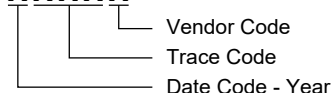

Green (RoHS & HSF): SG Micro Corp defines "Green" to mean Pb-Free (RoHS compatible) and free of halogen substances. If you have additional comments or questions, please contact your SGMICRO representative directly.

ABSOLUTE MAXIMUM RATINGS ⁽¹⁾

Supply Voltage Range, V_{CCA}	-0.5V to 4.6V
Supply Voltage Range, V_{CCB}	-0.5V to 4.6V
Input Voltage Range, V_I ⁽²⁾	-0.5V to 4.6V
Output Voltage Range, V_O ⁽²⁾	
Suspend or 3-State Mode	-0.5V to 4.6V
Active Mode	
A Ports	-0.5V to MIN (4.6V, $V_{CCA} + 0.5V$)
B Ports	-0.5V to MIN (4.6V, $V_{CCB} + 0.5V$)
Output Current, I_O ($V_O = 0V$ to V_{CC})	
High-State or Low-State	$\pm 50mA$
Supply Current, I_{CC} , per V_{CCA} or V_{CCB} Pin	100mA
Ground Current, I_{GND} , per GND Pin	-100mA
Input Clamp Current, I_{IK} ($V_I < 0$).....	-50mA
Output Clamp Current, I_{OK} ($V_O < 0$).....	-50mA
Continuous Output Current.....	$\pm 50mA$
Junction Temperature ⁽³⁾	+150°C
Storage Temperature Range	-65°C to +150°C
Lead Temperature (Soldering, 10s).....	+260°C
ESD Susceptibility	
HBM.....	8000V
CDM	1000V

RECOMMENDED OPERATING CONDITIONS

Supply Voltage Range, V_{CCA}	0.8V to 3.6V
Supply Voltage Range, V_{CCB}	0.8V to 3.6V
Input Voltage Range, V_I	0V to 3.6V
Output Voltage Range, V_O	
Suspend or 3-State Mode	0V to 3.6V
Active Mode	
A Ports	0V to V_{CCA}
B Ports	0V to V_{CCB}
High-State or Low-State Output Current, I_O	$\pm 12mA$

Input Transition Rise and Fall Rate, $\Delta t/\Delta V$

$V_{CCI} = 0.8V$ to 3.6V	10ns/V (MAX)
Operating Temperature Range.....	-40°C to +125°C

OVERSTRESS CAUTION

- Stresses beyond those listed in Absolute Maximum Ratings may cause permanent damage to the device. Exposure to absolute maximum rating conditions for extended periods may affect reliability. Functional operation of the device at any conditions beyond those indicated in the Recommended Operating Conditions section is not implied.
- The minimum input voltage ratings and output voltage ratings may be exceeded if the input and output current ratings are observed.
- The performance capability of a high-performance integrated circuit in conjunction with its thermal environment can create junction temperatures which are detrimental to reliability.

ESD SENSITIVITY CAUTION

This integrated circuit can be damaged if ESD protections are not considered carefully. SGMICRO recommends that all integrated circuits be handled with appropriate precautions. Failure to observe proper handling and installation procedures can cause damage. ESD damage can range from subtle performance degradation to complete device failure. Precision integrated circuits may be more susceptible to damage because even small parametric changes could cause the device not to meet the published specifications.

DISCLAIMER

SG Micro Corp reserves the right to make any change in circuit design, or specifications without prior notice.

74AVC16T245 16-Bit Dual-Supply Translating Transceiver with Configurable Voltage Translation and 3-State Outputs

LOGIC SYMBOL

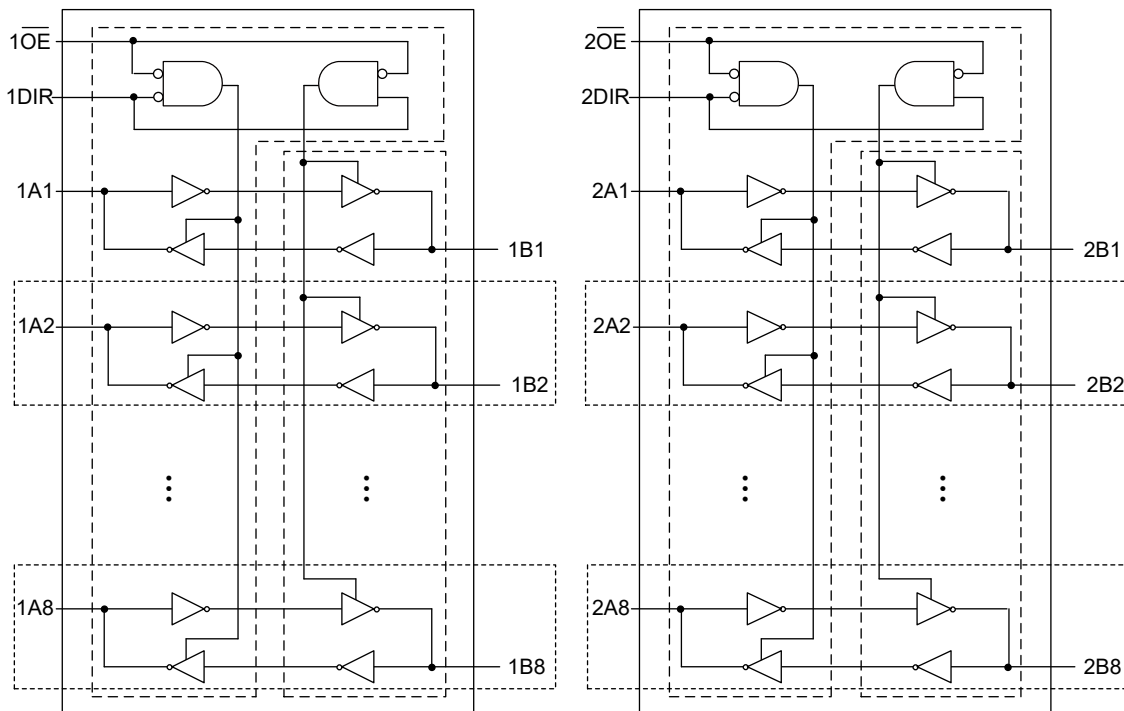

FUNCTION TABLE

SUPPLY VOLTAGE	CONTROL INPUT		INPUT/OUTPUT	
	$V_{CCA}, V_{CCB}^{(1)}$	$n\overline{OE}$	$nDIR$	nAn
0.8V to 3.6V	L	L	$nAn = nBn$	Inputs
0.8V to 3.6V	L	H	Inputs	$nBn = nAn$
0.8V to 3.6V	H	X	Z	Z
GND ⁽²⁾	X	X	Z	Z

H = High Voltage Level
 L = Low Voltage Level
 Z = High-Impedance State
 X = Don't Care

NOTES:

- The nAn , $nDIR$ and $n\overline{OE}$ signals are referenced to V_{CCA} . The nBn signals are referenced to V_{CCB} .
- If at least one of V_{CCA} or V_{CCB} is at GND level, the device enters suspend mode.

74AVC16T245 16-Bit Dual-Supply Translating Transceiver with Configurable Voltage Translation and 3-State Outputs

PIN CONFIGURATION

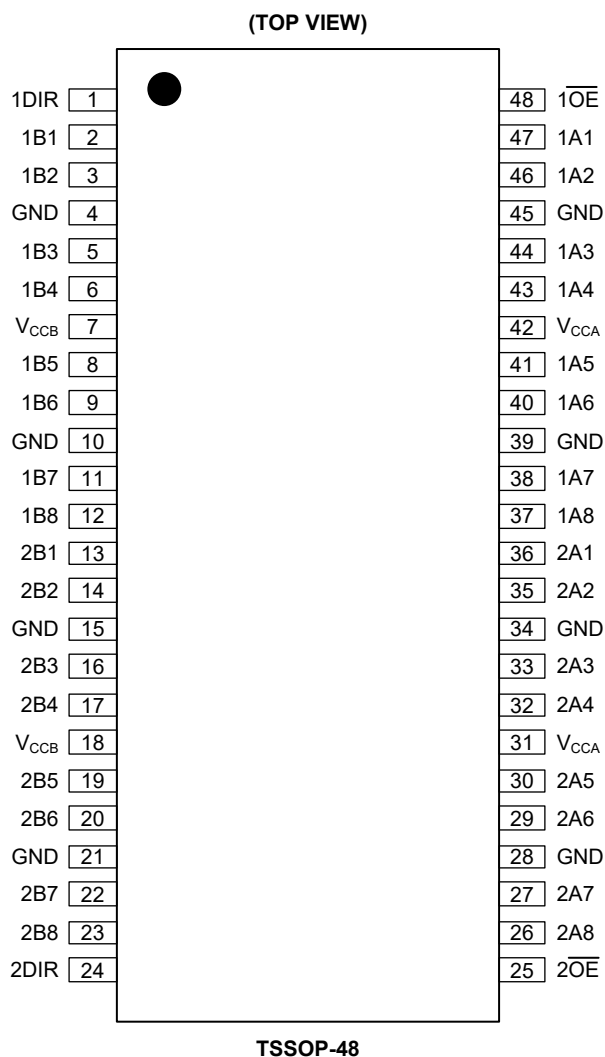

PIN DESCRIPTION

PIN	NAME	FUNCTION
1, 24	1DIR, 2DIR	Direction Control Inputs.
2, 3, 5, 6, 8, 9, 11, 12	1B1, 1B2, 1B3, 1B4, 1B5, 1B6, 1B7, 1B8	Data Inputs/Outputs.
13, 14, 16, 17, 19, 20, 22, 23	2B1, 2B2, 2B3, 2B4, 2B5, 2B6, 2B7, 2B8	Data Inputs/Outputs.
4, 10, 15, 21, 28, 34, 39, 45	GND	Ground.
7, 18	V _{CCB}	Supply Voltage V _{CCB} . The nBn signals are referenced to V _{CCB} .
48, 25	1OE, 2OE	Output Enable Inputs (Active Low).
47, 46, 44, 43, 41, 40, 38, 37	1A1, 1A2, 1A3, 1A4, 1A5, 1A6, 1A7, 1A8	Data Inputs/Outputs.
36, 35, 33, 32, 30, 29, 27, 26	2A1, 2A2, 2A3, 2A4, 2A5, 2A6, 2A7, 2A8	Data Inputs/Outputs.
31, 42	V _{CCA}	Supply Voltage V _{CCA} . The nAn, nDIR and nOE signals are referenced to V _{CCA} .

PACKAGE INFORMATION

PACKAGE OUTLINE DIMENSIONS

TSSOP-48

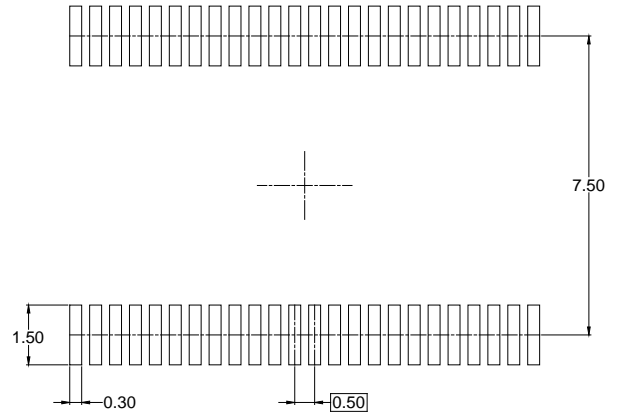
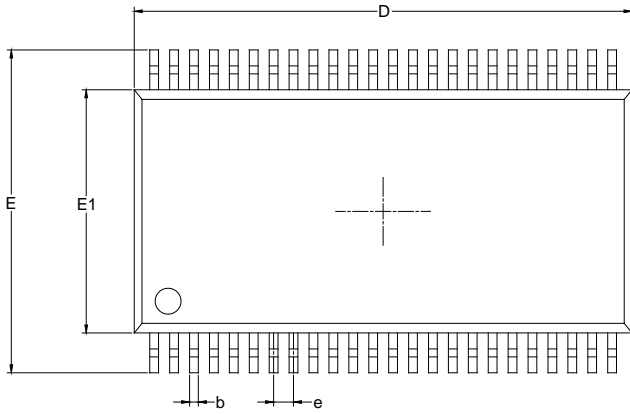

RECOMMENDED LAND PATTERN (Unit: mm)

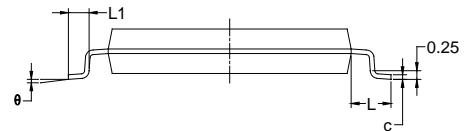
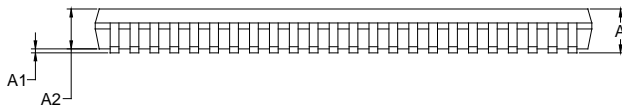

Symbol	Dimensions In Millimeters		
	MIN	MOD	MAX
A			1.20
A1	0.05	0.10	0.15
A2	0.85	0.95	1.05
b	0.18		0.26
c	0.15		0.19
D	12.40	12.50	12.60
E	7.90	8.10	8.30
E1	6.00	6.10	6.20
e	0.50 BSC		
L	1.00 REF		
L1	0.45		0.75
θ	0°		8°

PACKAGE INFORMATION

TAPE AND REEL INFORMATION

REEL DIMENSIONS

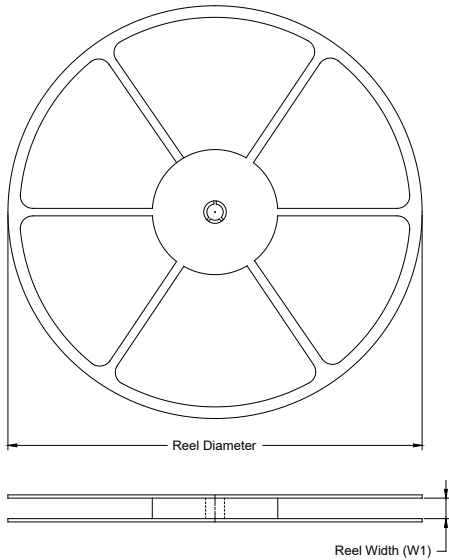

TAPE DIMENSIONS

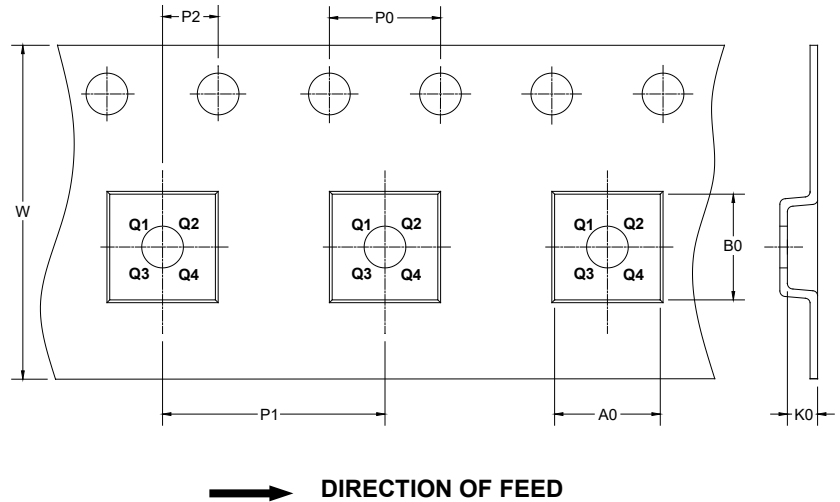

NOTE: The picture is only for reference. Please make the object as the standard.

KEY PARAMETER LIST OF TAPE AND REEL

Package Type	Reel Diameter	Reel Width W1 (mm)	A0 (mm)	B0 (mm)	K0 (mm)	P0 (mm)	P1 (mm)	P2 (mm)	W (mm)	Pin1 Quadrant
TSSOP-48	13"	24.4	8.60	13.00	1.80	4.0	12.0	2.0	24.0	Q1

000001

PACKAGE INFORMATION

CARTON BOX DIMENSIONS



NOTE: The picture is only for reference. Please make the object as the standard.

KEY PARAMETER LIST OF CARTON BOX

Reel Type	Length (mm)	Width (mm)	Height (mm)	Pizza/Carton
13"	386	280	370	5

DD0002

单击下面可查看定价，库存，交付和生命周期等信息

[>>SGMICRO\(圣邦微电子\)](#)