



# SGM8954-1/SGM8954-2

## High Precision, Low Power, Rail-to-Rail I/O, CMOS Operational Amplifiers

### GENERAL DESCRIPTION

The single SGM8954-1 and dual SGM8954-2 are low power, high precision CMOS operational amplifiers, which can operate from 1.8V to 5.5V single supply or from  $\pm 0.9V$  to  $\pm 2.75V$  dual power supplies, while consuming only 9 $\mu A$  quiescent current per amplifier. The SGM8954-1/2 support rail-to-rail input and output operation. The input common mode voltage range is 100mV beyond the rails, and the output swings within 5.5mV of the rails.

The SGM8954-1/2 feature high impedance inputs, a 35 $\mu V$  maximum input offset voltage and zero-drift over time and temperature. These devices are designed to provide optimal performance in low voltage and low power systems. Meanwhile, the SGM8954-1/2 fit in tiny packages. These specifications make the operational amplifiers appropriate for a wide range of applications requiring high precision, such as driving ADCs with high linearity.

The SGM8954-1 is available in Green SOT-23-5, SOIC-8 and UTDFN-1.6 $\times$ 1.6-6L packages. The SGM8954-2 is available in Green SOIC-8, MSOP-8 and TDFN-2 $\times$ 2-8L packages. They are specified over the extended industrial temperature range (-40 $^{\circ}C$  to +125 $^{\circ}C$ ).

### FEATURES

- **Low Offset Voltage:** 8 $\mu V$  (TYP), 35 $\mu V$  (MAX)
- **Low 0.1Hz to 10Hz Noise:** 1 $\mu V_{P-P}$
- **Unity-Gain Stable**
- **Gain-Bandwidth Product:** 110kHz
- **Integrated RFI Filter**
- **Rail-to-Rail Input and Output**
- **Support Single or Dual Power Supplies:**  
1.8V to 5.5V or  $\pm 0.9V$  to  $\pm 2.75V$
- **Quiescent Current:** 9 $\mu A$ /Amplifier (TYP)
- **-40 $^{\circ}C$  to +125 $^{\circ}C$  Operating Temperature Range**
- **Small Packaging:**  
SGM8954-1 Available in Green SOT-23-5, SOIC-8 and UTDFN-1.6 $\times$ 1.6-6L Packages  
SGM8954-2 Available in Green SOIC-8, MSOP-8 and TDFN-2 $\times$ 2-8L Packages

### APPLICATIONS

Temperature Measurements  
Medical Instrumentation  
Transducer Applications  
Electronic Scales  
Handheld Test Equipment  
Battery-Powered Instruments

**PACKAGE/ORDERING INFORMATION**

MODEL	PACKAGE DESCRIPTION	SPECIFIED TEMPERATURE RANGE	ORDERING NUMBER	PACKAGE MARKING	PACKING OPTION
SGM8954-1	SOT-23-5	-40°C to +125°C	SGM8954-1XN5G/TR	MBBXX	Tape and Reel, 3000
	SOIC-8	-40°C to +125°C	SGM8954-1XS8G/TR	SGM 89541XS8 XXXXX	Tape and Reel, 4000
	UTDFN-1.6x1.6-6L	-40°C to +125°C	SGM8954-1XUDN6G/TR	H6X	Tape and Reel, 3000
SGM8954-2	SOIC-8	-40°C to +125°C	SGM8954-2XS8G/TR	SGM 89542XS8 XXXXX	Tape and Reel, 4000
	MSOP-8	-40°C to +125°C	SGM8954-2XMS8G/TR	SGM89542 XMS8 XXXXX	Tape and Reel, 4000
	TDFN-2x2-8L	-40°C to +125°C	SGM8954-2XTDE8G/TR	MH8 XXXX	Tape and Reel, 3000

**MARKING INFORMATION**

NOTE: X = Date Code. XX = Date Code. XXXX = Date Code and Trace Code. XXXXX = Date Code, Trace Code and Vendor Code.

**SOT-23-5**

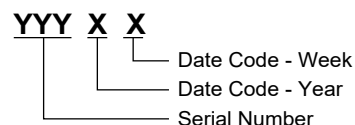

**SOIC-8/MSOP-8**

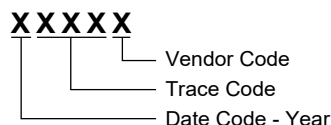

**UTDFN-1.6x1.6-6L**

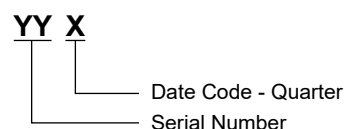

**TDFN-2x2-8L**

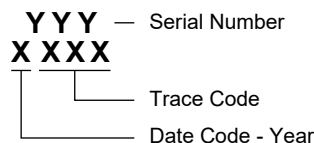

Green (RoHS & HSF): SG Micro Corp defines "Green" to mean Pb-Free (RoHS compatible) and free of halogen substances. If you have additional comments or questions, please contact your SGMICRO representative directly.

# SGM8954-1 SGM8954-2

# High Precision, Low Power, Rail-to-Rail I/O, CMOS Operational Amplifiers

## ABSOLUTE MAXIMUM RATINGS

Supply Voltage.....	6V
Input Common Mode Voltage Range .....	$(-V_s) - 0.3V$ to $(+V_s) + 0.3V$
Junction Temperature .....	+150°C
Storage Temperature Range.....	-65°C to +150°C
Lead Temperature (Soldering, 10s).....	+260°C
ESD Susceptibility	
HBM.....	8000V
MM.....	400V
CDM .....	1000V

## RECOMMENDED OPERATING CONDITIONS

Specified Voltage Range .....	1.8V to 5.5V
Operating Temperature Range .....	-40°C to +125°C

## OVERSTRESS CAUTION

Stresses beyond those listed in Absolute Maximum Ratings may cause permanent damage to the device. Exposure to absolute maximum rating conditions for extended periods may affect reliability. Functional operation of the device at any conditions beyond those indicated in the Recommended Operating Conditions section is not implied.

## ESD SENSITIVITY CAUTION

This integrated circuit can be damaged if ESD protections are not considered carefully. SGMICRO recommends that all integrated circuits be handled with appropriate precautions. Failure to observe proper handling and installation procedures can cause damage. ESD damage can range from subtle performance degradation to complete device failure. Precision integrated circuits may be more susceptible to damage because even small parametric changes could cause the device not to meet the published specifications.

## DISCLAIMER

SG Micro Corp reserves the right to make any change in circuit design, or specifications without prior notice.

## PIN CONFIGURATIONS

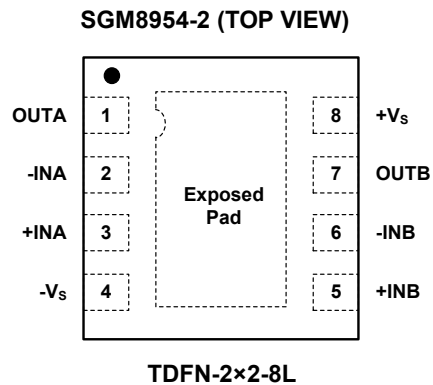
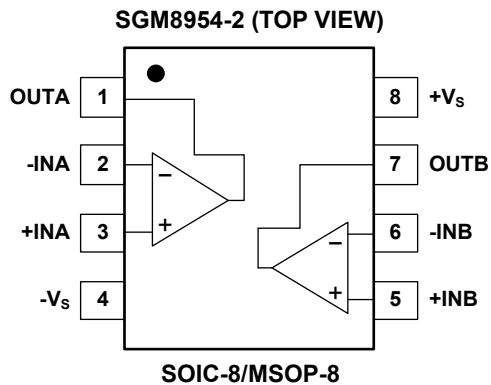
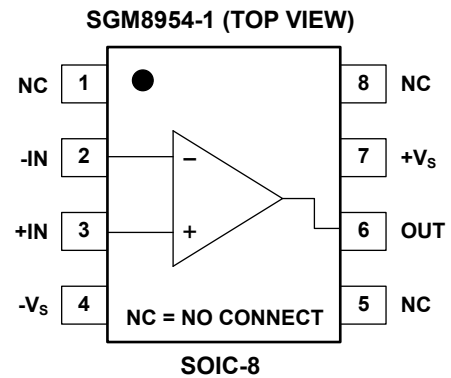
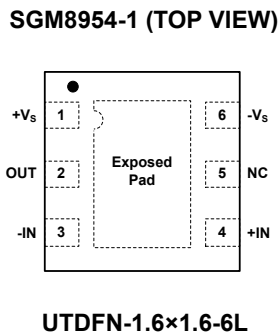
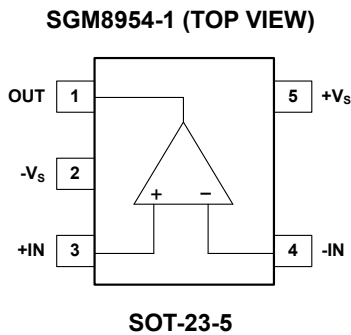

NOTE: For UTDFN-1.6x1.6-6L and TDFN-2x2-8L packages, exposed pad can be connected to -Vs or left floating.

**ELECTRICAL CHARACTERISTICS**

(At  $T_A = +25^\circ\text{C}$ ,  $V_S = 1.8\text{V}$  to  $5.5\text{V}$ ,  $V_{CM} = +V_S/2$ ,  $V_{OUT} = +V_S/2$  and  $R_L = 10\text{k}\Omega$  to  $+V_S/2$ , Full =  $-40^\circ\text{C}$  to  $+125^\circ\text{C}$ , unless otherwise noted.)

PARAMETER	SYMBOL	CONDITIONS	TEMP	MIN	TYP	MAX	UNITS
<b>Input Characteristics</b>							
Input Offset Voltage	$V_{OS}$		+25°C		8	35	$\mu\text{V}$
			Full			40	
Input Offset Voltage Drift	$\Delta V_{OS}/\Delta T$		Full		55		$\text{nV}/^\circ\text{C}$
Input Bias Current	$I_B$		+25°C		60	500	$\text{pA}$
Input Offset Current	$I_{OS}$		+25°C		110	700	$\text{pA}$
Input Common Mode Voltage Range	$V_{CM}$		Full	$(-V_S) - 0.1$		$(+V_S) + 0.1$	V
Common Mode Rejection Ratio	CMRR	$(-V_S) - 0.1\text{V} < V_{CM} < (+V_S) + 0.1\text{V}$	+25°C	93	108		dB
			Full	90			
Open-Loop Voltage Gain	$A_{OL}$	$(-V_S) + 0.1\text{V} < V_{OUT} < (+V_S) - 0.1\text{V}$ , $R_L = 10\text{k}\Omega$	+25°C	106	125		dB
			Full	103			
<b>Output Characteristics</b>							
Output Voltage Swing from Rail		$R_L = 10\text{k}\Omega$	+25°C		5.5	10	mV
			Full			11	
Output Short-Circuit Current	$I_{SC}$	$V_S = 1.8\text{V}$	+25°C	5.5	8		mA
		$V_S = 5.5\text{V}$	+25°C	17	26		
<b>Power Supply</b>							
Specified Voltage Range	$V_S$		Full	1.8		5.5	V
Power Supply Rejection Ratio	PSRR	$V_S = 1.8\text{V}$ to $5.5\text{V}$	+25°C		1.8	10	$\mu\text{V}/\text{V}$
			Full			14	
Quiescent Current/Amplifier	$I_Q$	$I_{OUT} = 0$	+25°C		9	13	$\mu\text{A}$
			Full			15.5	
<b>Dynamic Performance</b>							
Gain-Bandwidth Product	GBP	$C_L = 100\text{pF}$	+25°C		110		$\text{kHz}$
Phase Margin	$\phi_o$	$C_L = 100\text{pF}$	+25°C		80		$^\circ$
Slew Rate	SR	$G = 1$	+25°C		0.04		$\text{V}/\mu\text{s}$
Overload Recovery Time		$G = -10$	+25°C		16		$\mu\text{s}$
<b>Noise</b>							
Input Voltage Noise		$f = 0.1\text{Hz}$ to $10\text{Hz}$	+25°C		1		$\mu\text{V}_{P-P}$
Input Voltage Noise Density	$e_n$	$f = 1\text{kHz}$	+25°C		65		$\text{nV}/\sqrt{\text{Hz}}$
Input Current Noise Density	$i_n$	$f = 1\text{kHz}$	+25°C		360		$\text{fA}/\sqrt{\text{Hz}}$

**TYPICAL PERFORMANCE CHARACTERISTICS**

At  $T_A = +25^\circ\text{C}$ ,  $V_S = 5\text{V}$ ,  $R_L = 10\text{k}\Omega$  and  $C_L = 100\text{pF}$ , unless otherwise noted.

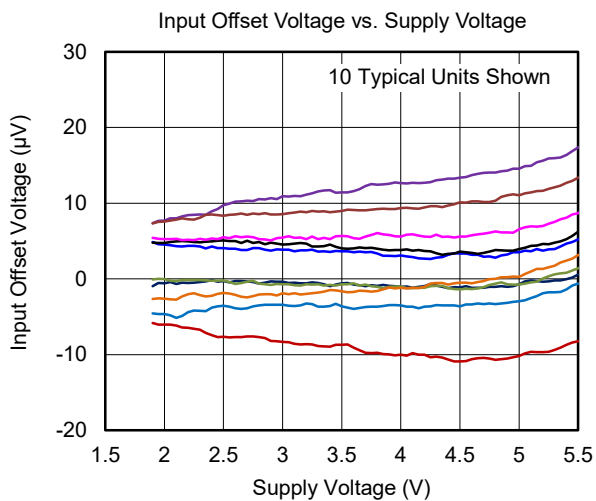
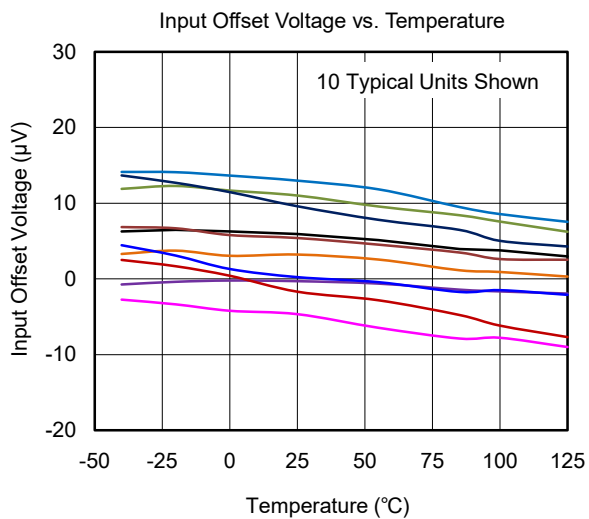
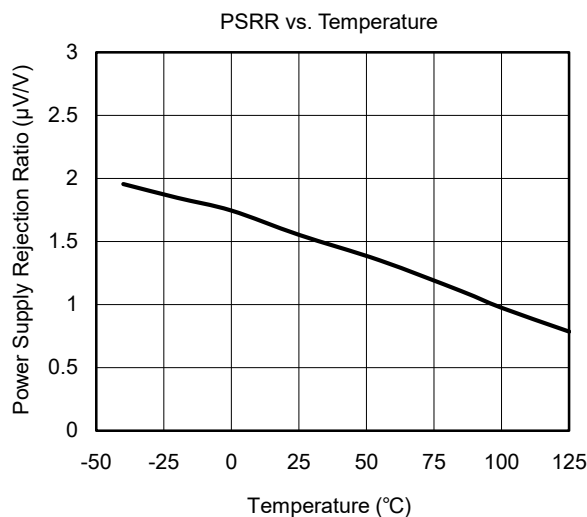
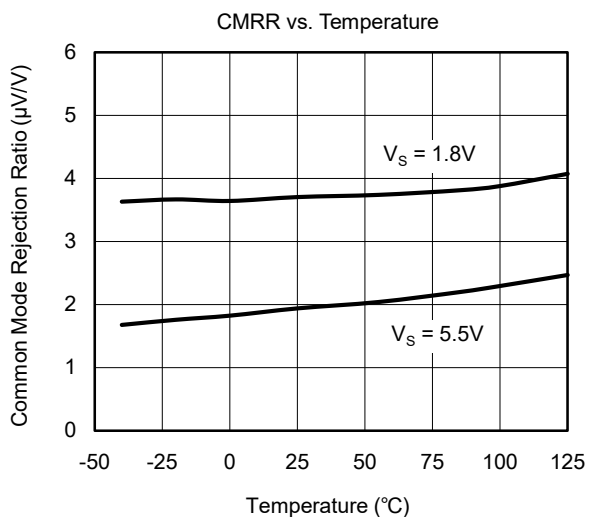
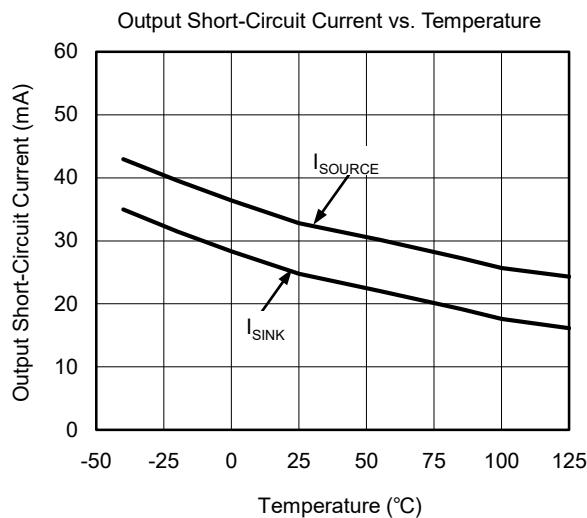
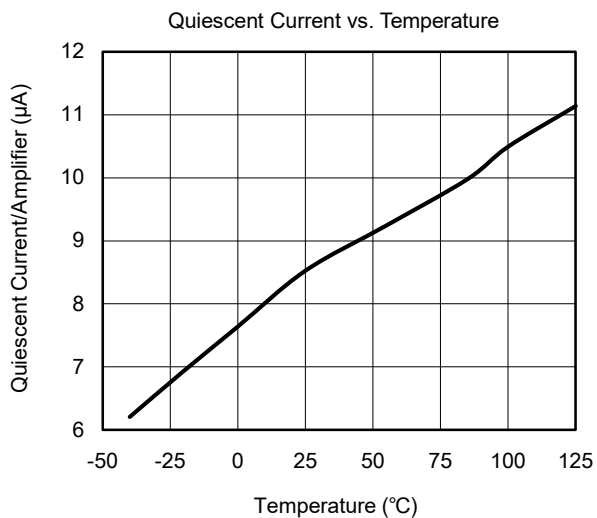

**TYPICAL PERFORMANCE CHARACTERISTICS (continued)**

At  $T_A = +25^\circ\text{C}$ ,  $V_S = 5\text{V}$ ,  $R_L = 10\text{k}\Omega$  and  $C_L = 100\text{pF}$ , unless otherwise noted.

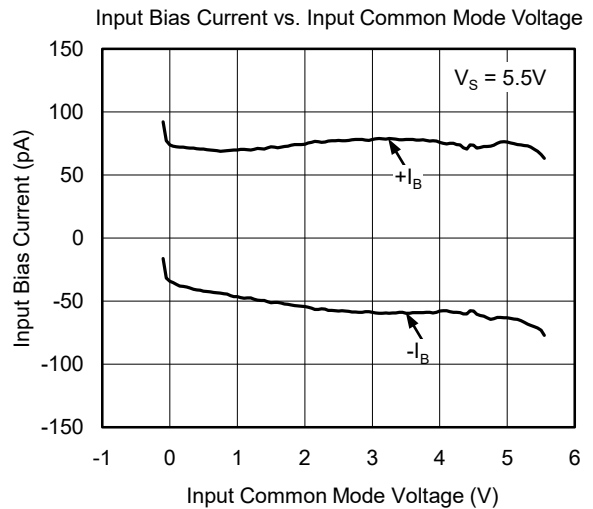
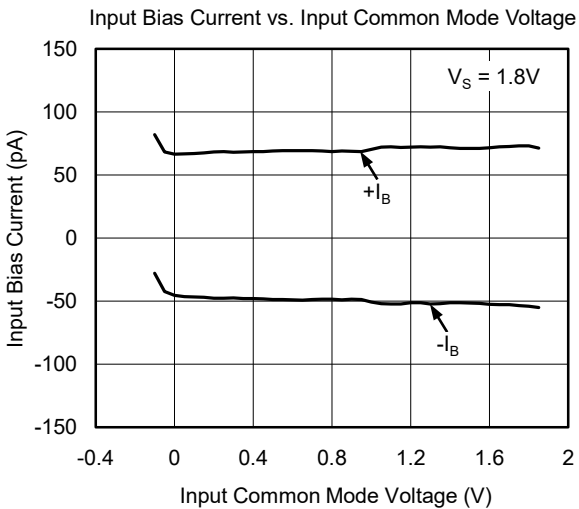
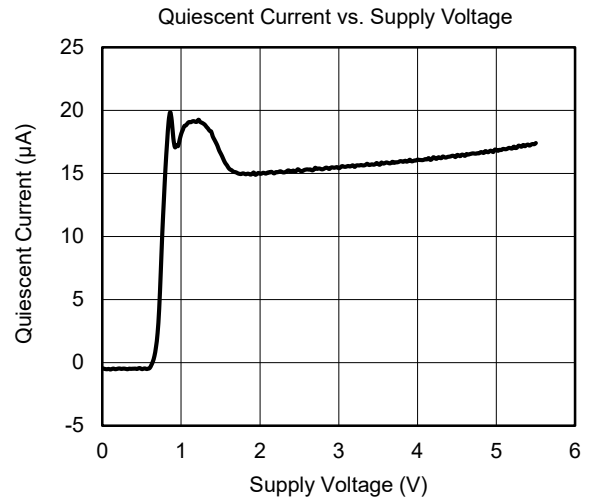
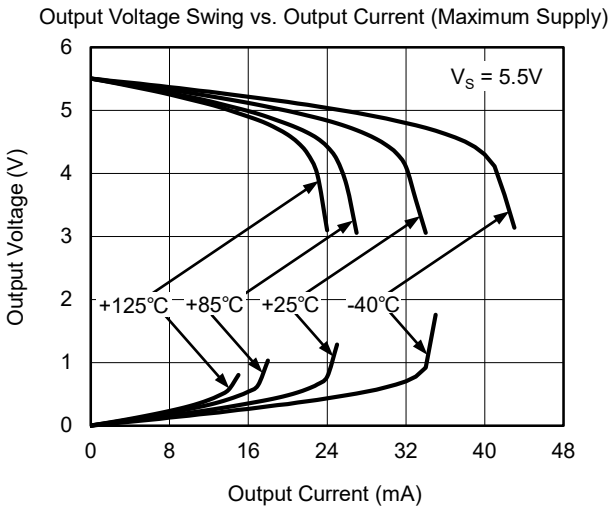
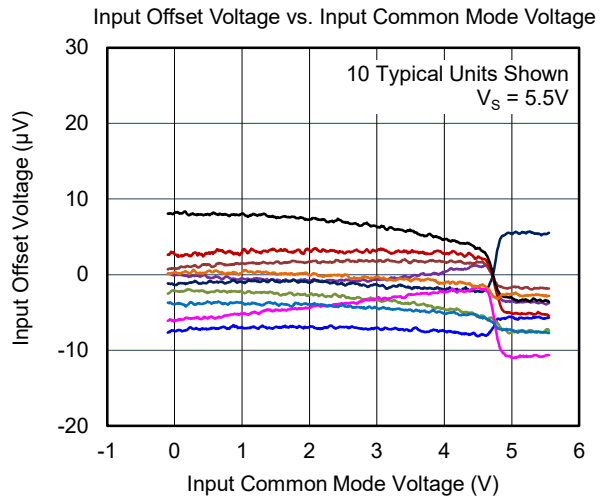
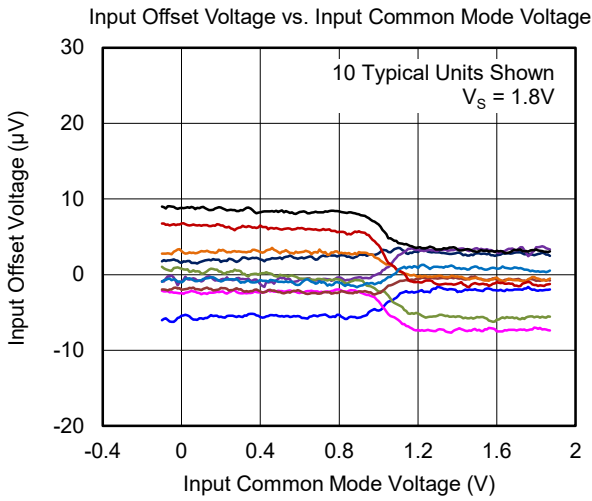

**TYPICAL PERFORMANCE CHARACTERISTICS (continued)**

At  $T_A = +25^\circ\text{C}$ ,  $V_S = 5\text{V}$ ,  $R_L = 10\text{k}\Omega$  and  $C_L = 100\text{pF}$ , unless otherwise noted.

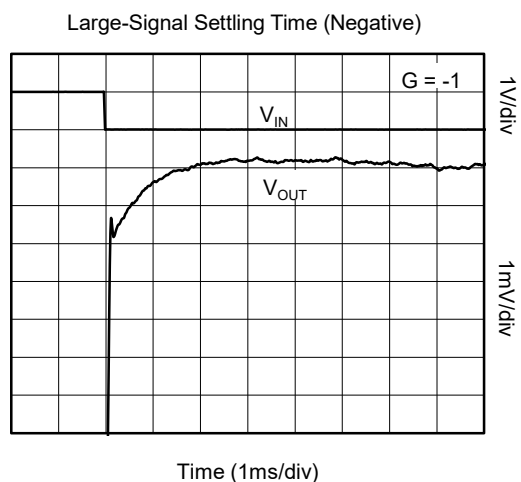
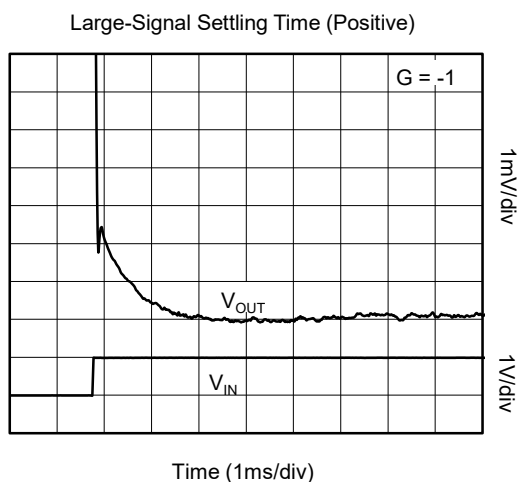
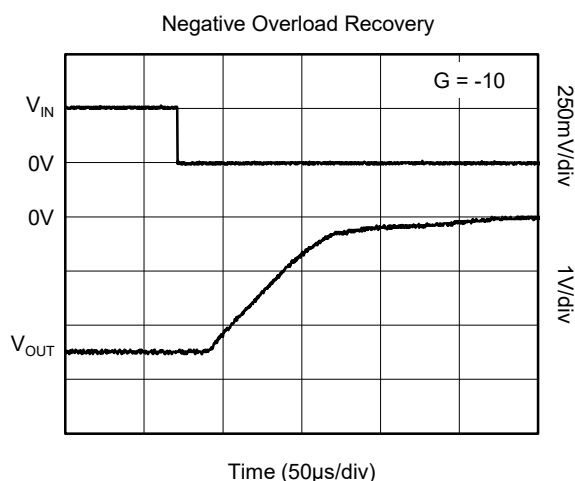
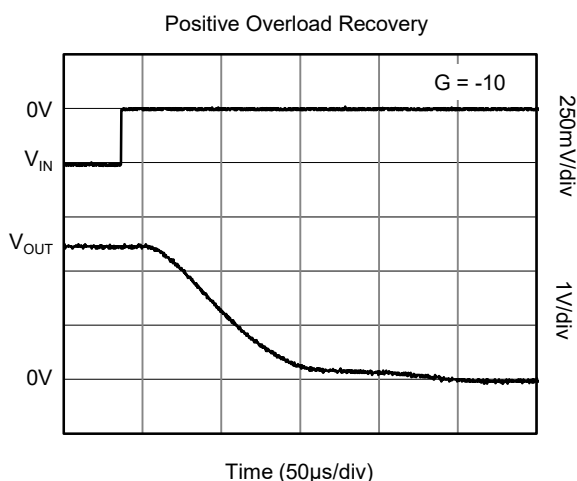
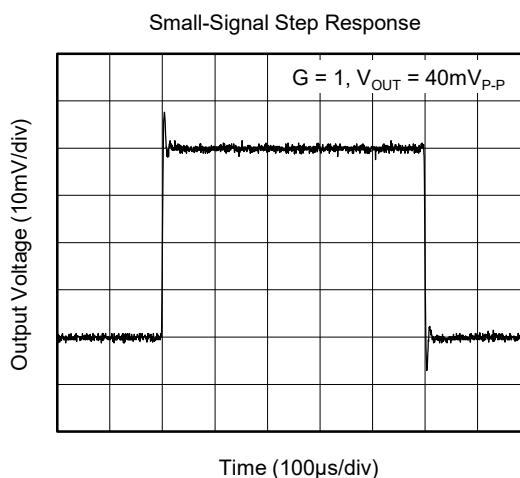
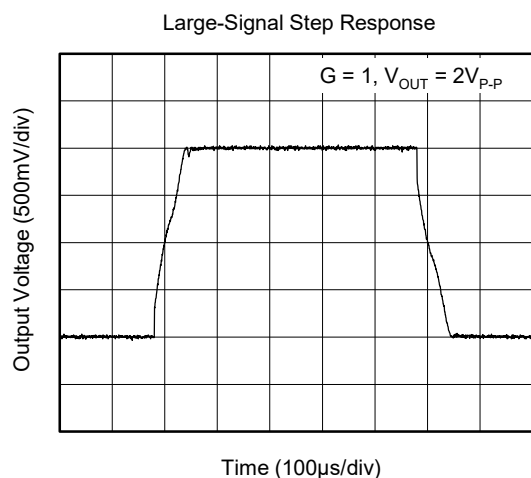

**TYPICAL PERFORMANCE CHARACTERISTICS (continued)**

At  $T_A = +25^\circ\text{C}$ ,  $V_S = 5\text{V}$ ,  $R_L = 10\text{k}\Omega$  and  $C_L = 100\text{pF}$ , unless otherwise noted.

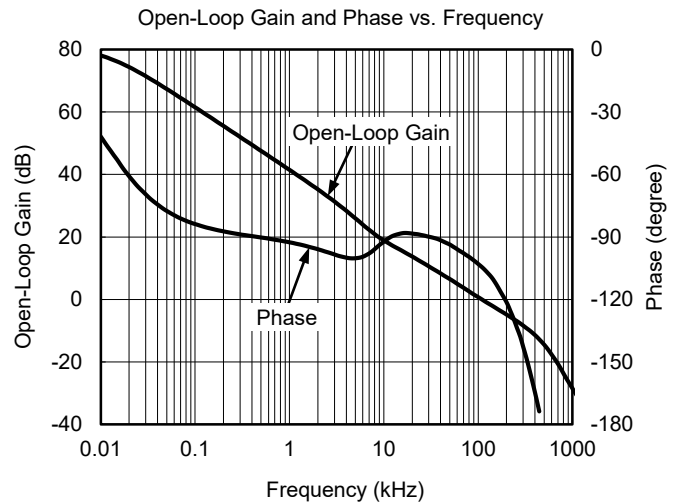
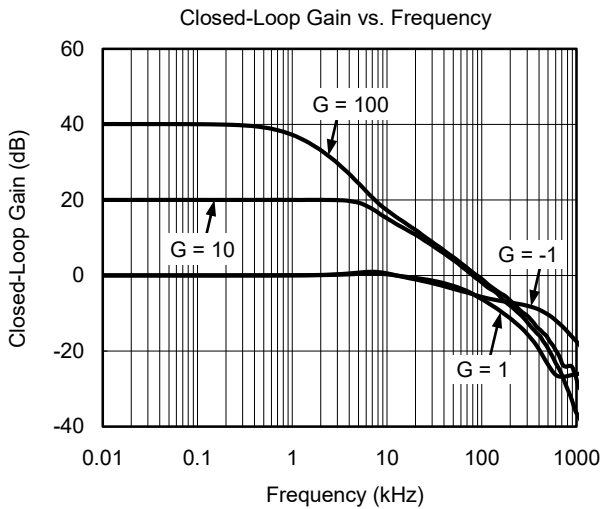
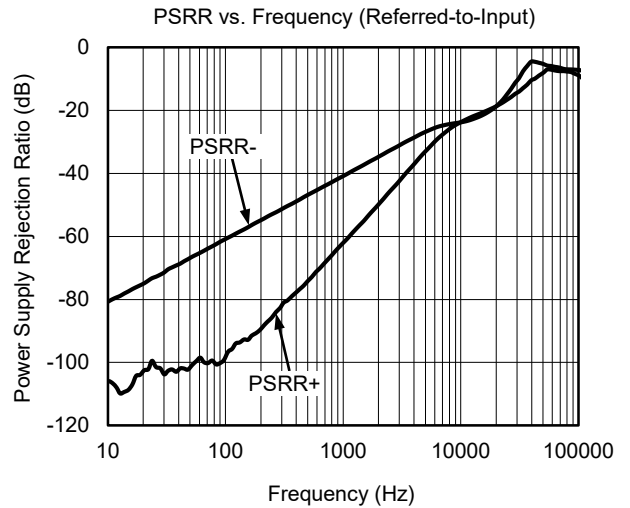
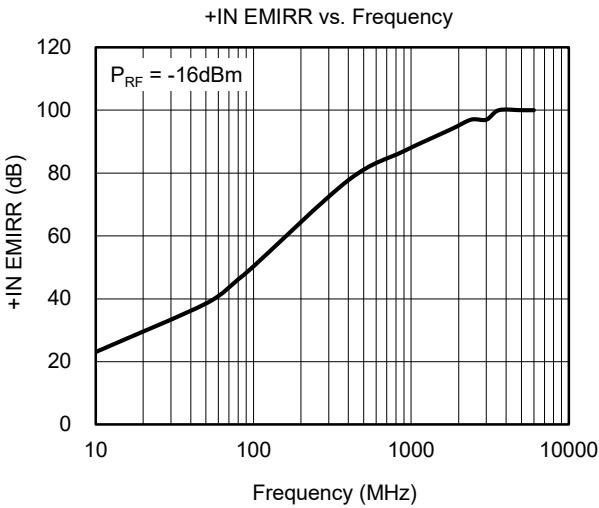
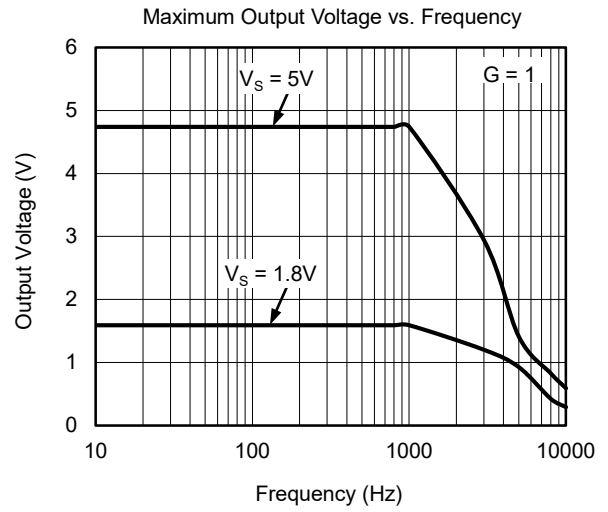
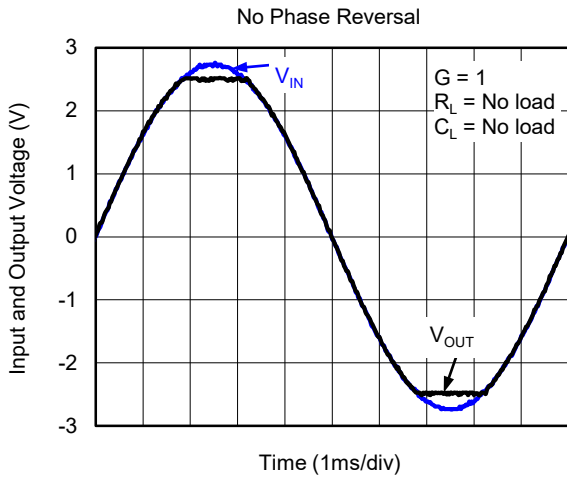



**TYPICAL PERFORMANCE CHARACTERISTICS (continued)**

At  $T_A = +25^\circ\text{C}$ ,  $V_S = 5\text{V}$ ,  $R_L = 10\text{k}\Omega$  and  $C_L = 100\text{pF}$ , unless otherwise noted.

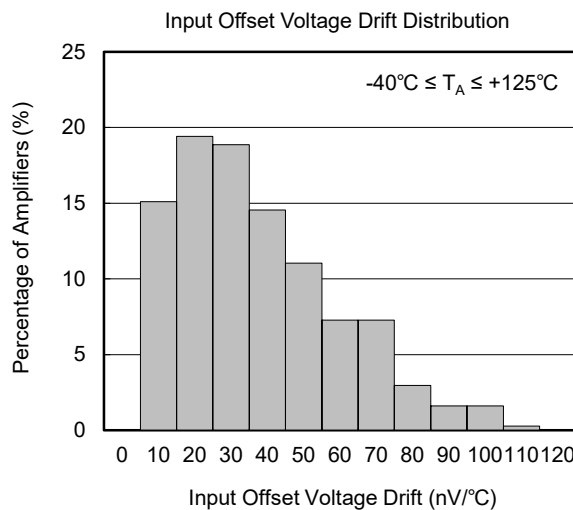
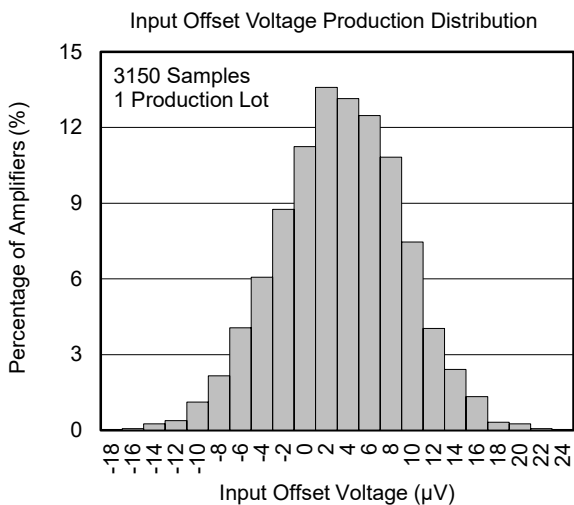
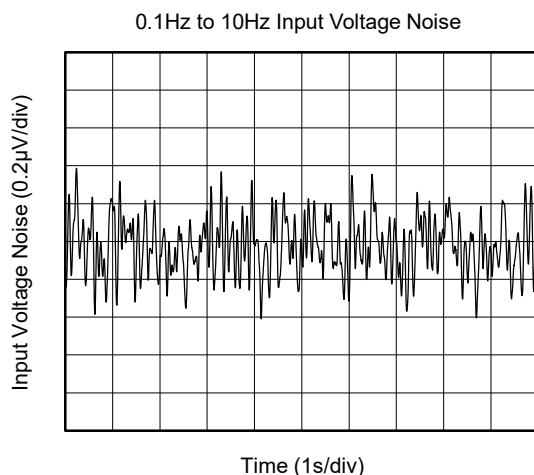
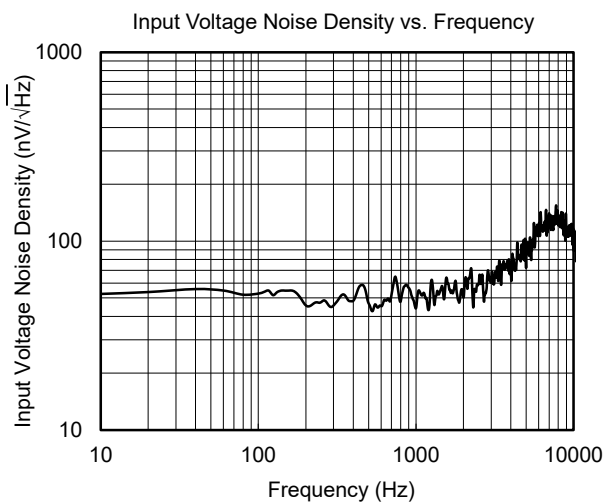
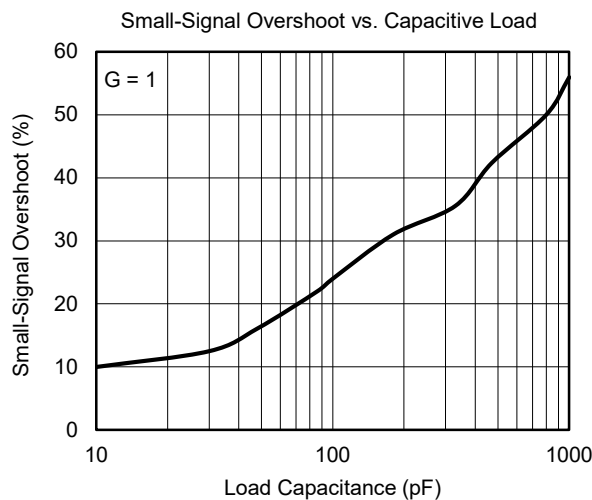
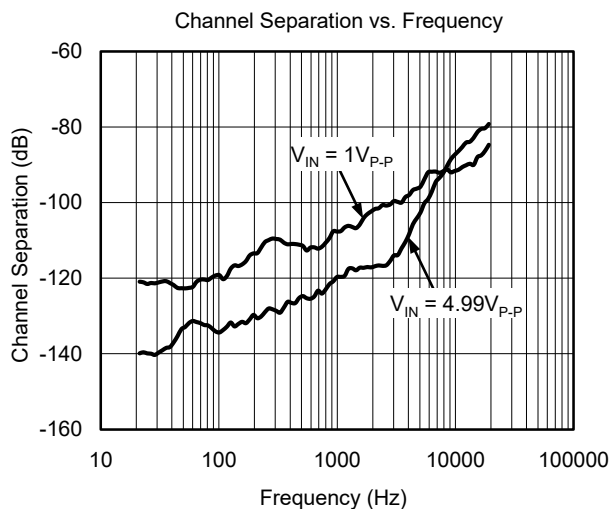

## **REVISION HISTORY**

NOTE: Page numbers for previous revisions may differ from page numbers in the current version.

### **Changes from Original (DECEMBER 2018) to REV.A**

**Page**

---

Changed from product preview to production data.....	All
--	-----

---

# PACKAGE INFORMATION

## PACKAGE OUTLINE DIMENSIONS

### SOT-23-5

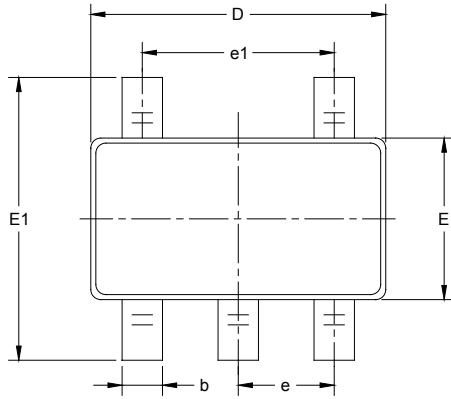

RECOMMENDED LAND PATTERN (Unit: mm)

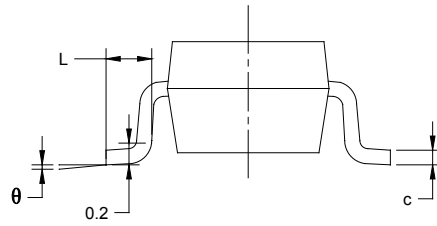
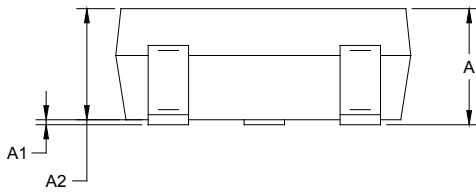

Symbol	Dimensions In Millimeters		Dimensions In Inches	
	MIN	MAX	MIN	MAX
A	1.050	1.250	0.041	0.049
A1	0.000	0.100	0.000	0.004
A2	1.050	1.150	0.041	0.045
b	0.300	0.500	0.012	0.020
c	0.100	0.200	0.004	0.008
D	2.820	3.020	0.111	0.119
E	1.500	1.700	0.059	0.067
E1	2.650	2.950	0.104	0.116
e	0.950 BSC		0.037 BSC	
e1	1.900 BSC		0.075 BSC	
L	0.300	0.600	0.012	0.024
$\theta$	0°	8°	0°	8°

PACKAGE OUTLINE DIMENSIONS

UTDFN-1.6×1.6-6L

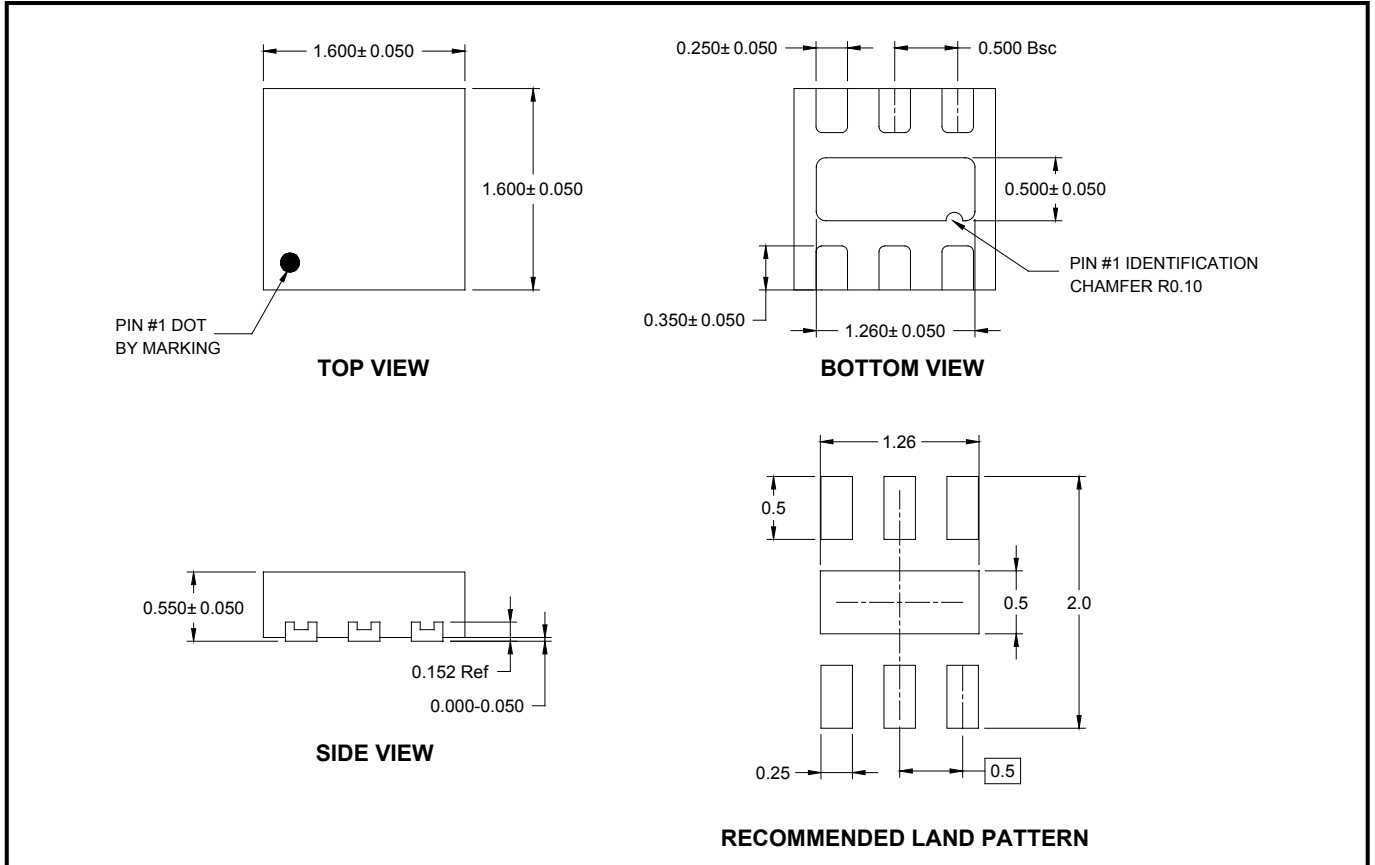

NOTE: All linear dimensions are in millimeters.

PACKAGE OUTLINE DIMENSIONS

TDFN-2x2-8L

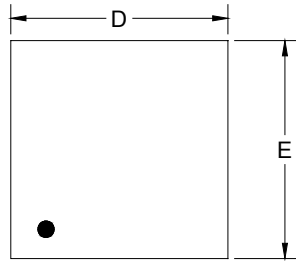

TOP VIEW

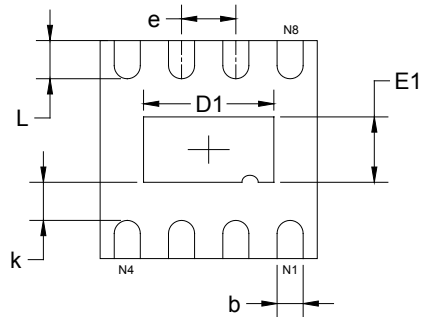

BOTTOM VIEW

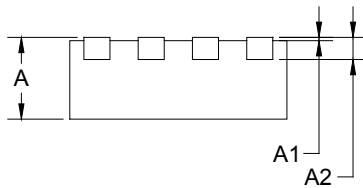

SIDE VIEW

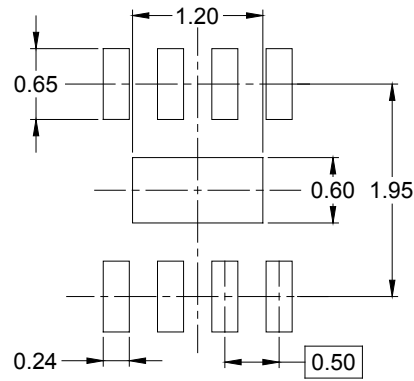

RECOMMENDED LAND PATTERN (Unit: mm)

Symbol	Dimensions In Millimeters		Dimensions In Inches	
	MIN	MAX	MIN	MAX
A	0.700	0.800	0.028	0.031
A1	0.000	0.050	0.000	0.002
A2	0.203 REF		0.008 REF	
D	1.900	2.100	0.075	0.083
D1	1.100	1.300	0.043	0.051
E	1.900	2.100	0.075	0.083
E1	0.500	0.700	0.020	0.028
k	0.200 MIN		0.008 MIN	
b	0.180	0.300	0.007	0.012
e	0.500 TYP		0.020 TYP	
L	0.250	0.450	0.010	0.018

PACKAGE OUTLINE DIMENSIONS

MSOP-8

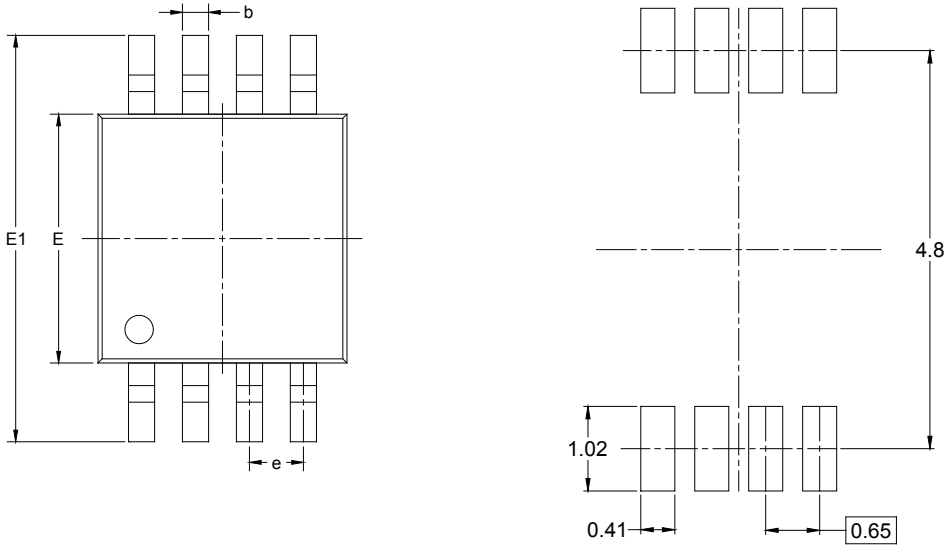

RECOMMENDED LAND PATTERN (Unit: mm)

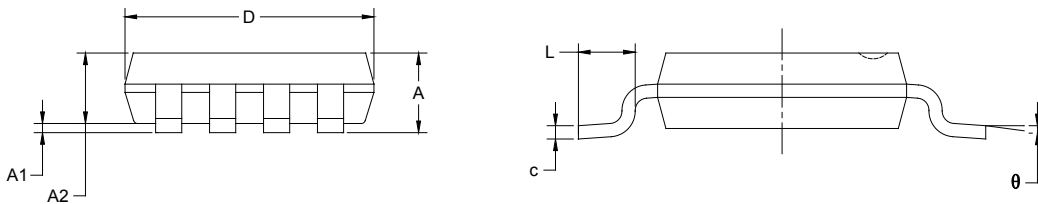

Symbol	Dimensions In Millimeters		Dimensions In Inches	
	MIN	MAX	MIN	MAX
A	0.820	1.100	0.032	0.043
A1	0.020	0.150	0.001	0.006
A2	0.750	0.950	0.030	0.037
b	0.250	0.380	0.010	0.015
c	0.090	0.230	0.004	0.009
D	2.900	3.100	0.114	0.122
E	2.900	3.100	0.114	0.122
E1	4.750	5.050	0.187	0.199
e	0.650 BSC		0.026 BSC	
L	0.400	0.800	0.016	0.031
θ	0°	6°	0°	6°

PACKAGE OUTLINE DIMENSIONS

SOIC-8

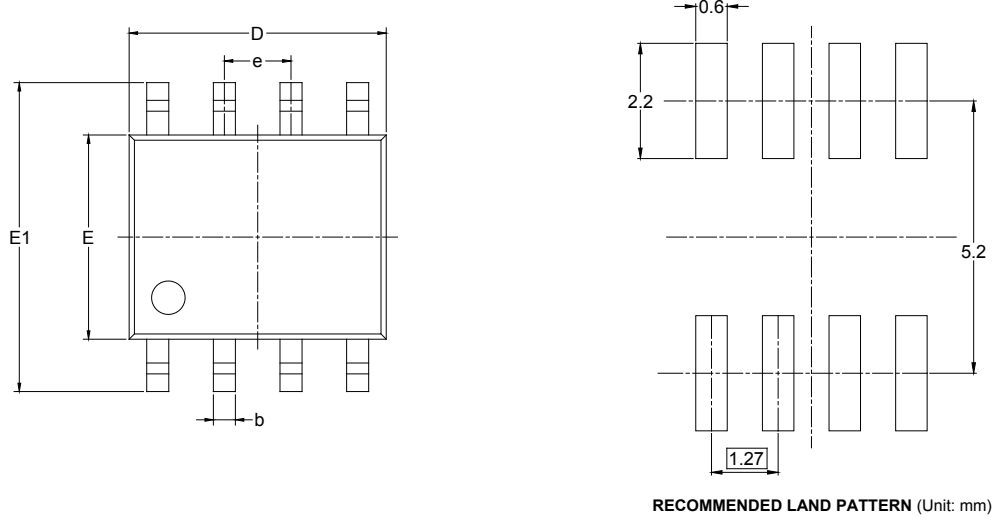

Symbol	Dimensions In Millimeters		Dimensions In Inches	
	MIN	MAX	MIN	MAX
A	1.350	1.750	0.053	0.069
A1	0.100	0.250	0.004	0.010
A2	1.350	1.550	0.053	0.061
b	0.330	0.510	0.013	0.020
c	0.170	0.250	0.006	0.010
D	4.700	5.100	0.185	0.200
E	3.800	4.000	0.150	0.157
E1	5.800	6.200	0.228	0.244
e	1.27 BSC		0.050 BSC	
L	0.400	1.270	0.016	0.050
$\theta$	0°	8°	0°	8°

# PACKAGE INFORMATION

## TAPE AND REEL INFORMATION

### REEL DIMENSIONS



### TAPE DIMENSIONS



NOTE: The picture is only for reference. Please make the object as the standard.

### KEY PARAMETER LIST OF TAPE AND REEL

Package Type	Reel Diameter	Reel Width W1 (mm)	A0 (mm)	B0 (mm)	K0 (mm)	P0 (mm)	P1 (mm)	P2 (mm)	W (mm)	Pin1 Quadrant
SOT-23-5	7"	9.5	3.20	3.20	1.40	4.0	4.0	2.0	8.0	Q3
UTDFN-1.6×1.6-6L	7"	9.0	1.78	1.78	0.69	4.0	4.0	2.0	8.0	Q1
TDFN-2×2-8L	7"	9.5	2.30	2.30	1.10	4.0	4.0	2.0	8.0	Q1
MSOP-8	13"	12.4	5.20	3.30	1.50	4.0	8.0	2.0	12.0	Q1
SOIC-8	13"	12.4	6.40	5.40	2.10	4.0	8.0	2.0	12.0	Q1

D20001



# PACKAGE INFORMATION

## CARTON BOX DIMENSIONS



NOTE: The picture is only for reference. Please make the object as the standard.

## KEY PARAMETER LIST OF CARTON BOX

Reel Type	Length (mm)	Width (mm)	Height (mm)	Pizza/Carton
7" (Option)	368	227	224	8
7"	442	410	224	18
13"	386	280	370	5

DD0002

单击下面可查看定价，库存，交付和生命周期等信息

[>>SGMICRO\(圣邦微电子\)](#)