



SGM4917

80mW, Capless, Stereo Headphone Amplifier with Shutdown

GENERAL DESCRIPTION

The SGM4917 is stereo headphone amplifier which is designed for portable applications and can operate from a 2.7V to 5.5V single supply. Capless design can produce a ground-referenced output from a single power supply, and can eliminate output DC-blocking capacitors for less-component height and low-cost. For SGM4917B, the internal gain setting (-2V/V) is to further reduce component count. For SGM4917A, the gain can be adjusted by external feedback resistors.

The SGM4917 has low quiescent current 2.7mA at 5V supply, low 0.02% THD+N, 80mW per channel into 32Ω load from 5V power supply at THD+N = 0.1%. The high supply rejection ratio (PSRR) of -78dB at 217Hz allows the device to operate from noisy digital supplies without an additional linear regulator. The device provides short-circuit and thermal-overload protections. Build-in shutdown control also helps for pop/click-free on/off control.

The SGM4917 is available in a Green TQFN-3×3-16L package. It operates over an ambient temperature range of -40°C to +85°C.

FEATURES

- **Supply Voltage Range: 2.7V to 5.5V**
- **SGM4917A: External Feedback Gain Network**
SGM4917B: Fixed -2V/V Gain
- **Capless Structure**
 - ◆ **Eliminates Ground-Referenced Outputs**
 - ◆ **Eliminates Output DC-Blocking Capacitors**
 - ◆ **Provides Flat Frequency Response**
- **80mW into 32Ω Load from 5V Power Supply at THD+N = 0.1% (Typical, per Channel)**
- **THD+N = 0.02% (f = 1kHz)**
- **High PSRR: -78dB (at 217Hz)**
- **Quiescent Current: 2.7mA (TYP)**
- **Shutdown Control**
- **Short-Circuit and Thermal-Overload Protections**
- **Under-Voltage Lockout Function**
- **Enhanced Noise Cancellation by Differential Inputs**
- **-40°C to +85°C Operating Temperature Range**
- **Available in a Green TQFN-3×3-16L Package**

APPLICATIONS

Smart Phones
Portable Audio Equipment
Notebook PCs
PDAs

PACKAGE/ORDERING INFORMATION

MODEL	GAIN (V/V)	PACKAGE DESCRIPTION	SPECIFIED TEMPERATURE RANGE	ORDERING NUMBER	PACKAGE MARKING	PACKING OPTION
SGM4917A	ADJ	TQFN-3x3-16L	-40°C to +85°C	SGM4917AYTQ16G/TR	4917AQ XXXXX	Tape and Reel, 3000
SGM4917B	-2	TQFN-3x3-16L	-40°C to +85°C	SGM4917BYTQ16G/TR	4917BQ XXXXX	Tape and Reel, 3000

MARKING INFORMATION

NOTE: XXXXX = Date Code and Vendor Code.

XXXXX

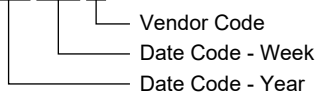

Green (RoHS & HSF): SG Micro Corp defines "Green" to mean Pb-Free (RoHS compatible) and free of halogen substances. If you have additional comments or questions, please contact your SGMICRO representative directly.

ABSOLUTE MAXIMUM RATINGS

PV _{SS} to SV _{SS}	-0.3V to +0.3V
PGND to SGND	-0.3V to +0.3V
PV _{DD} to SV _{DD}	-0.3V to +0.3V
PV _{DD} and SV _{DD} to PGND or SGND	-0.3V to +6V
PV _{SS} and SV _{SS} to PGND or SGND	-6V to +0.3V
IN to SGND	(SV _{SS} - 0.3V) to (SV _{DD} + 0.3V)
SHDN to SGND	-0.3V to (SV _{DD} + 0.3V)
OUT to SGND	(SV _{SS} - 0.3V) to (SV _{DD} + 0.3V)
C1P to PGND	-0.3V to (PV _{DD} + 0.3V)
C1N to PGND	(PV _{SS} - 0.3V) to + 0.3V
Output Short Circuit to GND or V _{DD}	Continuous
Junction Temperature	+150°C
Storage Temperature Range	-65°C to +150°C
Lead Temperature (Soldering, 10s)	+260°C
ESD Susceptibility	
HBM.....	2000V
HBM (Output pins to Supply and Ground pins).....	4000V
MM.....	150V

RECOMMENDED OPERATING CONDITIONS

Supply Voltage Range	2.7V to 5.5V
Operating Temperature Range	-40°C to +85°C

OVERSTRESS CAUTION

Stresses beyond those listed in Absolute Maximum Ratings may cause permanent damage to the device. Exposure to absolute maximum rating conditions for extended periods may affect reliability. Functional operation of the device at any conditions beyond those indicated in the Recommended Operating Conditions section is not implied.

ESD SENSITIVITY CAUTION

This integrated circuit can be damaged if ESD protections are not considered carefully. SGMICRO recommends that all integrated circuits be handled with appropriate precautions. Failure to observe proper handling and installation procedures can cause damage. ESD damage can range from subtle performance degradation to complete device failure. Precision integrated circuits may be more susceptible to damage because even small parametric changes could cause the device not to meet the published specifications.

DISCLAIMER

SG Micro Corp reserves the right to make any change in circuit design, or specifications without prior notice.

PIN CONFIGURATION

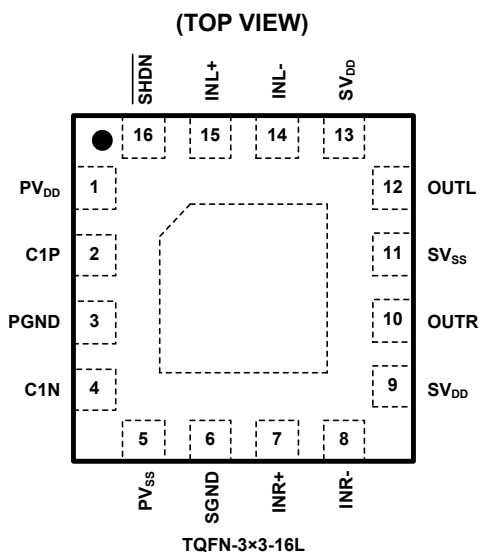

PIN DESCRIPTION

PIN	NAME	DESCRIPTION
1	PV _{DD}	Charge-Pump Power Supply. Powers charge-pump inverter, charge-pump logic, and oscillator. Connect to positive supply (2.7V to 5.5V). Bypass with a 1 μ F capacitor to PGND as close to the pin as possible.
2	C1P	Positive Terminal for Flying Capacitor. Connect a 1 μ F capacitor to C1N.
3	PGND	Power Ground. Connect to ground.
4	C1N	Negative Terminal for Flying Capacitor. Connect a 1 μ F capacitor to C1P.
5	PV _{SS}	Charge-Pump Output. Connect to SV _{SS} .
6	SGND	Signal Ground. Connect to ground.
7	INR+	Noninverting Right-Channel Audio Input.
8	INR-	Inverting Right-Channel Audio Input.
9,13	SV _{DD}	Amplifier Positive Power Supply. Connect to positive supply (2.7V to 5.5V). Bypass with a 1 μ F capacitor to SGND as close to the pin as possible.
10	OUTR	Output for Right-Channel.
11	SV _{SS}	Amplifier Negative Power Supply. Connect to PV _{SS} .
12	OUTL	Output for Left-Channel.
14	INL-	Inverting Left-Channel Audio Input.
15	INL+	Noninverting Left-Channel Audio Input.
16	SHDN	Active-Low Shutdown Input.
Exposed Pad	—	Exposed Pad. Can be connected to GND or left floating.

ELECTRICAL CHARACTERISTICS

($P_{V_{DD}} = S_{V_{DD}} = 5V$, $P_{GND} = S_{GND} = 0V$, $\overline{SHDN} = S_{V_{DD}}$, $C1 = C2 = 1\mu F$, $R_L = \infty$, resistive load referenced to ground; for SGM4917A, gain = $-1V/V$ ($R_{IN} = R_F = 10k\Omega$); for SGM4917B, gain = $-2V/V$ (internally set). $T_A = +25^\circ C$, unless otherwise noted.)

PARAMETER	SYMBOL	CONDITIONS	MIN	TYP	MAX	UNITS
General						
Supply Voltage Range	V_{DD}		2.7		5.5	V
Quiescent Supply Current	I_{DD}			2.7	3.7	mA
Shutdown Supply Current	I_{SHDN}	$\overline{SHDN} = S_{GND} = P_{GND}$		0.01	8	μA
\overline{SHDN} Input Logic High	V_{IH}		1.2			V
\overline{SHDN} Input Logic Low	V_{IL}				0.4	V
\overline{SHDN} to Full Operation Time	t_{SON}			3.2		ms
Amplifiers						
Voltage Gain	A_V	SGM4917B	-2.12	-2	-1.88	V/V
Gain Matching	ΔA_V	SGM4917B, between the right and left channels		0.2		%
Output Offset Voltage	V_{OS}	Between IN+ and IN-, input AC-coupled to ground (SGM4917A)	-5.5	1.1	5.5	mV
Input Impedance	R_{IN}	SGM4917B, measured at INL and INR	12.5	14.6	17	k Ω
Common Mode Rejection Ratio	CMRR	Input referred, SGM4917A		-70		dB
Power Supply Rejection Ratio	PSRR	$f = 217Hz$, $V_{RIPPLE} = 200mV_{P-P}$		-78		dB
		$f = 10kHz$, $V_{RIPPLE} = 200mV_{P-P}$		-70		
Output Power	P_{OUT}	$R_L = 32\Omega$, THD+N = 0.1%		80		mW
Output Impedance in Shutdown				2		k Ω
Total Harmonic Distortion Plus Noise	THD+N	$R_L = 32\Omega$, $P_{OUT} = 55mW$, $f = 1kHz$		0.02		%
Signal-to-Noise Ratio	SNR	$R_L = 32\Omega$, $P_{OUT} = 20mW$, BW < 20kHz		100		dB
Capacitive Drive	C_L	No sustained oscillation		200		pF
Charge-Pump Oscillator Frequency	f_{OSC}		200	350	500	kHz
Crosstalk		$R_L = 32\Omega$, $V_{IN} = 200mV_{P-P}$, $f = 10kHz$ $A_V = -1V/V$		90		dB
Thermal Shutdown Threshold				137		$^\circ C$
Thermal Shutdown Hysteresis				11		$^\circ C$

TYPICAL PERFORMANCE CHARACTERISTICS

THD+N vs. Output Power

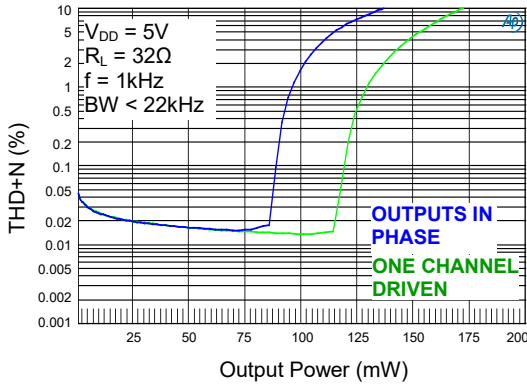

THD+N vs. Output Power

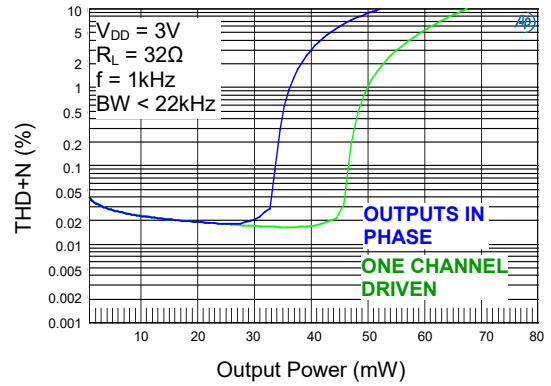

Power Dissipation vs. Output Power

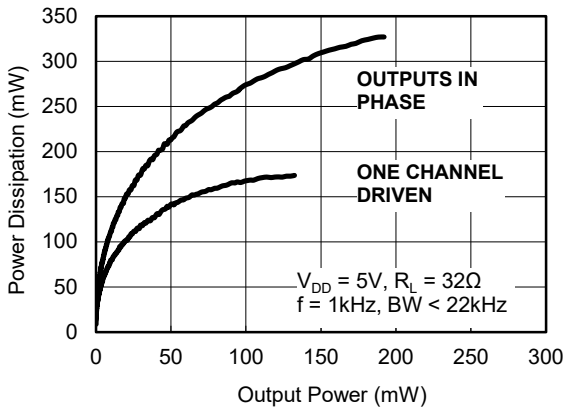

Power Dissipation vs. Output Power

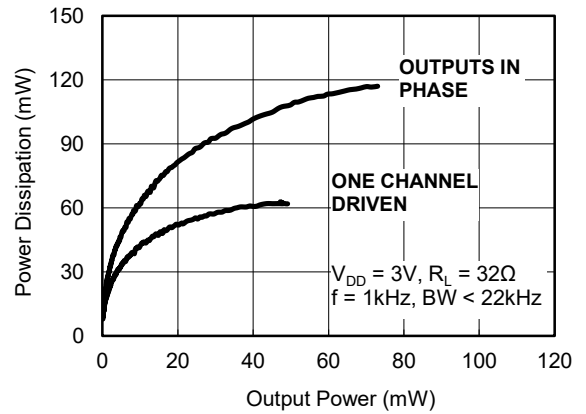

Output Power vs. Supply Voltage

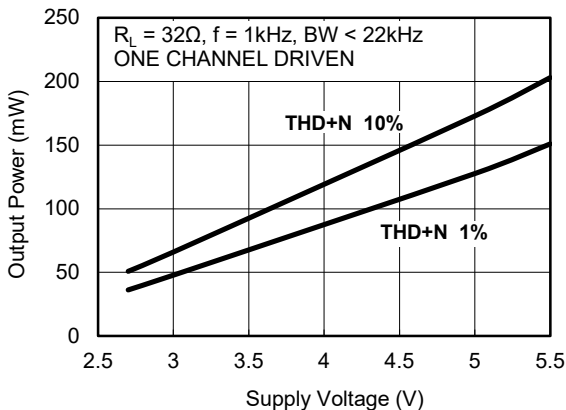

Output Power vs. Supply Voltage

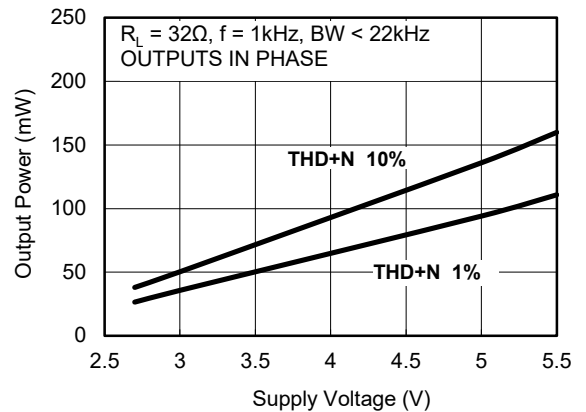

TYPICAL PERFORMANCE CHARACTERISTICS (continued)

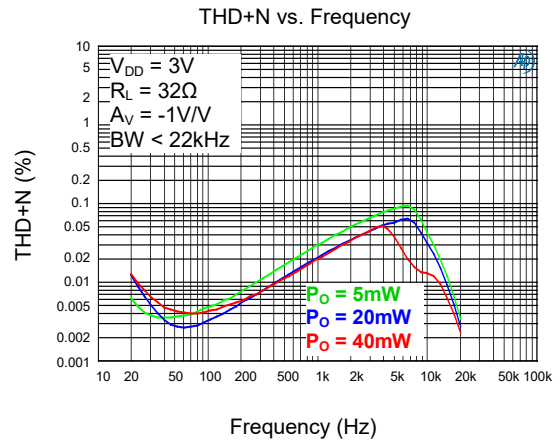
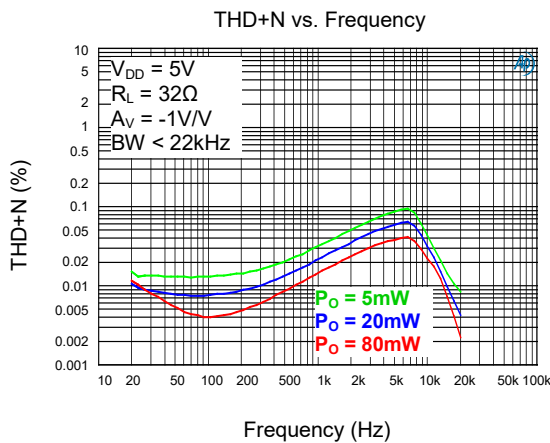
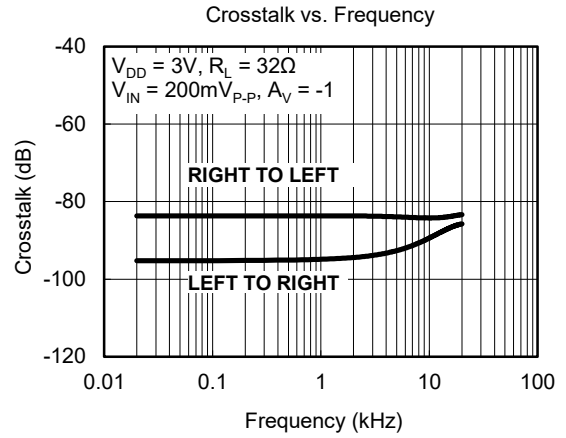
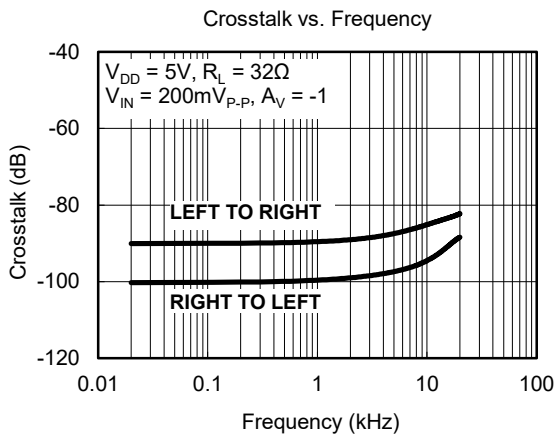
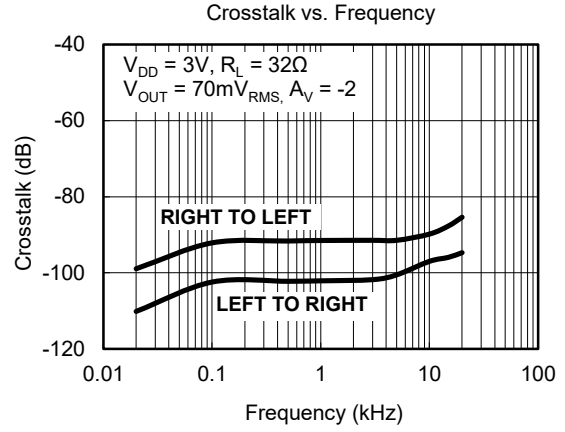
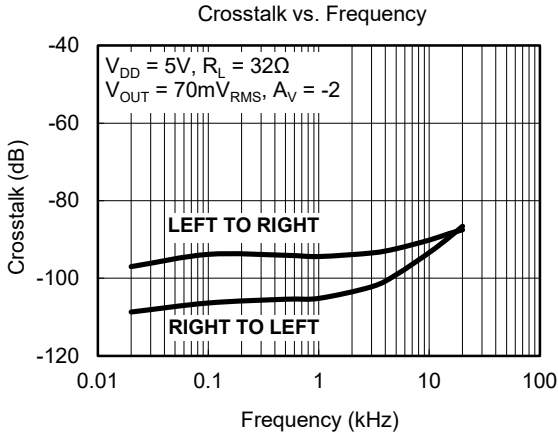

TYPICAL PERFORMANCE CHARACTERISTICS (continued)

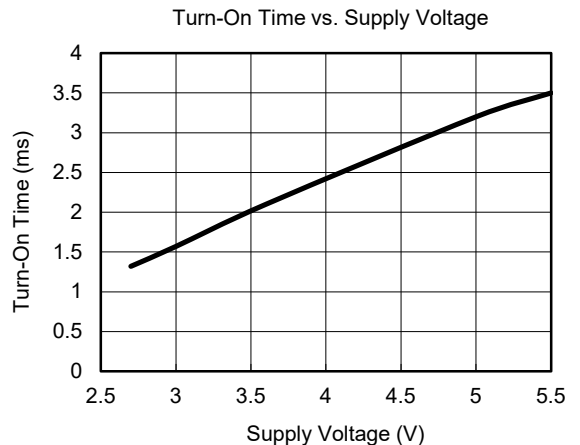
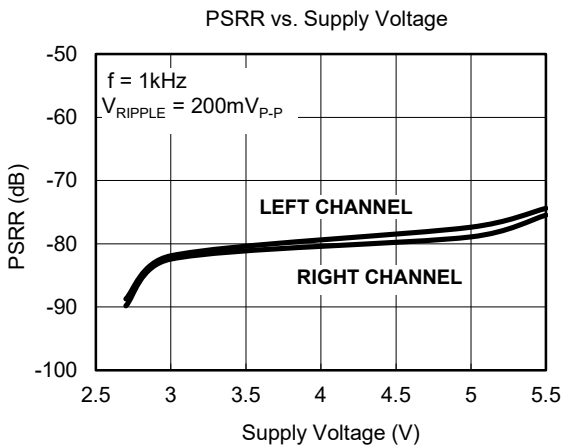
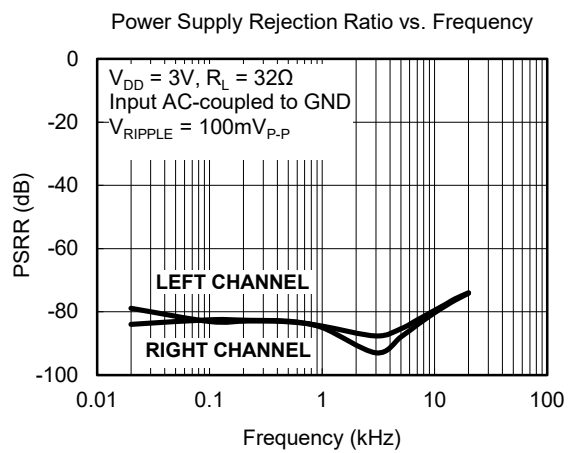
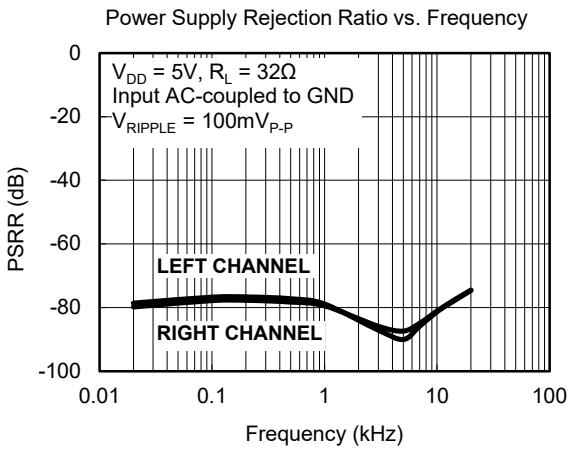
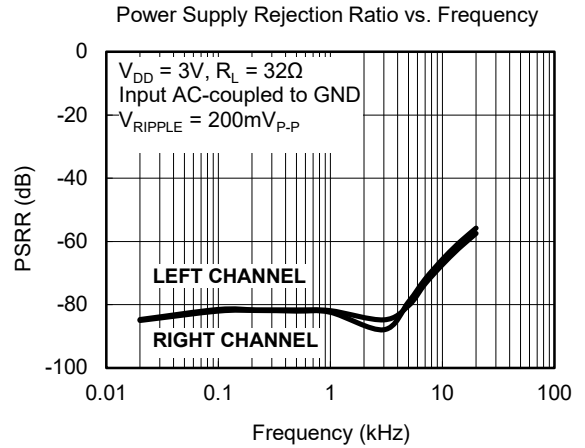
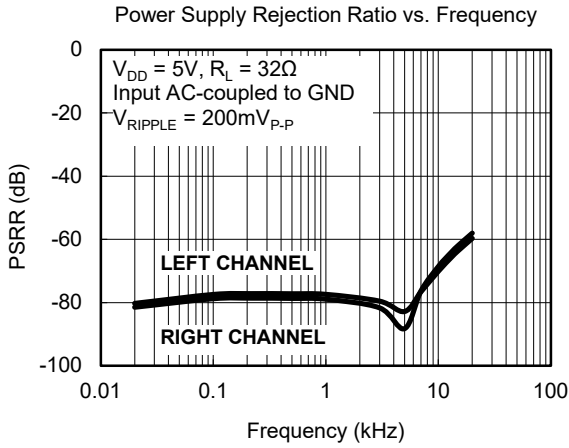

REVISION HISTORY

NOTE: Page numbers for previous revisions may differ from page numbers in the current version.

JULY 2017 – REV.A.2 to REV.A.3

Updated Typical Application Circuit 8-9

DECEMBER 2012 – REV.A.1 to REV.A.2

Added note for Typical Application Circuit..... 8-9

SEPTEMBER 2012 – REV.A to REV.A.1

Added Tape and Reel Information 11-12

Changes from Original (FEBRUARY 2012) to REV.A

Changed from product preview to production data..... All

PACKAGE INFORMATION

PACKAGE OUTLINE DIMENSIONS

TQFN-3×3-16L

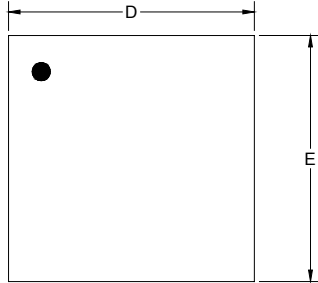

TOP VIEW

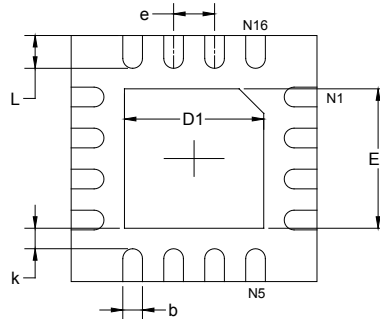

BOTTOM VIEW

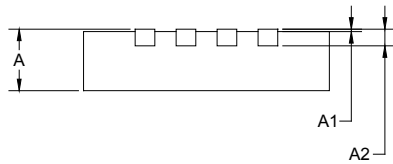

SIDE VIEW

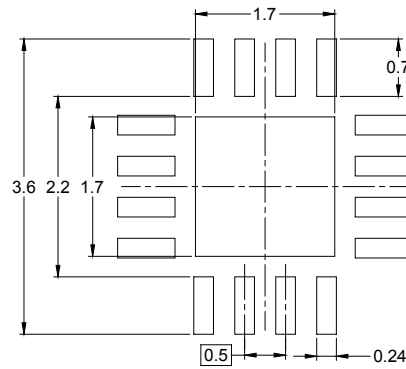

RECOMMENDED LAND PATTERN (Unit: mm)

Symbol	Dimensions In Millimeters		Dimensions In Inches	
	MIN	MAX	MIN	MAX
A	0.700	0.800	0.028	0.031
A1	0.000	0.050	0.000	0.002
A2	0.203 REF		0.008 REF	
D	2.900	3.100	0.114	0.122
D1	1.600	1.800	0.063	0.071
E	2.900	3.100	0.114	0.122
E1	1.600	1.800	0.063	0.071
k	0.200 MIN		0.008 MIN	
b	0.180	0.300	0.007	0.012
e	0.500 TYP		0.020 TYP	
L	0.300	0.500	0.012	0.020

PACKAGE INFORMATION

TAPE AND REEL INFORMATION

REEL DIMENSIONS

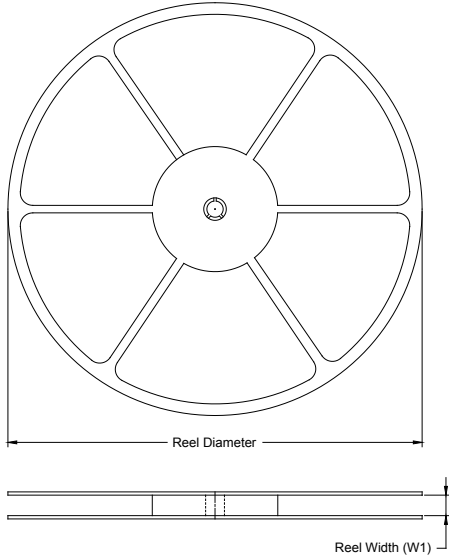

TAPE DIMENSIONS

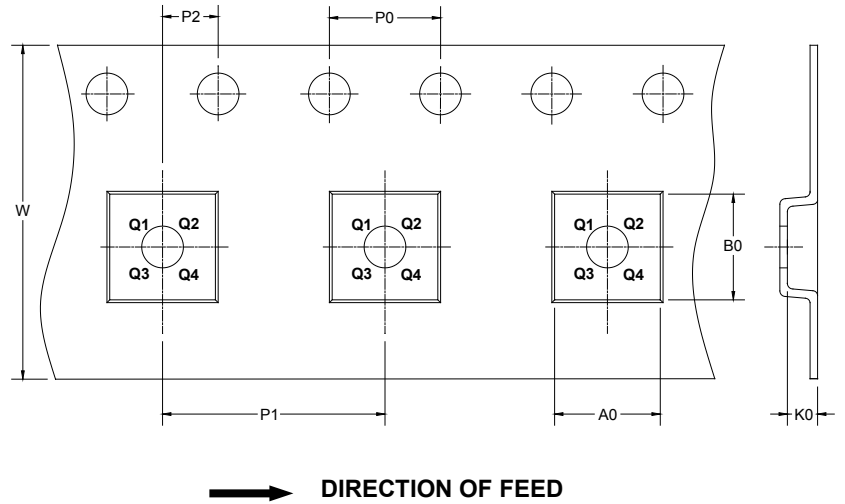

NOTE: The picture is only for reference. Please make the object as the standard.

KEY PARAMETER LIST OF TAPE AND REEL

Package Type	Reel Diameter	Reel Width W1 (mm)	A0 (mm)	B0 (mm)	K0 (mm)	P0 (mm)	P1 (mm)	P2 (mm)	W (mm)	Pin1 Quadrant
TQFN-3×3-16L	13"	12.4	3.35	3.35	1.13	4.0	8.0	2.0	12.0	Q1

000001

PACKAGE INFORMATION

CARTON BOX DIMENSIONS



NOTE: The picture is only for reference. Please make the object as the standard.

KEY PARAMETER LIST OF CARTON BOX

Reel Type	Length (mm)	Width (mm)	Height (mm)	Pizza/Carton
13"	386	280	370	5

DD0002

单击下面可查看定价，库存，交付和生命周期等信息

[>>SGMICRO\(圣邦微电子\)](#)