



SGM8748

155ns, Low-Power, 3V/5V, Rail-to-Rail Input Single-Supply Comparator

GENERAL DESCRIPTION

The SGM8748 is a dual, rail-to-rail input, single-supply comparator with typical 45 μ A power supply current. The comparator operates from a wide range of 2.7V to 5.5V supply voltage and features high-speed response, and rail-to-rail input range.

The SGM8748 is optimized for low-power, single-supply operation with greater than rail-to-rail input operation. The output stage pulls to within 0.1V of either supply rail without external pull-up circuitry, and interfaces with CMOS/TTL logic. All input and output pins have a continuous short-circuit protection to each rail.

The SGM8748 is available in Green SOIC-8 and MSOP-8 packages. It is rated over the -40 $^{\circ}$ C to +85 $^{\circ}$ C temperature range.

FEATURES

- **Fast Propagation Delay:**
155ns (TYP) at 10mV Overdrive
- **Low Quiescent Current:**
45 μ A (TYP) at $V_S = 3V$
- **Wide Single-Supply Voltage Range: 2.7V to 5.5V**
- **Optimized for 3V/5V Applications**
- **Rail-to-Rail Input**
- **Low Offset Voltage: 0.8mV (TYP)**
- **Output Swing to within 190mV from Rails with 4mA Output Current**
- **CMOS/TTL-Compatible Output**
- **Internal Hysteresis for Clean Switching**
- **-40 $^{\circ}$ C to +85 $^{\circ}$ C Operating Temperature Range**
- **Available in Green SOIC-8 and MSOP-8 Packages**

APPLICATIONS

Portable and Battery-Powered Applications
3V/5V Applications
Threshold Detectors
Line Receivers

PACKAGE/ORDERING INFORMATION

MODEL	PACKAGE DESCRIPTION	SPECIFIED TEMPERATURE RANGE	ORDERING NUMBER	PACKAGE MARKING	PACKING OPTION
SGM8748	SOIC-8	-40°C to +85°C	SGM8748YS8G/TR	SGM 8748YS8 XXXXX	Tape and Reel, 2500
	MSOP-8	-40°C to +85°C	SGM8748YMS8G/TR	SGM8748 YMS8 XXXXX	Tape and Reel, 4000

MARKING INFORMATION

NOTE: XXXXX = Date Code and Vendor Code.

SOIC-8/MSOP-8

XXXXX

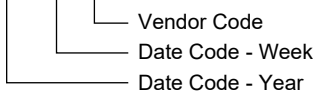

Green (RoHS & HSF): SG Micro Corp defines "Green" to mean Pb-Free (RoHS compatible) and free of halogen substances. If you have additional comments or questions, please contact your SGMICRO representative directly.

ABSOLUTE MAXIMUM RATINGS

Supply Voltage, +V _s to -V _s	6V
V _{IN} Differential	±2.5V
Voltage at Input/Output Pins	(-V _s) - 0.3V to (+V _s) + 0.3V
Junction Temperature	+150°C
Storage Temperature Range	-65°C to +150°C
Lead Temperature (Soldering, 10s)	+260°C
ESD Susceptibility	
HBM	6000V
MM	400V

RECOMMENDED OPERATING CONDITIONS

Operating Temperature Range	-40°C to +85°C
-----------------------------------	----------------

OVERSTRESS CAUTION

Stresses beyond those listed in Absolute Maximum Ratings may cause permanent damage to the device. Exposure to absolute maximum rating conditions for extended periods may affect reliability. Functional operation of the device at any conditions beyond those indicated in the Recommended Operating Conditions section is not implied.

ESD SENSITIVITY CAUTION

This integrated circuit can be damaged by ESD if you don't pay attention to ESD protection. SGMICRO recommends that all integrated circuits be handled with appropriate precautions. Failure to observe proper handling and installation procedures

can cause damage. ESD damage can range from subtle performance degradation to complete device failure. Precision integrated circuits may be more susceptible to damage because very small parametric changes could cause the device not to meet its published specifications.

DISCLAIMER

SG Micro Corp reserves the right to make any change in circuit design, or specifications without prior notice.

PIN CONFIGURATIONS

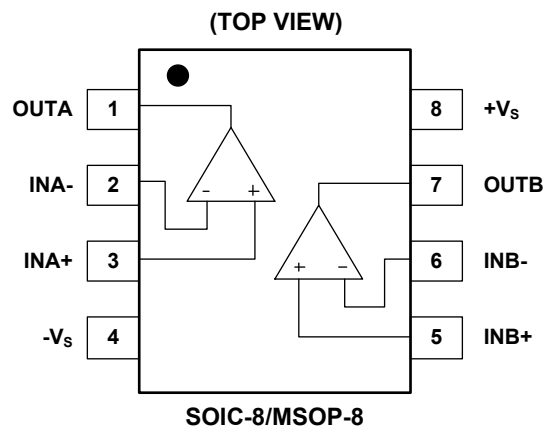

ELECTRICAL CHARACTERISTICS

(V_S = 5.0V, V_{CM} = 0V, C_L = 15pF, typical values are at T_A = +25°C, unless otherwise noted.)

PARAMETER	SYMBOL	CONDITIONS	MIN	TYP	MAX	UNITS
Operating Supply Voltage ⁽¹⁾	V _S		2.7		5.5	V
Input Common Mode Voltage Range ⁽²⁾	V _{CM}		-0.1		V _S + 0.1	V
Input Offset Voltage ⁽³⁾	V _{OS}	V _S = 5V, V _{CM} = 0V		0.8	4.9	mV
		-40°C ≤ T _A ≤ +85°C			5.8	
Input Hysteresis ⁽⁴⁾	V _{HYST}	V _S = 5V, V _{CM} = 0V		2.5		mV
Output Short-Circuit Current	I _{SOURCE}	V _S = 5V, Out to V _S /2	22.5	34		mA
		-40°C ≤ T _A ≤ +85°C	19			
	I _{SINK}	V _S = 5V, Out to V _S /2		-33	-25.5	
		-40°C ≤ T _A ≤ +85°C			-21	
Common Mode Rejection Ratio ⁽⁵⁾	CMRR	V _S = 5V, V _{CM} = 0V to 5V	59	78		dB
		-40°C ≤ T _A ≤ +85°C	54			
Power Supply Rejection Ratio	PSRR	V _{CM} = 0V, V _S = 2.7V to 5.5V	58	71		dB
		-40°C ≤ T _A ≤ +85°C	54			
Output Voltage Swing from Rail	V _{OH}	V _S = 5V, I _{OUT} = 4mA		188	275	mV
		-40°C ≤ T _A ≤ +85°C			305	
	V _{OL}	V _S = 5V, I _{OUT} = -4mA		179	222	
		-40°C ≤ T _A ≤ +85°C			248	
Supply Current	I _S	V _S = 3V, I _{OUT} = 0		45	60	μA
		-40°C ≤ T _A ≤ +85°C			70	
		V _S = 5V, I _{OUT} = 0		50	69	
		-40°C ≤ T _A ≤ +85°C			83	
Propagation Delay (High to Low)		V _S = 3V, Overdrive = 10mV		155		ns
		V _S = 3V, Overdrive = 100mV		95		
Propagation Delay (Low to High)		V _S = 3V, Overdrive = 10mV		145		ns
		V _S = 3V, Overdrive = 100mV		120		
Rise Time	t _{RISE}	V _S = 3V, Overdrive = 10mV		10		ns
		V _S = 3V, Overdrive = 100mV		8		
Fall Time	t _{FALL}	V _S = 3V, Overdrive = 10mV		8		ns
		V _S = 3V, Overdrive = 100mV		6		

NOTES:

- Inferred from PSRR test.
- Inferred from PD test. Note also that either or both inputs can be driven to the absolute maximum limit (0.1V beyond either supply rail) without damage or false output inversion.
- V_{OS} is defined as the center of the input-referred hysteresis zone. See Figure 1.
- The input-referred trip points are the extremities of the differential input voltage required to make the comparator output change state. The difference between the upper and lower trip points is equal to the width of the input-referred hysteresis zone. See Figure 1.
- Specified over the full input common mode voltage range (V_{CM}).

TYPICAL PERFORMANCE CHARACTERISTICS

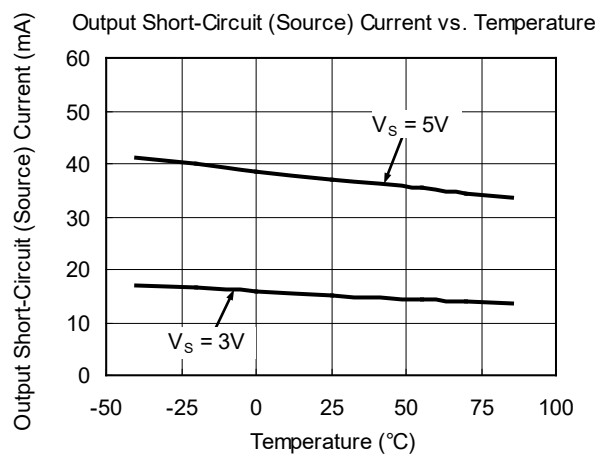
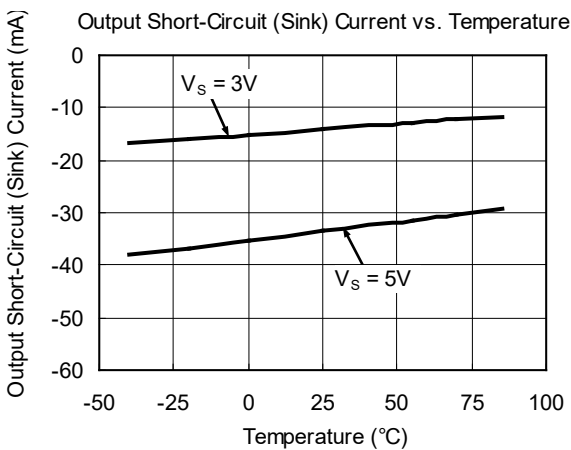
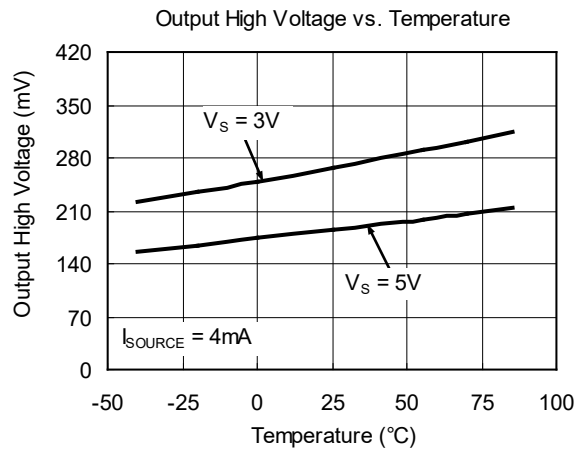
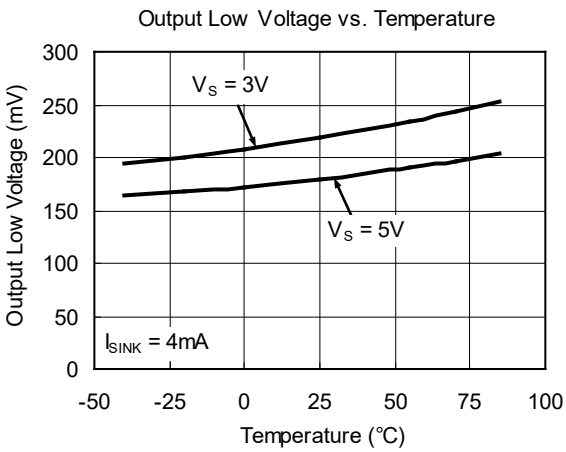
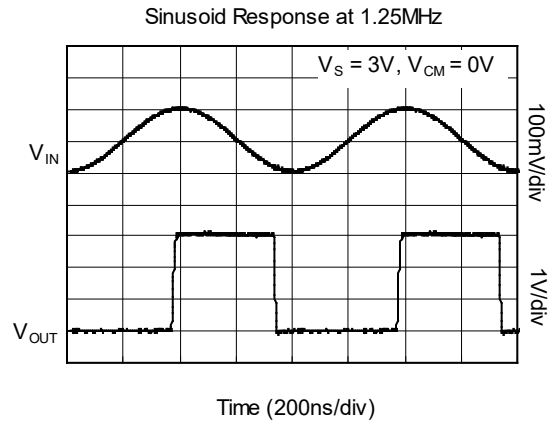
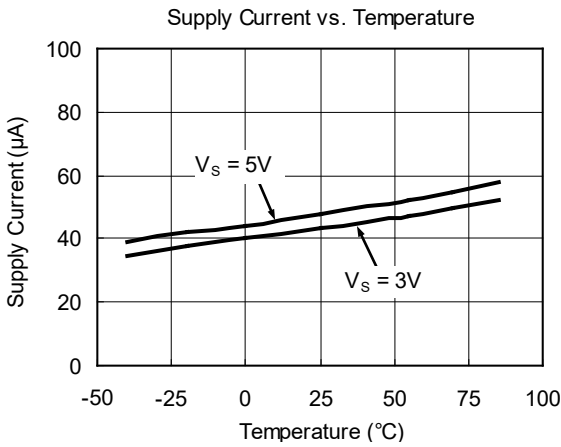

TYPICAL PERFORMANCE CHARACTERISTICS (continued)

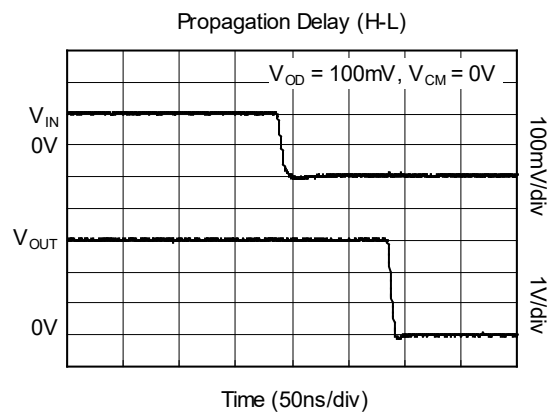
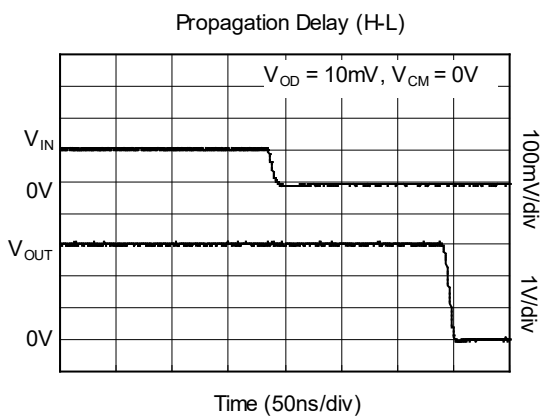
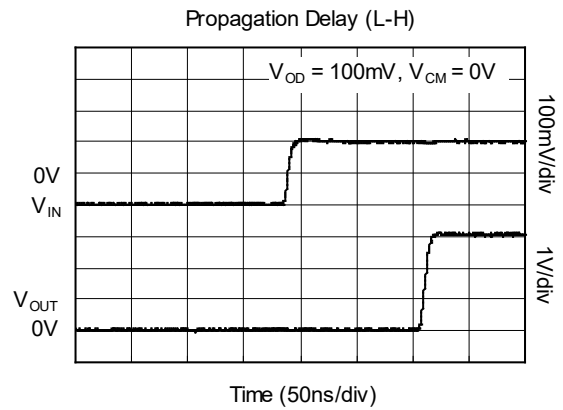
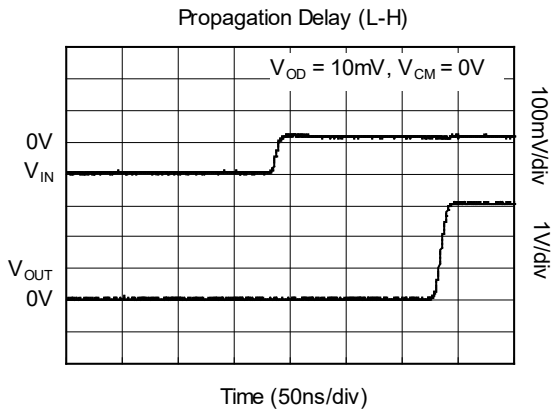
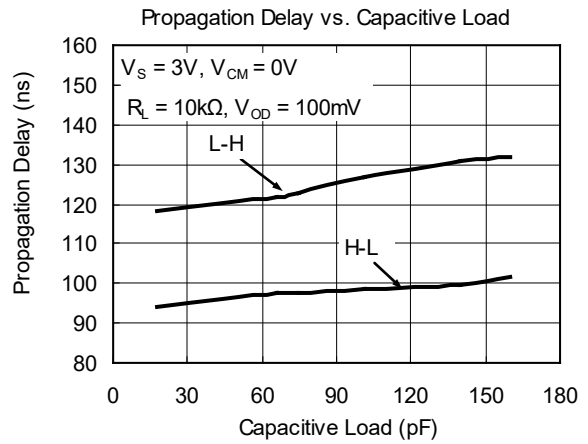
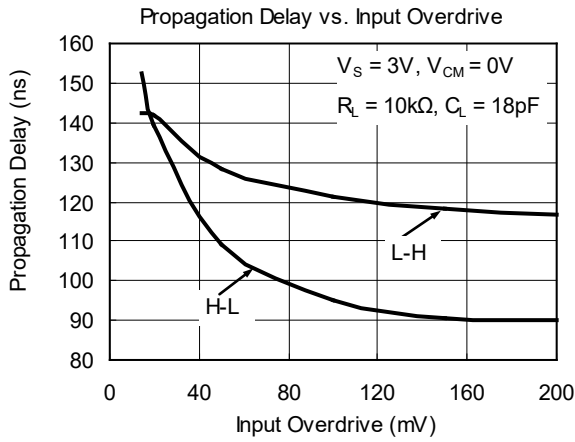

TYPICAL PERFORMANCE CHARACTERISTICS (continued)

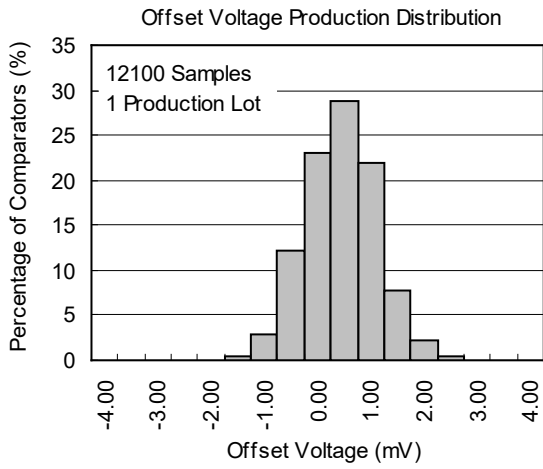

REVISION HISTORY

NOTE: Page numbers for previous revisions may differ from page numbers in the current version.

Changes from Original (NOVEMBER 2014) to REV.A	Page
Changed from product preview to production data.....	All

PACKAGE OUTLINE DIMENSIONS

SOIC-8

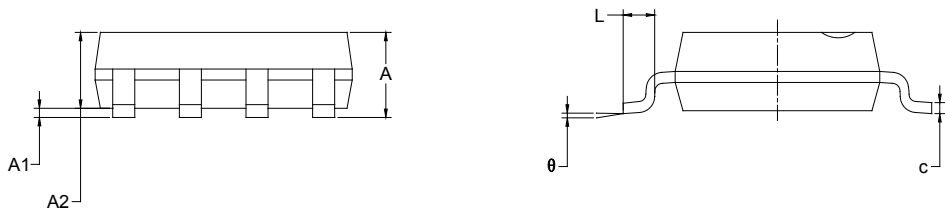
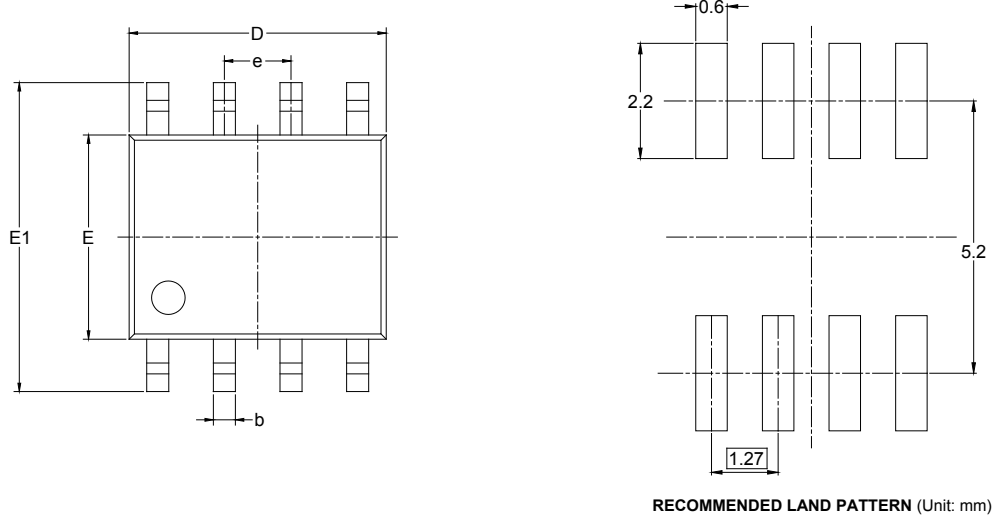

Symbol	Dimensions In Millimeters		Dimensions In Inches	
	MIN	MAX	MIN	MAX
A	1.350	1.750	0.053	0.069
A1	0.100	0.250	0.004	0.010
A2	1.350	1.550	0.053	0.061
b	0.330	0.510	0.013	0.020
c	0.170	0.250	0.006	0.010
D	4.700	5.100	0.185	0.200
E	3.800	4.000	0.150	0.157
E1	5.800	6.200	0.228	0.244
e	1.27 BSC		0.050 BSC	
L	0.400	1.270	0.016	0.050
θ	0°	8°	0°	8°

PACKAGE OUTLINE DIMENSIONS

MSOP-8

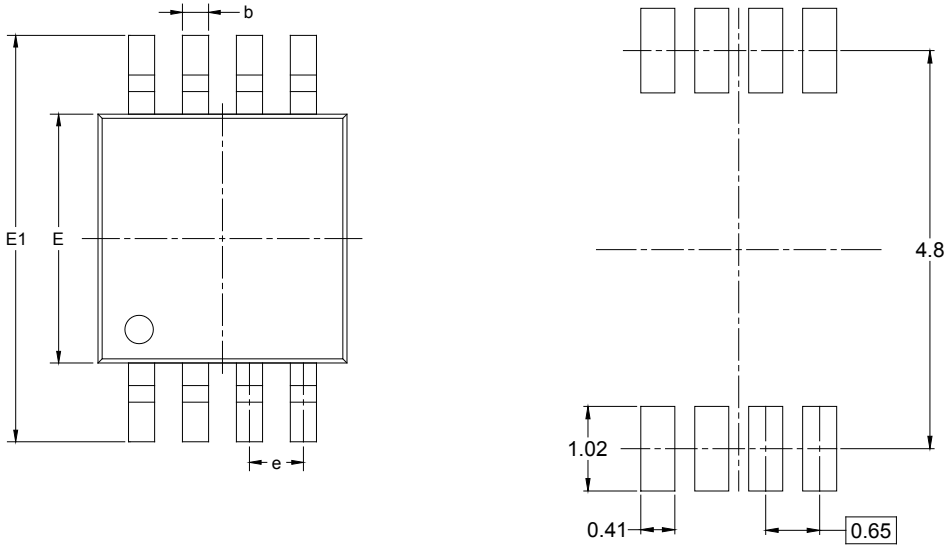

RECOMMENDED LAND PATTERN (Unit: mm)

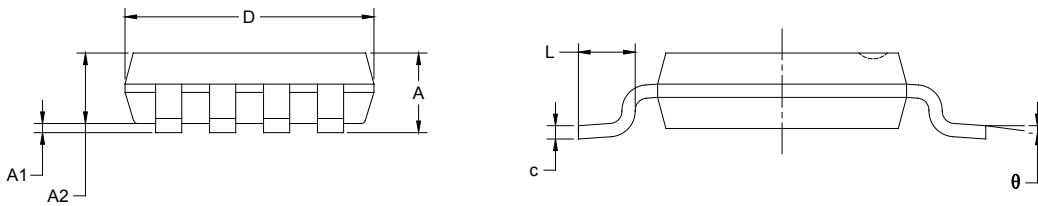

Symbol	Dimensions In Millimeters		Dimensions In Inches	
	MIN	MAX	MIN	MAX
A	0.820	1.100	0.032	0.043
A1	0.020	0.150	0.001	0.006
A2	0.750	0.950	0.030	0.037
b	0.250	0.380	0.010	0.015
c	0.090	0.230	0.004	0.009
D	2.900	3.100	0.114	0.122
E	2.900	3.100	0.114	0.122
E1	4.750	5.050	0.187	0.199
e	0.650 BSC		0.026 BSC	
L	0.400	0.800	0.016	0.031
θ	0°	6°	0°	6°

PACKAGE INFORMATION

TAPE AND REEL INFORMATION

REEL DIMENSIONS

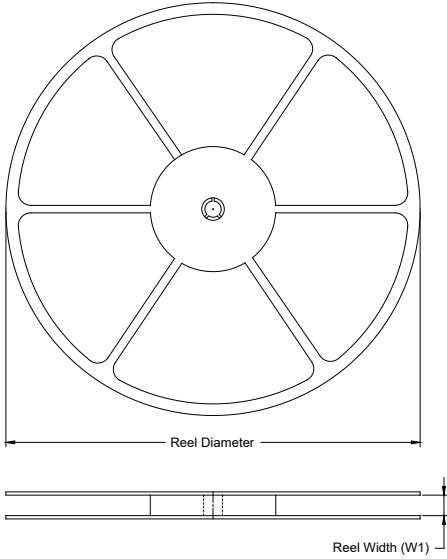

TAPE DIMENSIONS

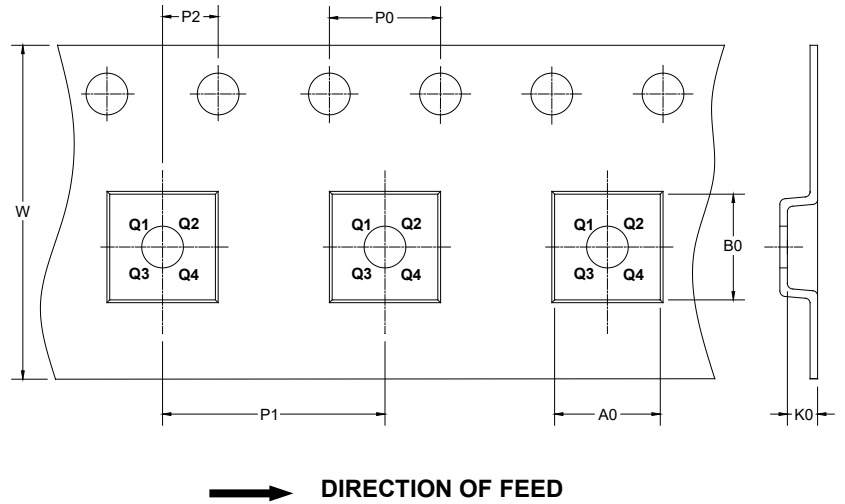

NOTE: The picture is only for reference. Please make the object as the standard.

KEY PARAMETER LIST OF TAPE AND REEL

Package Type	Reel Diameter	Reel Width W1 (mm)	A0 (mm)	B0 (mm)	K0 (mm)	P0 (mm)	P1 (mm)	P2 (mm)	W (mm)	Pin1 Quadrant
SOIC-8	13"	12.4	6.40	5.40	2.10	4.0	8.0	2.0	12.0	Q1
MSOP-8	13"	12.4	5.20	3.30	1.50	4.0	8.0	2.0	12.0	Q1

DD0001

PACKAGE INFORMATION

CARTON BOX DIMENSIONS



NOTE: The picture is only for reference. Please make the object as the standard.

KEY PARAMETER LIST OF CARTON BOX

Reel Type	Length (mm)	Width (mm)	Height (mm)	Pizza/Carton
13"	386	280	370	5

DD0002

单击下面可查看定价，库存，交付和生命周期等信息

[>>SGMICRO\(圣邦微电子\)](#)