

GENERAL DESCRIPTION

The SGM4552 is a 1-bit, non-inverting, bidirectional voltage-level translator which features two independent configurable power-supply lines. The A and B ports track the V_{CCA} supply and V_{CCB} supply respectively. The supply voltage range is 1.65V to 5.5V for A port and 2.3V to 5.5V for B port. The device provides a bidirectional translation function between the different voltage nodes (including 1.8V, 2.5V, 3.3V and 5V).

The SGM4552 has an output enable (OE) function, which controls the inputs and outputs states. When OE goes low, all I/Os enter into the high-impedance state. It is beneficial for reducing quiescent current consumption. When V_{CCA} is powered, OE has an internal pull-down current source.

The SGM4552 is available in Green SOT-23-6, SC70-6 and UTDFN-1.45×1-6L packages. It operates over an ambient temperature range of -40°C to +85°C.

FEATURES

- **Power Supply Voltage Ranges ($V_{CCA} \leq V_{CCB}$)**
 - ◆ **A Port: 1.65V to 5.5V**
 - ◆ **B Port: 2.3V to 5.5V**
- **Direction-Control Signal is Not Required**
- **Data Rates**
 - ◆ **Push-Pull: 24Mbps**
 - ◆ **Open-Drain: 2Mbps**
- **Support V_{CCA} or V_{CCB} Isolation**
 - ◆ **When V_{CCA} or V_{CCB} is Low, Device Enters Power-Down Mode**
- **No Specific Power Sequences Required for V_{CCA} and V_{CCB}**
- **Support Power-Down Mode**
- **-40°C to +85°C Operating Temperature Range**
- **Available in Green UTDFN-1.45×1-6L, SOT-23-6 and SC70-6 Packages**

APPLICATIONS

Universal Asynchronous Receiver/Transmitter
I²C/SMBus Interfaces
General Purpose I/O (GPIO)

TYPICAL APPLICATION

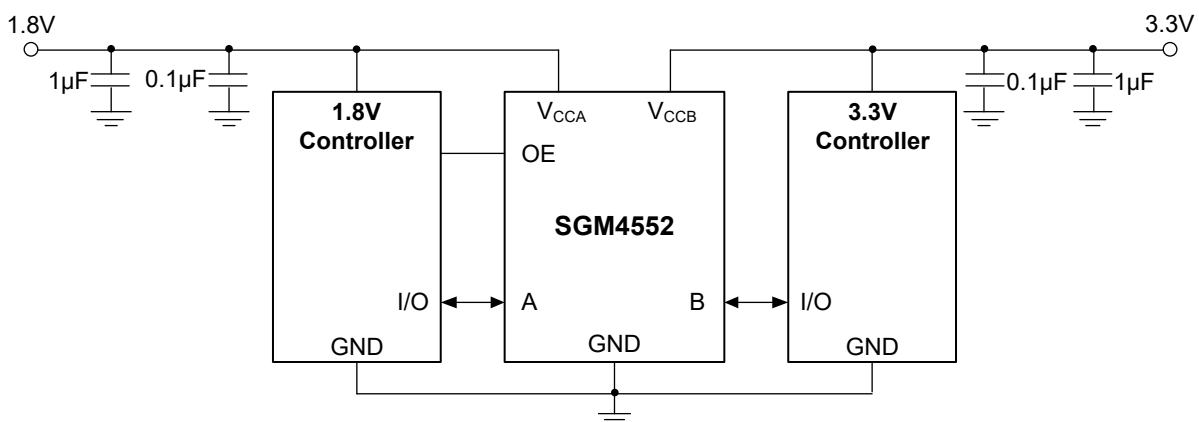

Figure 1. Typical Application Circuit

PACKAGE/ORDERING INFORMATION

MODEL	PACKAGE DESCRIPTION	SPECIFIED TEMPERATURE RANGE	ORDERING NUMBER	PACKAGE MARKING	PACKING OPTION
SGM4552	SC70-6	-40°C to +85°C	SGM4552YC6G/TR	SL1XX	Tape and Reel, 3000
	SOT-23-6	-40°C to +85°C	SGM4552YN6G/TR	SL3XX	Tape and Reel, 3000
	UTDFN-1.45×1-6L	-40°C to +85°C	SGM4552YUDL6G/TR	NAX	Tape and Reel, 5000

MARKING INFORMATION

NOTE: X = Date Code. XX = Date Code.

SOT-23-6/SC70-6

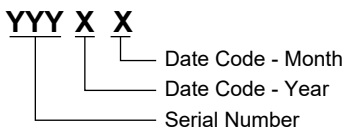

UTDFN-1.45×1-6L

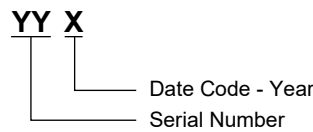

Green (RoHS & HSF): SG Micro Corp defines "Green" to mean Pb-Free (RoHS compatible) and free of halogen substances. If you have additional comments or questions, please contact your SGMICRO representative directly.

ABSOLUTE MAXIMUM RATINGS

- Supply Voltage Range
- V_{CCA} -0.3V to 6V
- V_{CCB} -0.3V to 6V
- Input Voltage Range, V_I
- A Port, B Port, OE -0.3V to 6V
- Output Voltage Range for the High-Impedance or Power-Off State, V_O
- A Port -0.3V to 6V
- B Port -0.3V to 6V
- Output Voltage Range for the High or Low State, V_O
- A Port -0.3V to V_{CCA} + 0.3V
- B Port -0.3V to V_{CCB} + 0.3V
- Input Clamp Current, I_{IK} (V_I < 0) -50mA
- Output Clamp Current, I_{OK} (V_O < 0) -50mA
- Continuous Output Current, I_O ±50mA
- Continuous Current through V_{CCA}, V_{CCB}, or GND ±100mA
- Junction Temperature +150°C
- Storage Temperature Range -65°C to +150°C
- Lead Temperature (Soldering, 10s) +260°C
- ESD Susceptibility
- HBM 4000V
- MM 300V

OVERSTRESS CAUTION

Stresses beyond those listed in Absolute Maximum Ratings may cause permanent damage to the device. Exposure to absolute maximum rating conditions for extended periods may affect reliability. Functional operation of the device at any conditions beyond those indicated in the Recommended Operating Conditions section is not implied.

ESD SENSITIVITY CAUTION

This integrated circuit can be damaged if ESD protections are not considered carefully. SGMICRO recommends that all integrated circuits be handled with appropriate precautions. Failure to observe proper handling and installation procedures can cause damage. ESD damage can range from subtle performance degradation to complete device failure. Precision integrated circuits may be more susceptible to damage because even small parametric changes could cause the device not to meet the published specifications.

DISCLAIMER

SG Micro Corp reserves the right to make any change in circuit design, or specifications without prior notice.

RECOMMENDED OPERATING CONDITIONS

- Operating Temperature Range -40°C to +85°C

PIN CONFIGURATIONS

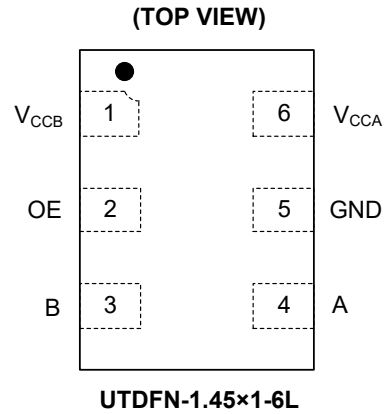
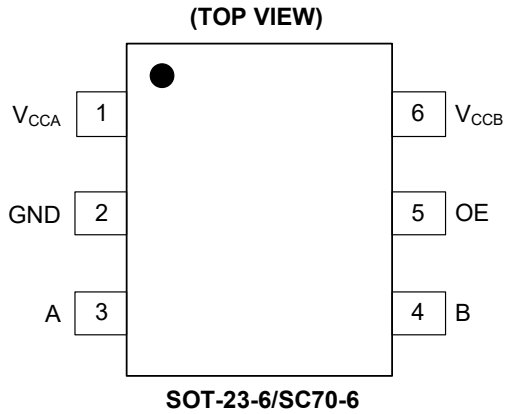

PIN DESCRIPTION

PIN		NAME	FUNCTION
SOT-23-6/SC70-6	UTDFN-1.45x1-6L		
1	6	V _{CCA}	Supply Voltage on A Port. It can be operated from 1.65V to 5.5V, and V _{CCA} is always ≤ V _{CCB} .
2	5	GND	Ground.
3	4	A	Input/Output A. It tracks the V _{CCA} supply.
4	3	B	Input/Output B. It tracks the V _{CCB} supply.
5	2	OE	Output Enable Control Pin. Active high. When OE goes low, all outputs enter into the high-impedance state. It tracks the V _{CCA} supply.
6	1	V _{CCB}	Supply Voltage on B Port. It can be operated from 2.3V to 5.5V.

PACKAGE OUTLINE DIMENSIONS

SOT-23-6

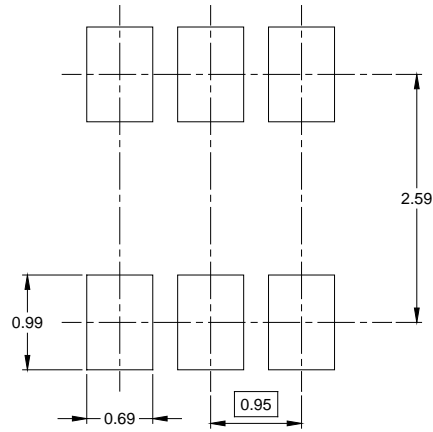
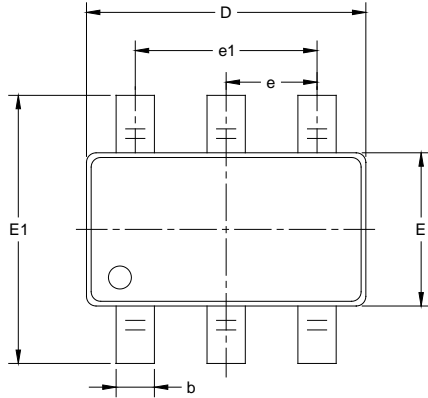

RECOMMENDED LAND PATTERN (Unit: mm)

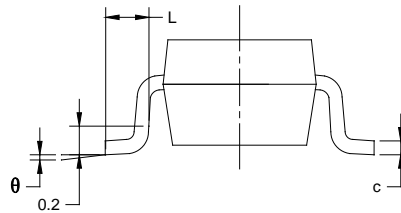
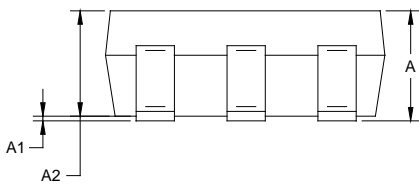

Symbol	Dimensions In Millimeters		Dimensions In Inches	
	MIN	MAX	MIN	MAX
A	1.050	1.250	0.041	0.049
A1	0.000	0.100	0.000	0.004
A2	1.050	1.150	0.041	0.045
b	0.300	0.500	0.012	0.020
c	0.100	0.200	0.004	0.008
D	2.820	3.020	0.111	0.119
E	1.500	1.700	0.059	0.067
E1	2.650	2.950	0.104	0.116
e	0.950 BSC		0.037 BSC	
e1	1.900 BSC		0.075 BSC	
L	0.300	0.600	0.012	0.024
θ	0°	8°	0°	8°

NOTES:

1. Body dimensions do not include mode flash or protrusion.
2. This drawing is subject to change without notice.

PACKAGE OUTLINE DIMENSIONS

SC70-6

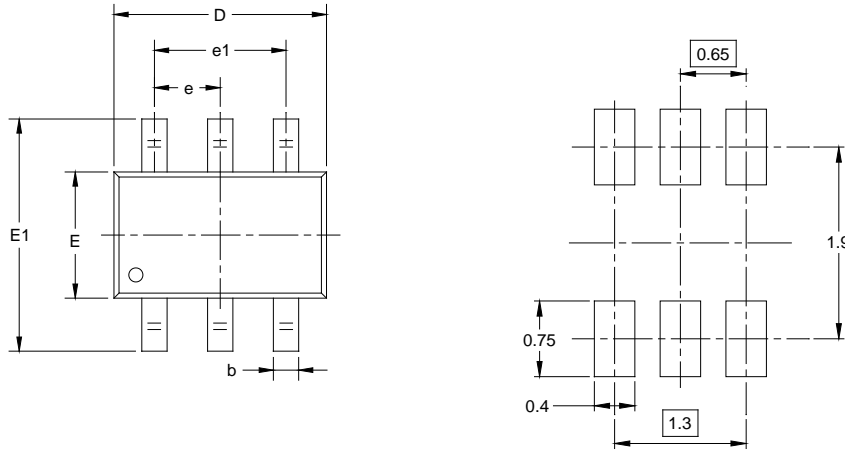

RECOMMENDED LAND PATTERN (Unit: mm)

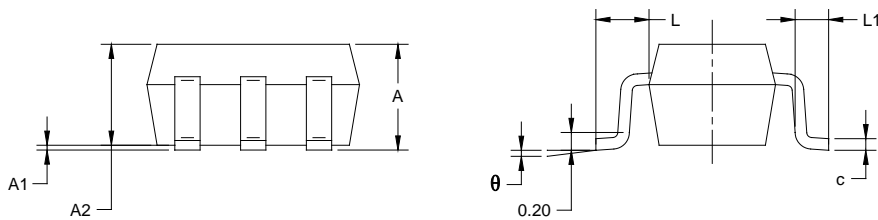

Symbol	Dimensions In Millimeters		Dimensions In Inches	
	MIN	MAX	MIN	MAX
A	0.800	1.100	0.031	0.043
A1	0.000	0.100	0.000	0.004
A2	0.800	1.000	0.031	0.039
b	0.150	0.350	0.006	0.014
c	0.080	0.220	0.003	0.009
D	2.000	2.200	0.079	0.087
E	1.150	1.350	0.045	0.053
E1	2.150	2.450	0.085	0.096
e	0.65 TYP		0.026 TYP	
e1	1.300 BSC		0.051 BSC	
L	0.525 REF		0.021 REF	
L1	0.260	0.460	0.010	0.018
θ	0°	8°	0°	8°

NOTES:
 1. Body dimensions do not include mode flash or protrusion.
 2. This drawing is subject to change without notice.

PACKAGE OUTLINE DIMENSIONS

UTDFN-1.45x1-6L

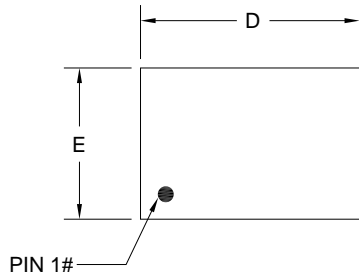

TOP VIEW

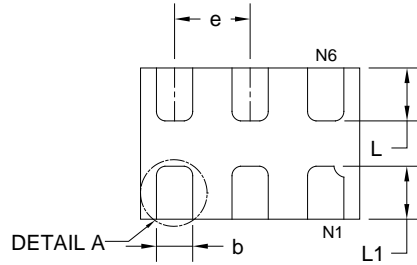

BOTTOM VIEW

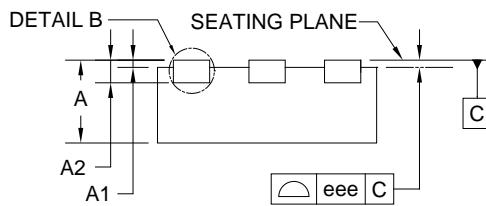

SIDE VIEW

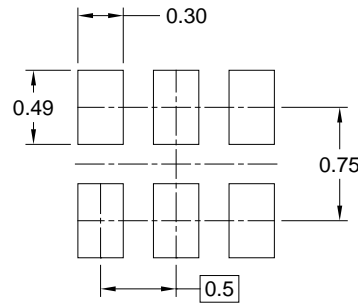

RECOMMENDED LAND PATTERN (Unit: mm)

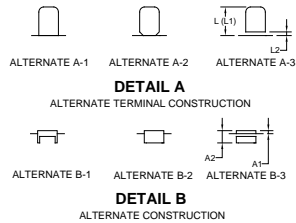

Symbol	Dimensions In Millimeters		Dimensions In Inches	
	MIN	MAX	MIN	MAX
A	0.450	0.600	0.018	0.024
A1	0.000	0.050	0.000	0.002
A2	0.150 REF		0.006 REF	
D	1.374	1.526	0.054	0.060
E	0.924	1.076	0.036	0.042
b	0.150	0.300	0.006	0.012
e	0.500 TYP		0.020 TYP	
eee	0.050		0.002	
L	0.250	0.450	0.010	0.018
L1	0.250	0.500	0.010	0.020
L2	0.000	0.100	0.000	0.004

NOTE: This drawing is subject to change without notice.

PACKAGE INFORMATION

TAPE AND REEL INFORMATION

REEL DIMENSIONS



TAPE DIMENSIONS



NOTE: The picture is only for reference. Please make the object as the standard.

KEY PARAMETER LIST OF TAPE AND REEL

Package Type	Reel Diameter	Reel Width W1 (mm)	A0 (mm)	B0 (mm)	K0 (mm)	P0 (mm)	P1 (mm)	P2 (mm)	W (mm)	Pin1 Quadrant
SOT-23-6	7"	9.5	3.17	3.23	1.37	4.0	4.0	2.0	8.0	Q3
SC70-6	7"	9.5	2.40	2.50	1.20	4.0	4.0	2.0	8.0	Q3
UTDFN-1.45×1-6L	7"	9.5	1.15	1.60	0.75	4.0	4.0	2.0	8.0	Q1

DD0001

PACKAGE INFORMATION

CARTON BOX DIMENSIONS



NOTE: The picture is only for reference. Please make the object as the standard.

KEY PARAMETER LIST OF CARTON BOX

Reel Type	Length (mm)	Width (mm)	Height (mm)	Pizza/Carton
7" (Option)	368	227	224	8
7"	442	410	224	18

DD0002

单击下面可查看定价，库存，交付和生命周期等信息

[>>SGMICRO\(圣邦微电子\)](#)