



LM324

Quad Rail-to-Rail Output Operational Amplifier

GENERAL DESCRIPTION

The LM324 is a quad, high-gain frequency-compensated operational amplifier, which can operate from 3V to 32V single supply or from $\pm 1.5V$ to $\pm 16V$ dual supplies while consuming only 860 μA quiescent current.

The LM324 features low power, low offset voltage and low bias current. It is well suited for a wide range of applications.

The LM324 is available in a Green SOIC-14 package. It is specified over the 0°C to +70°C temperature range.

APPLICATIONS

Wearable Products
Temperature Measurements
Battery-Powered Systems
Sensors
Audio
Active Filters
Communications
Test Equipment

FEATURES

- **Wide Supply Ranges**
 - Single Supply: 3V to 32V
 - Dual Supplies: $\pm 1.5V$ to $\pm 16V$
- **Low Quiescent Current: 860 μA (TYP)**
- **Low Input Offset Voltage: 5.8mV (MAX)**
- **Low Input Offset Current: 20pA (TYP)**
- **Low Input Bias Current: 10pA (TYP)**
- **Minimum Input Common Mode Voltage: $(-V_S) - 0.1V$**
- **Maximum Differential Input Voltage: +32V/-32V**
- **Gain-Bandwidth Product: 1.1MHz**
- **Open-Loop Differential Voltage Gain: 111dB (TYP)**
- **Internal Frequency Compensation**
- **0°C to +70°C Operating Temperature Range**
- **Available in a Green SOIC-14 Package**

LM324

PACKAGE/ORDERING INFORMATION

MODEL	PACKAGE DESCRIPTION	SPECIFIED TEMPERATURE RANGE	ORDERING NUMBER	PACKAGE MARKING	PACKING OPTION
LM324	SOIC-14	0°C to +70°C	LM324ZS14G/TR	LM324ZS14 XXXXX	Tape and Reel, 2500

MARKING INFORMATION

NOTE: XXXXX = Date Code, Trace Code and Vendor Code.

XXXXX

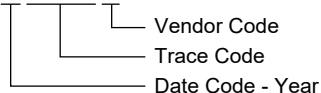

Green (RoHS & HSF): SG Micro Corp defines "Green" to mean Pb-Free (RoHS compatible) and free of halogen substances. If you have additional comments or questions, please contact your SGMICRO representative directly.

ABSOLUTE MAXIMUM RATINGS

Supply Voltage, V_S	-0.3V to 32V
Differential Input Voltage, $V_{ID}^{(1)}$	-32V to 32V
Input Voltage (Either Input)	-0.3V to 32V
Junction Temperature	+150°C
Storage Temperature Range	-65°C to +150°C
Lead Temperature (Soldering, 10s)	+260°C
ESD Susceptibility	
HBM	6000V
CDM	1000V

RECOMMENDED OPERATING CONDITIONS

Input Common Mode Voltage Range	-0.1V to $V_S - 1.5V$
Operating Temperature Range	0°C to +70°C

NOTE:

- Differential voltage is between +IN and -IN.

OVERSTRESS CAUTION

Stresses beyond those listed in Absolute Maximum Ratings may cause permanent damage to the device. Exposure to absolute maximum rating conditions for extended periods may affect reliability. Functional operation of the device at any conditions beyond those indicated in the Recommended Operating Conditions section is not implied.

ESD SENSITIVITY CAUTION

This integrated circuit can be damaged if ESD protections are not considered carefully. SGMICRO recommends that all integrated circuits be handled with appropriate precautions. Failure to observe proper handling and installation procedures can cause damage. ESD damage can range from subtle performance degradation to complete device failure. Precision integrated circuits may be more susceptible to damage because even small parametric changes could cause the device not to meet the published specifications.

DISCLAIMER

SG Micro Corp reserves the right to make any change in circuit design, or specifications without prior notice.

PIN CONFIGURATION

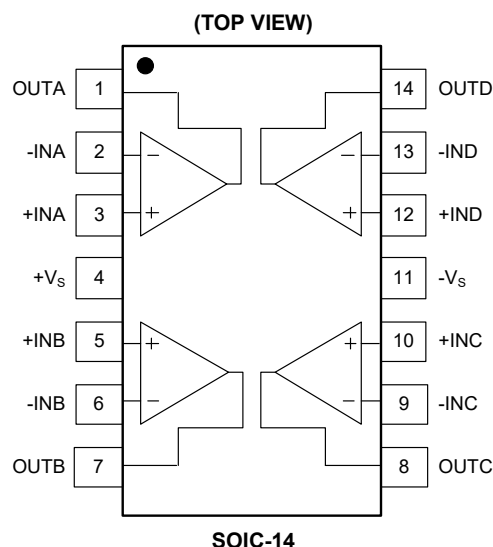

ELECTRICAL CHARACTERISTICS

(At $T_A = +25^\circ\text{C}$, $V_S = 3\text{V}$ to 32V , $R_L = 10\text{k}\Omega$ connected to $V_S/2$, $-0.1\text{V} < V_{CM} < V_S - 1.5\text{V}$, Full = 0°C to $+70^\circ\text{C}$, unless otherwise noted.)

PARAMETER	SYMBOL	CONDITIONS	TEMP	MIN	TYP	MAX	UNITS
Input Characteristics							
Input Offset Voltage	V_{OS}		+25°C		1.2	5.8	mV
			Full			6.6	
Input Bias Current	I_B	$V_{CM} = V_S/2$	+25°C		10		pA
Input Offset Current	I_{OS}	$V_{CM} = V_S/2$	+25°C		20		pA
Maximum Differential Input Voltage	$ V_{ID} $		Full			V_S	V
Input Common Mode Voltage Range	V_{CM}		Full	-0.1		$V_S - 1.5$	V
Common Mode Rejection Ratio	CMRR	$-0.1\text{V} < V_{CM} < V_S - 1.5\text{V}$	+25°C	82	118		dB
			Full	80			
Open-Loop Voltage Gain	A_{OL}	$R_L = 10\text{k}\Omega$ to $V_S/2$	+25°C	92	111		dB
			Full	90			
Output Characteristics							
High-Level Output Voltage	V_{OH}	$R_L = 10\text{k}\Omega$	+25°C		42	60	mV
			Full			70	
Low-Level Output Voltage	V_{OL}	$R_L = 10\text{k}\Omega$	+25°C		110	190	mV
			Full			210	
Output Short-Circuit Current	I_{SC}		+25°C	12	18		mA
Power Supply							
Operating Voltage Range	V_S		Full	3		32	V
Quiescent Current	I_Q	$I_{OUT} = 0\text{A}$	+25°C		860	1120	μA
			Full			1400	
Power Supply Rejection Ratio	PSRR		+25°C	102	122		dB
			Full	100			
Turn-On Time		$G = +1$	+25°C		42		μs
Dynamic Performance ($C_L = 100\text{pF}$)							
Gain-Bandwidth Product	GBP		+25°C		1.1		MHz
Slew Rate	SR	$G = +1$	+25°C		0.35		$\text{V}/\mu\text{s}$
Overload Recovery Time	ORT	$V_{IN} \times G > V_S$	+25°C		2.3		μs
Phase Margin			+25°C		60		°
Noise							
Input Voltage Noise		$f = 0.1\text{Hz}$ to 10Hz	+25°C		8.7		μV_{P-P}
Input Voltage Noise Density	e_n	$f = 1\text{kHz}$	+25°C		36		$\text{nV}/\sqrt{\text{Hz}}$

TYPICAL PERFORMANCE CHARACTERISTICS

At $T_A = +25^\circ\text{C}$, $V_{CM} = V_S/2$, unless otherwise noted.

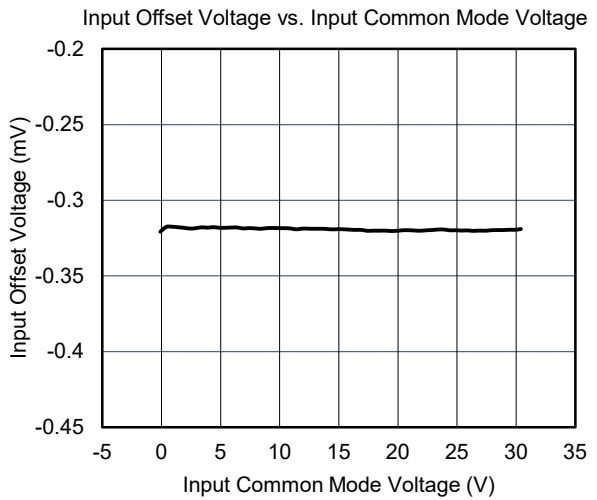
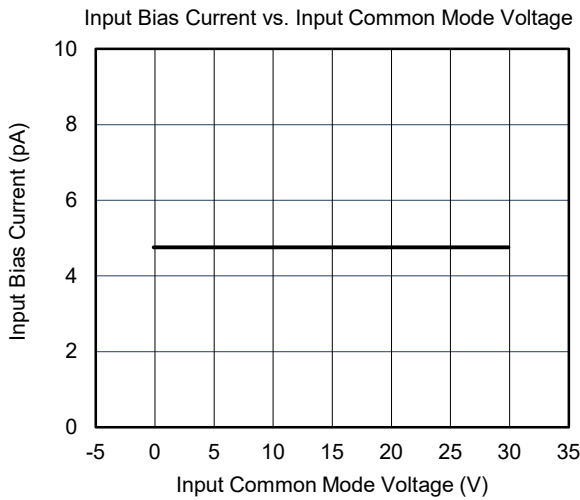
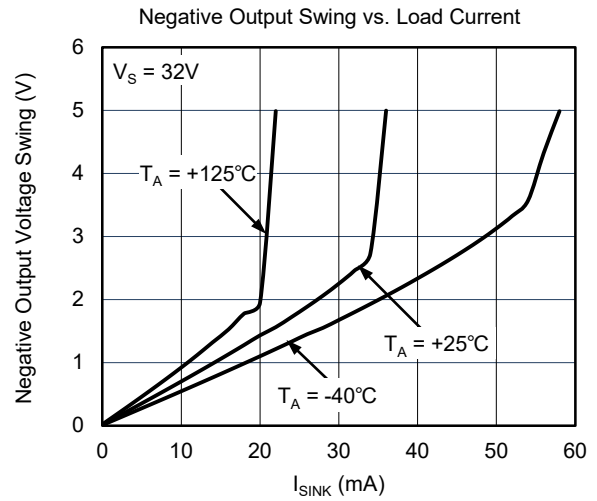
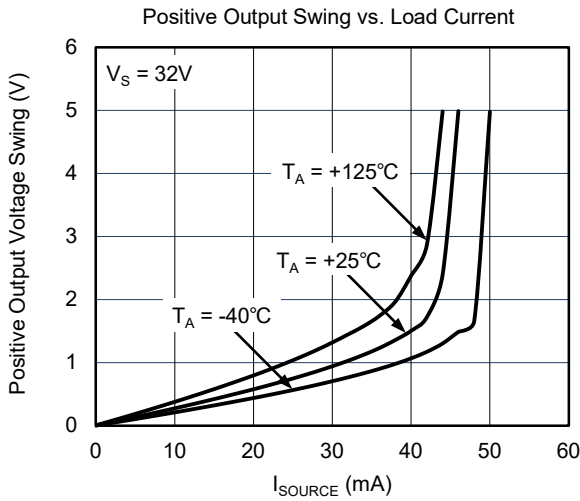
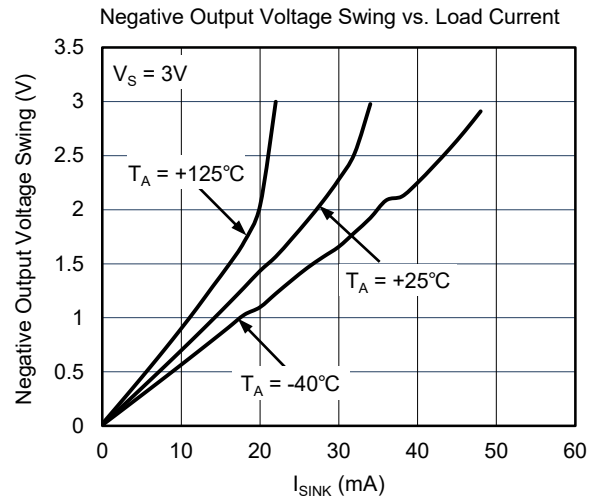
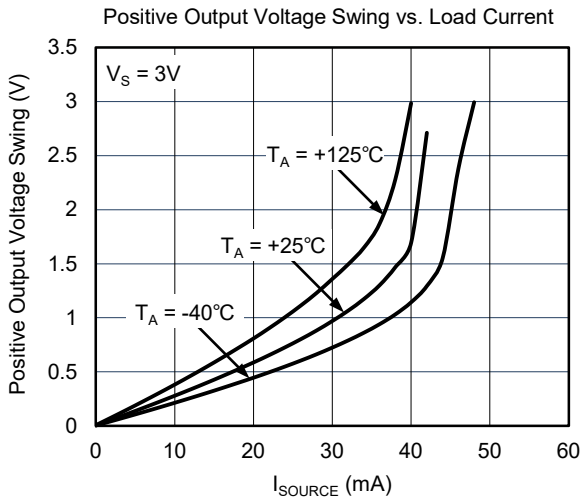

TYPICAL PERFORMANCE CHARACTERISTICS (continued)

At $T_A = +25^\circ\text{C}$, $V_{CM} = V_S/2$, unless otherwise noted.

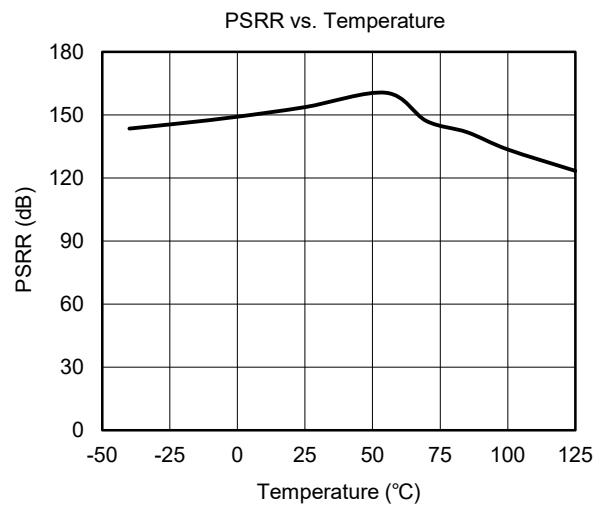
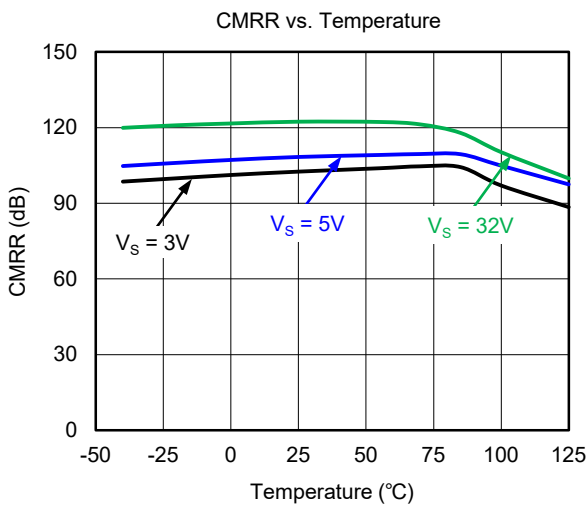
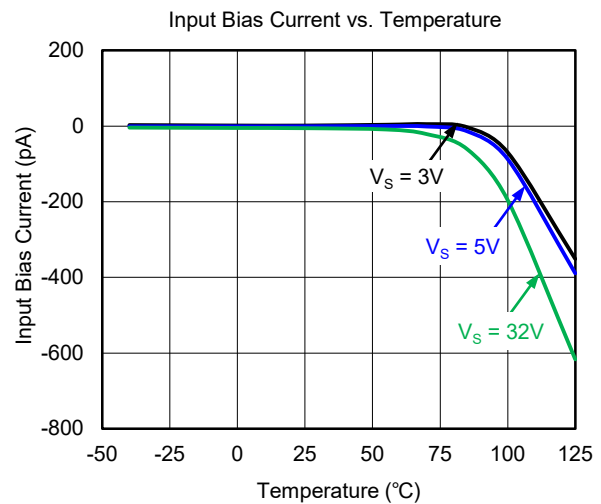
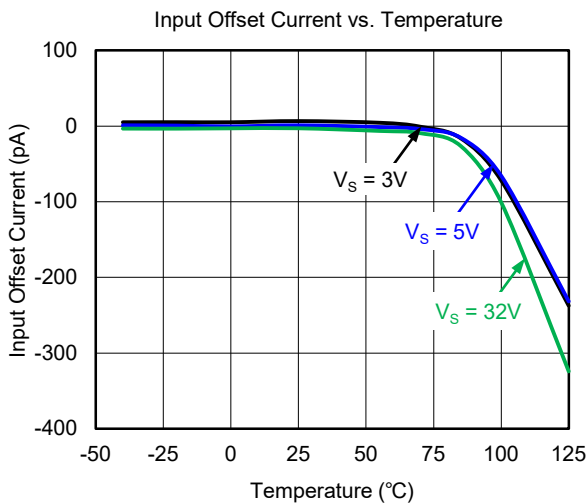
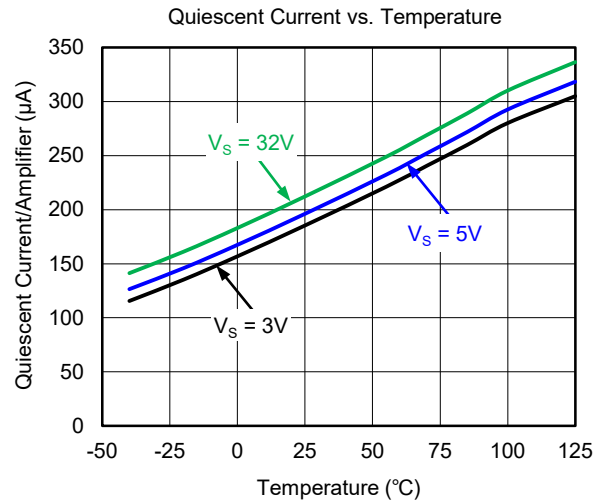
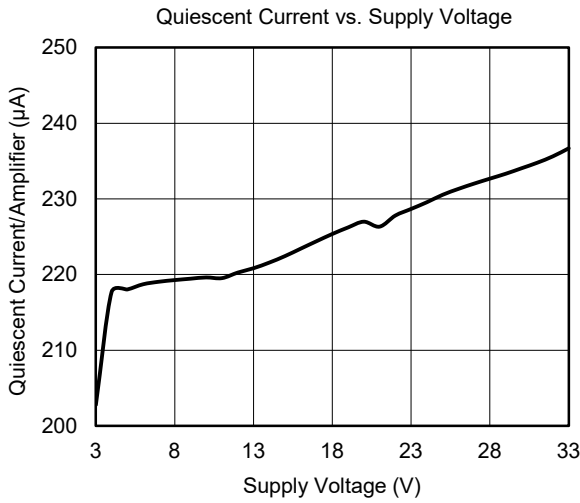

TYPICAL PERFORMANCE CHARACTERISTICS (continued)

At $T_A = +25^\circ\text{C}$, $V_{CM} = V_S/2$, unless otherwise noted.

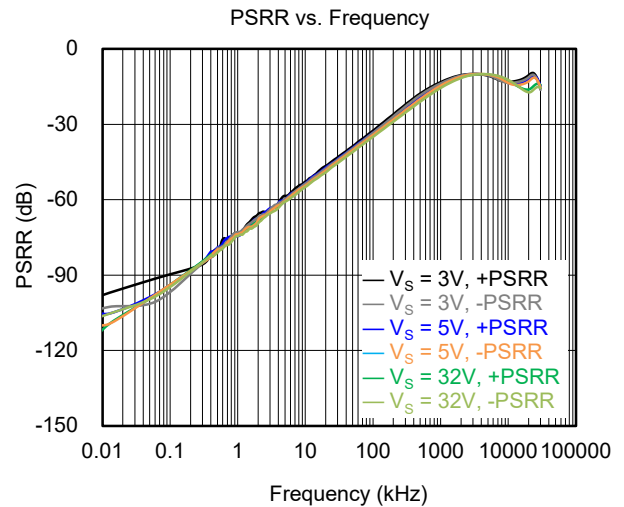
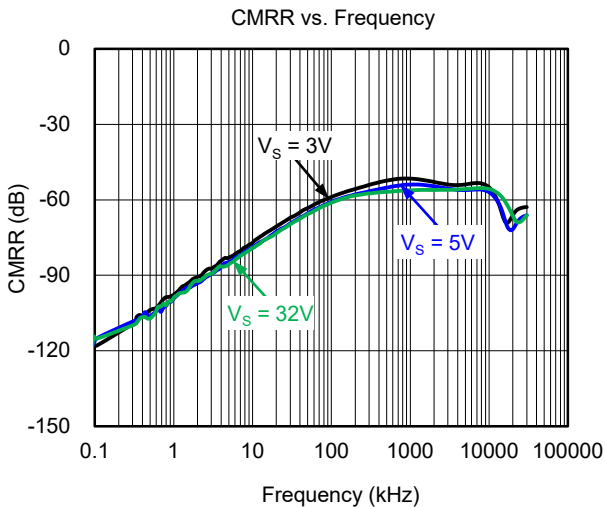
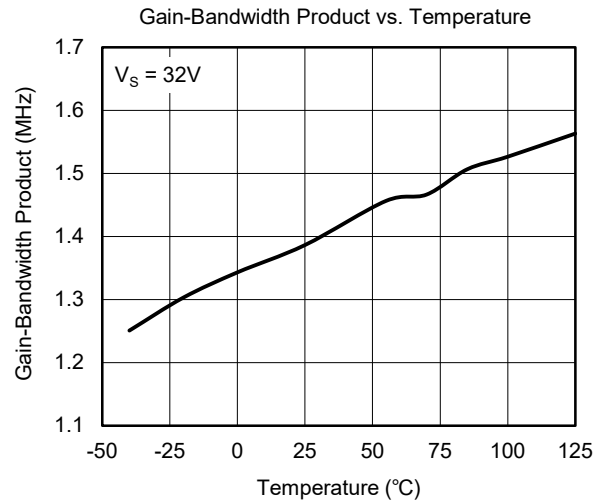
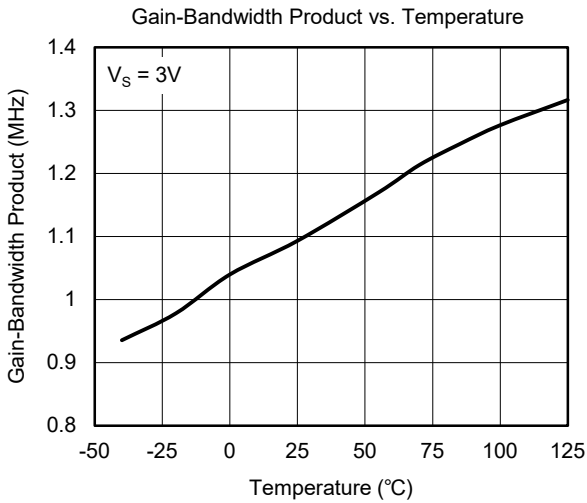
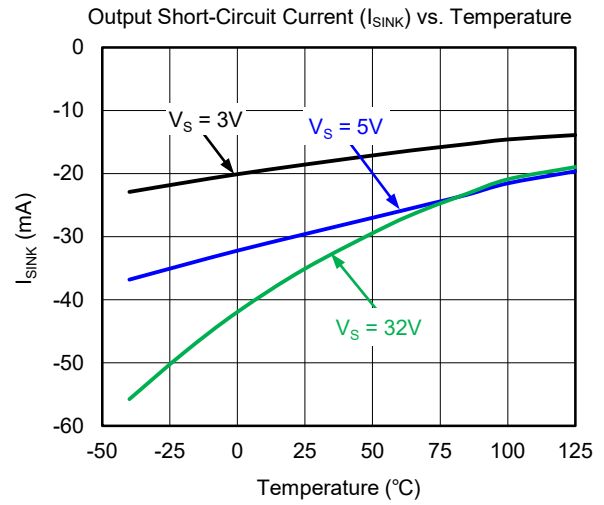
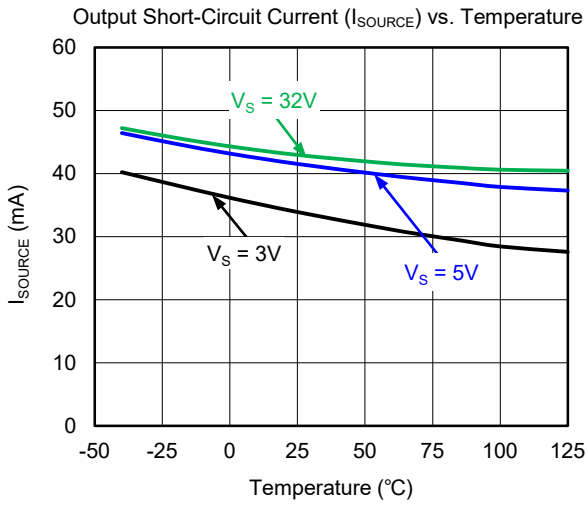

TYPICAL PERFORMANCE CHARACTERISTICS (continued)

At $T_A = +25^\circ\text{C}$, $V_{CM} = V_S/2$, unless otherwise noted.

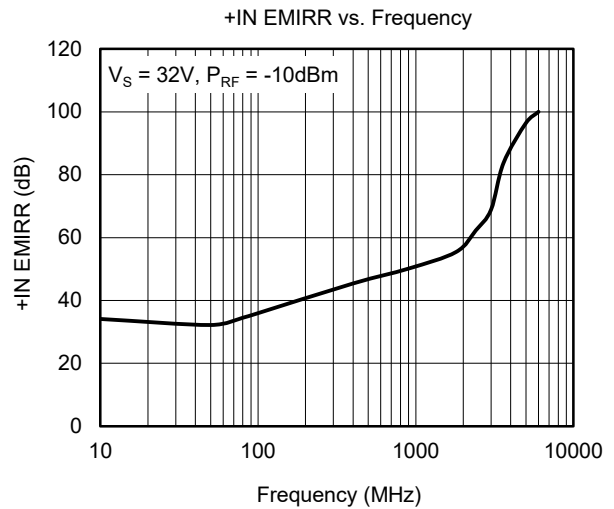
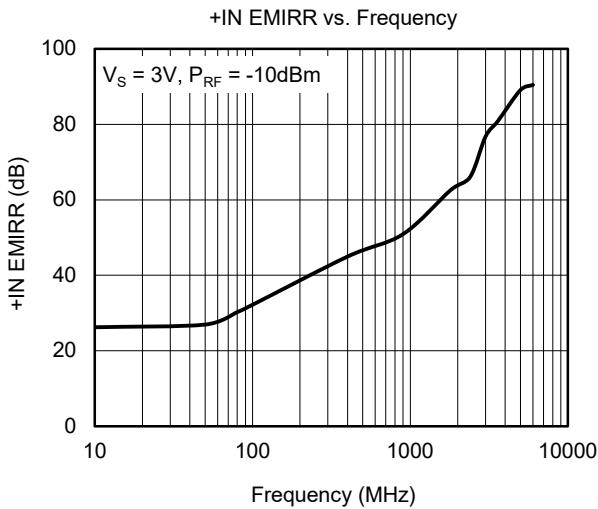
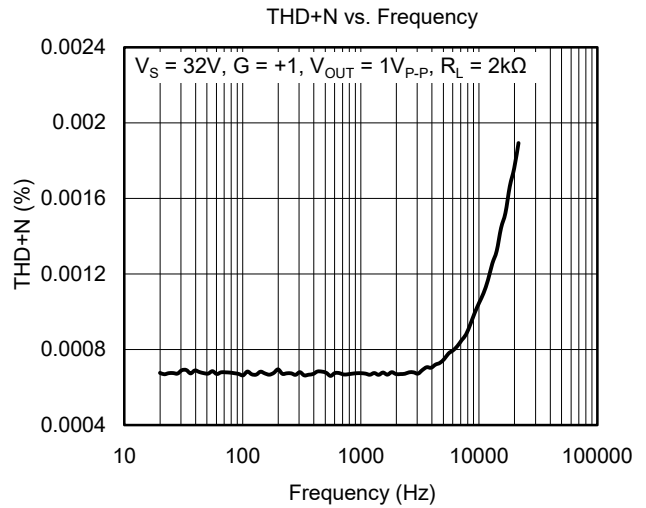
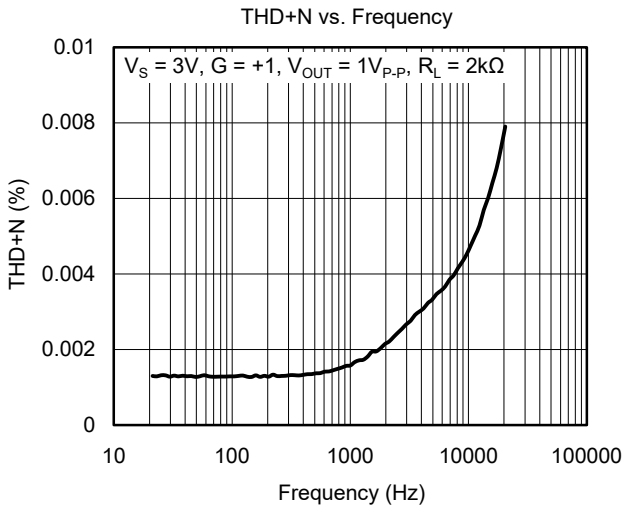
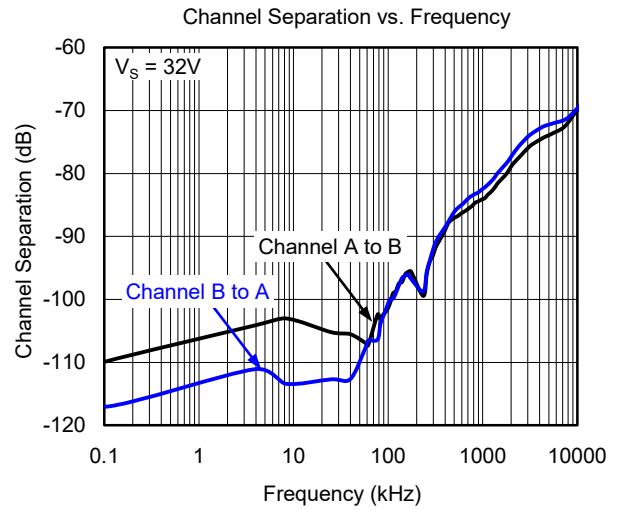
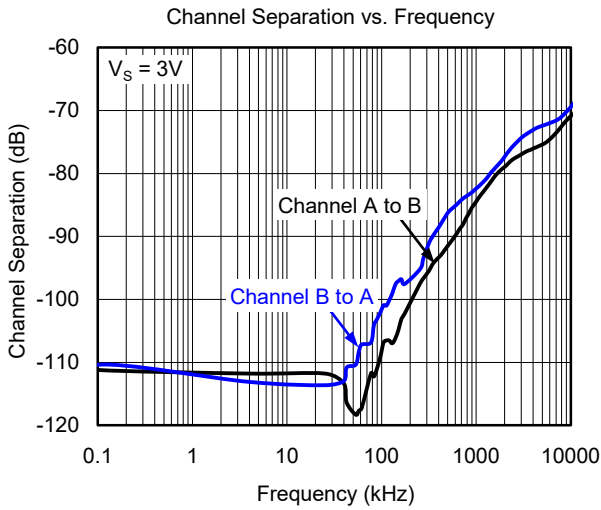

TYPICAL PERFORMANCE CHARACTERISTICS (continued)

At $T_A = +25^\circ\text{C}$, $V_{CM} = V_S/2$, unless otherwise noted.

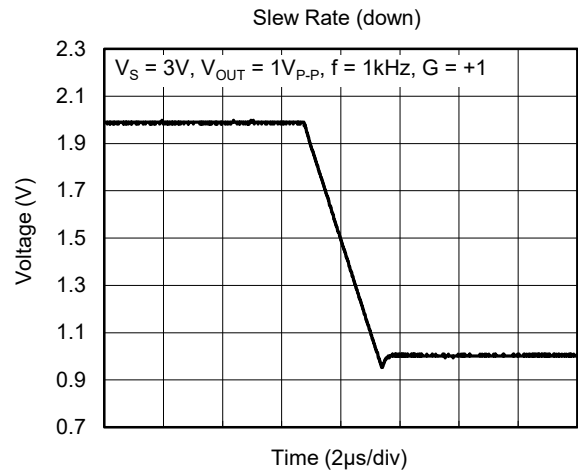
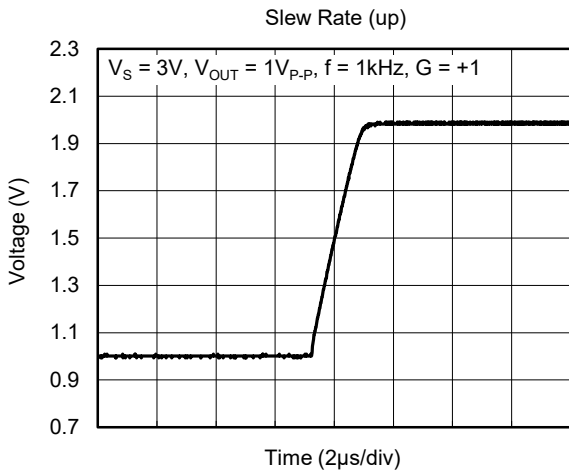
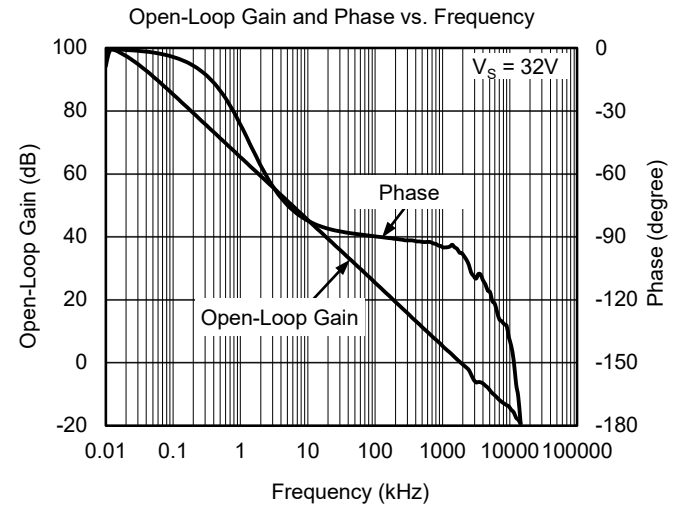
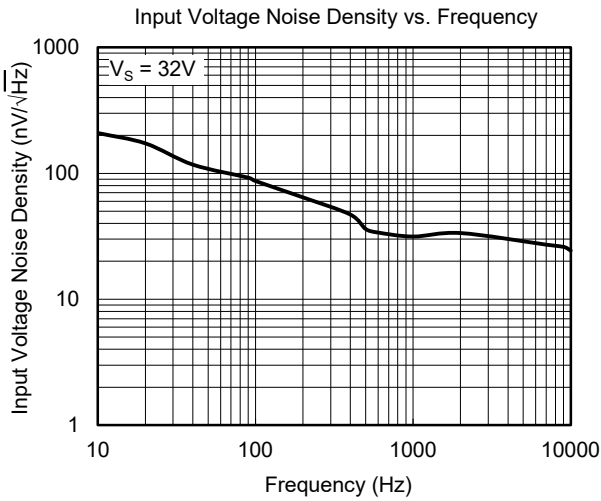
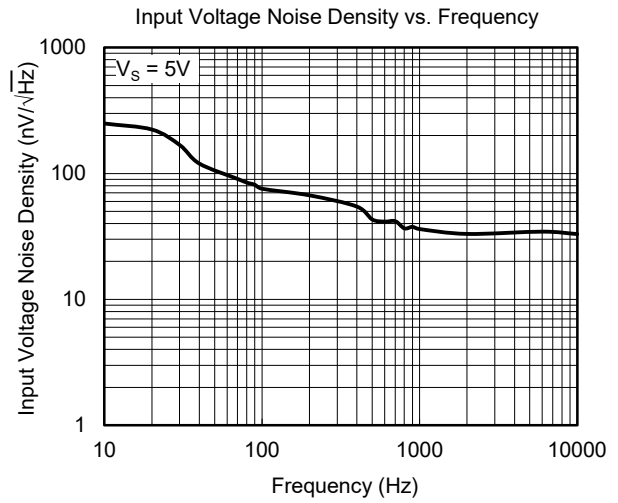
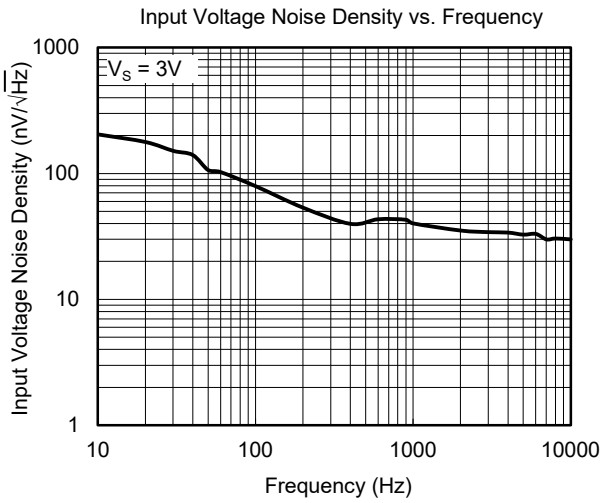

TYPICAL PERFORMANCE CHARACTERISTICS (continued)

At $T_A = +25^\circ\text{C}$, $V_{CM} = V_S/2$, unless otherwise noted.

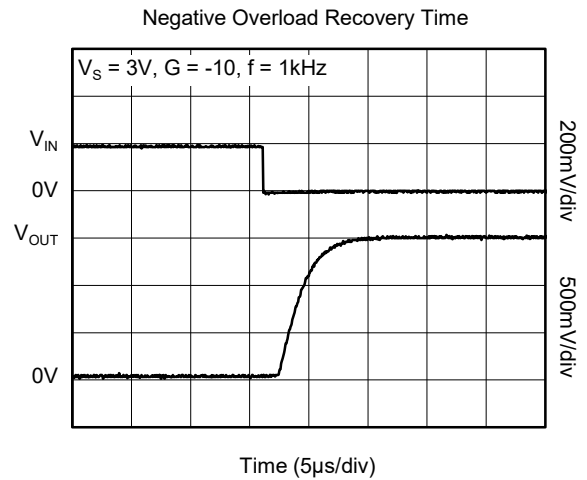
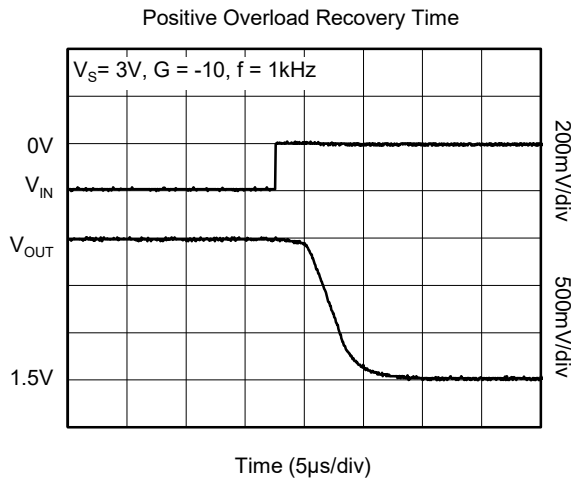
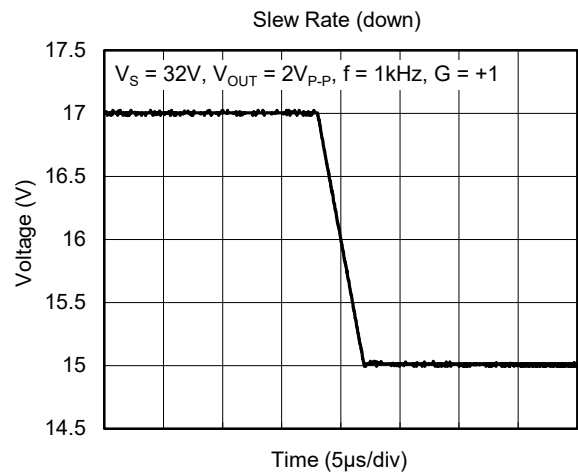
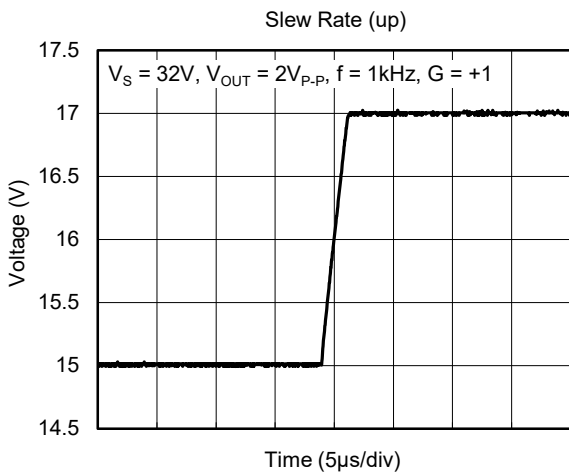
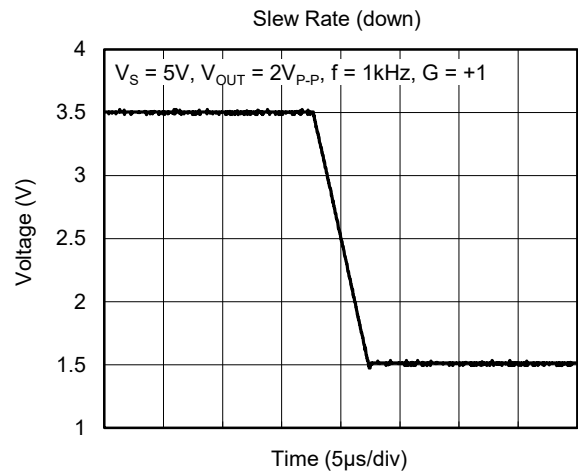
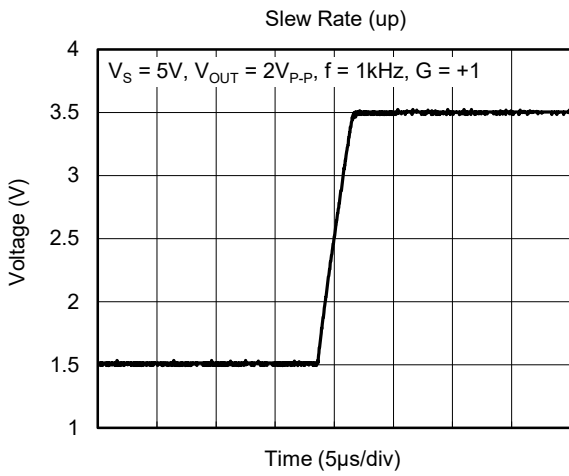

TYPICAL PERFORMANCE CHARACTERISTICS (continued)

At $T_A = +25^\circ\text{C}$, $V_{CM} = V_S/2$, unless otherwise noted.

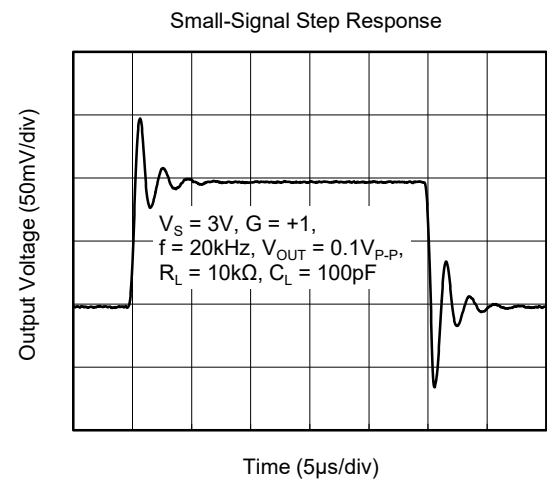
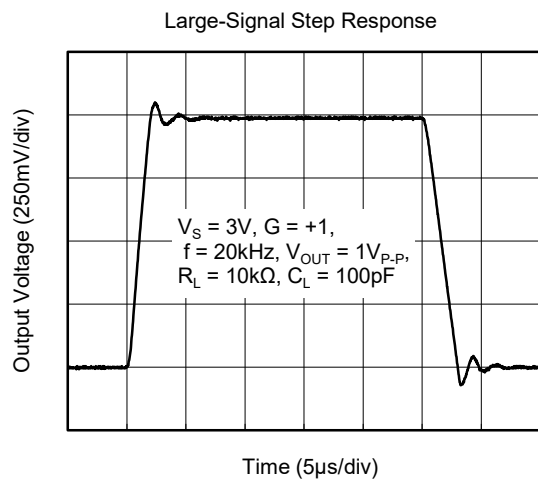
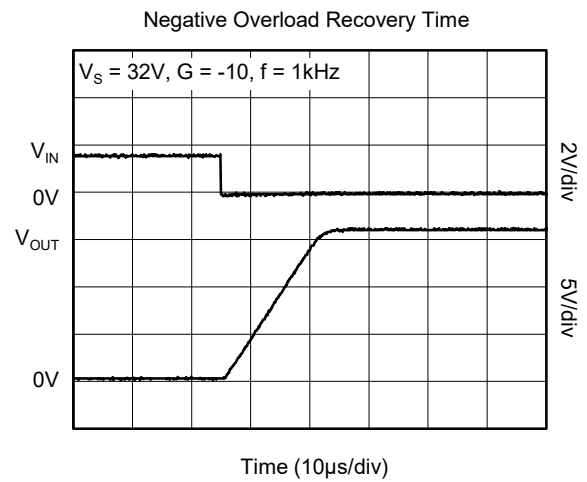
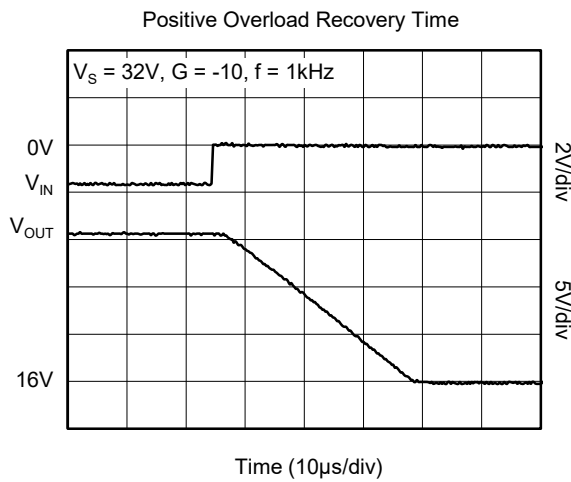
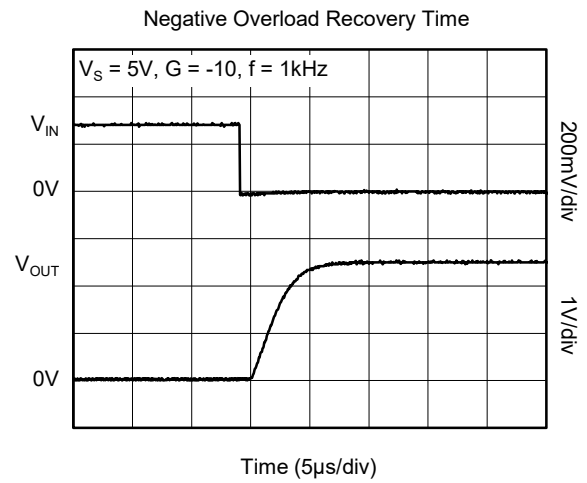
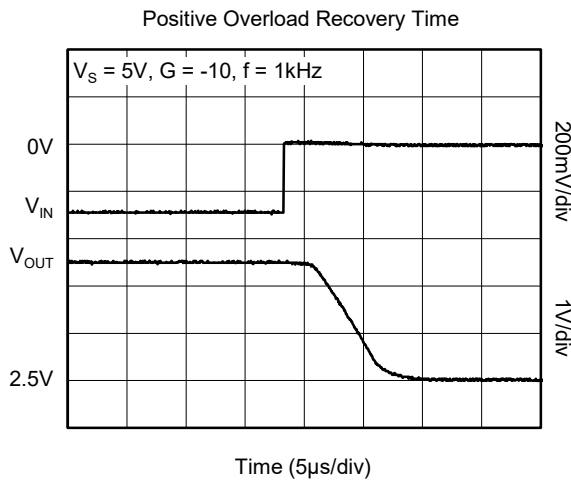

TYPICAL PERFORMANCE CHARACTERISTICS (continued)

At $T_A = +25^\circ\text{C}$, $V_{CM} = V_S/2$, unless otherwise noted.

Large-Signal Step Response

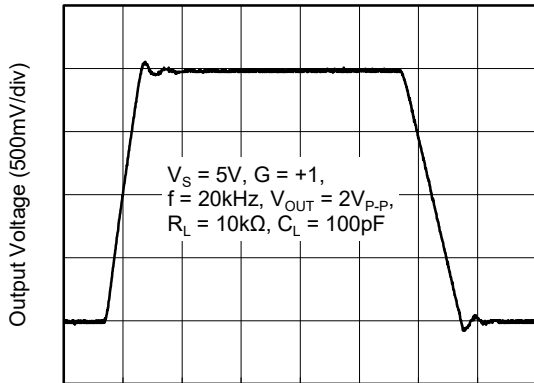

Time (5µs/div)

Small-Signal Step Response

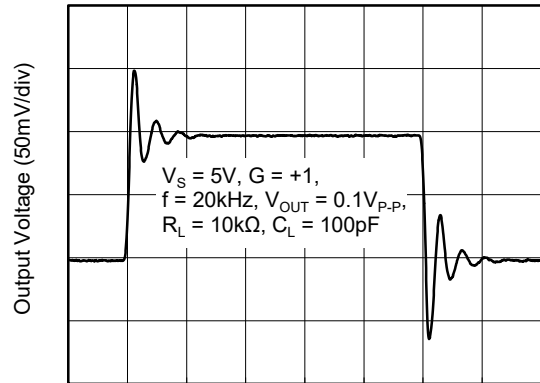

Time (5µs/div)

Large-Signal Step Response

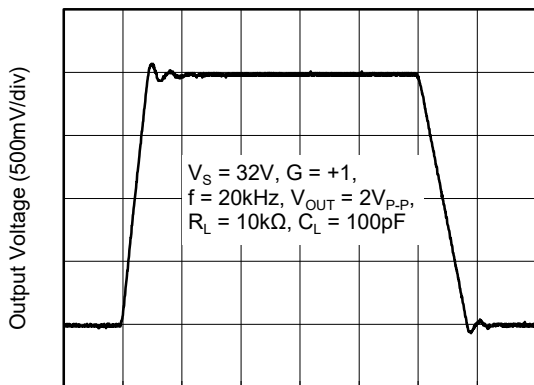

Time (5µs/div)

Small-Signal Step Response

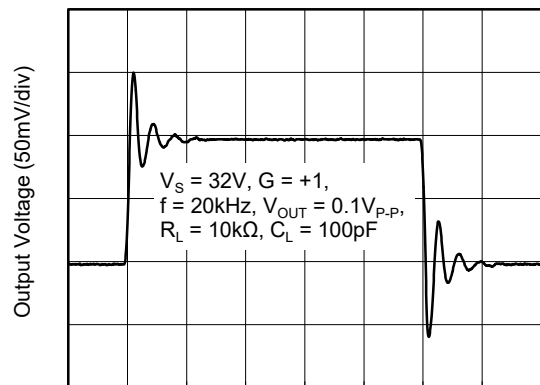

Time (5µs/div)

Turn-On Time

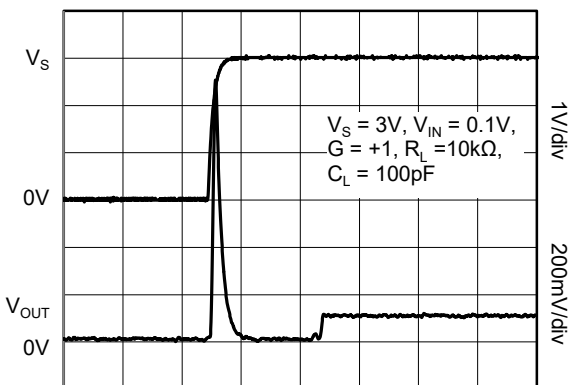

Time (20µs/div)

Turn-On Time

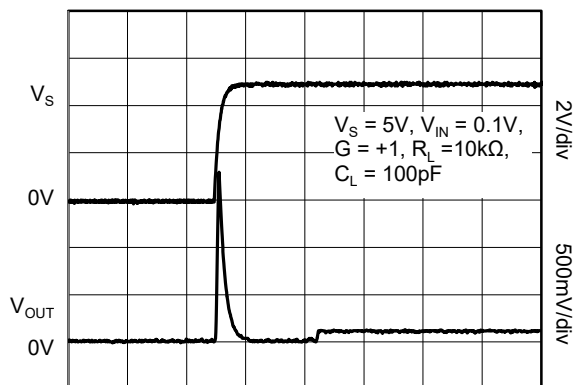

Time (20µs/div)

TYPICAL PERFORMANCE CHARACTERISTICS (continued)

At $T_A = +25^\circ\text{C}$, $V_{CM} = V_S/2$, unless otherwise noted.

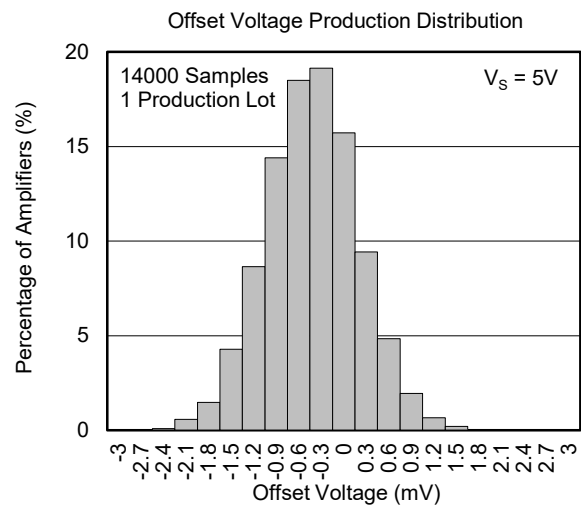
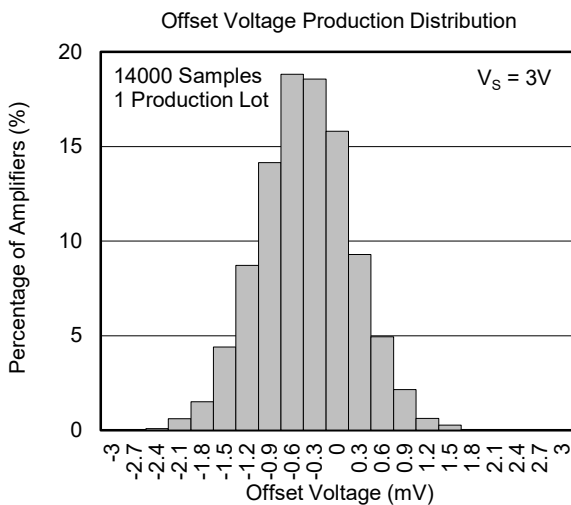
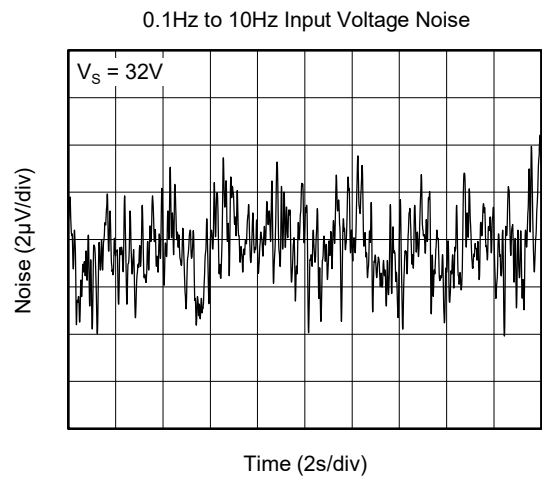
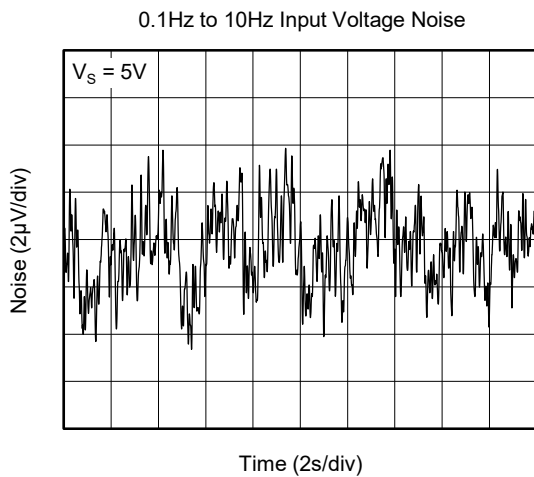
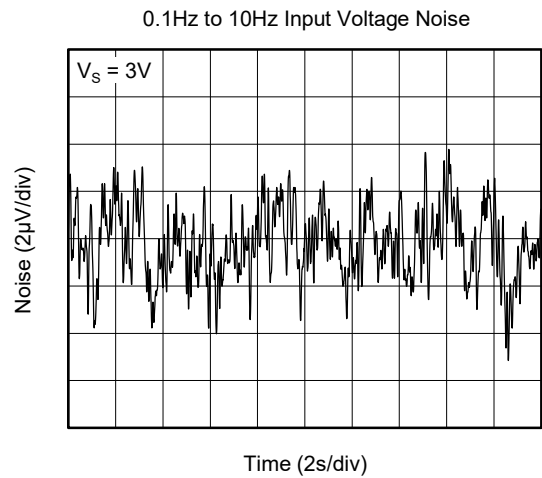
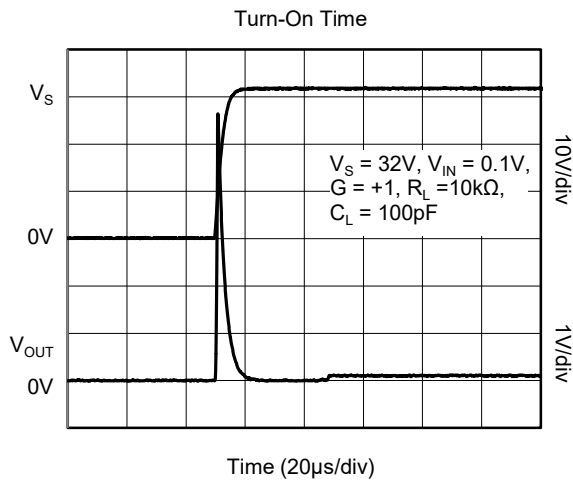

TYPICAL PERFORMANCE CHARACTERISTICS (continued)

At $T_A = +25^\circ\text{C}$, $V_{CM} = V_S/2$, unless otherwise noted.

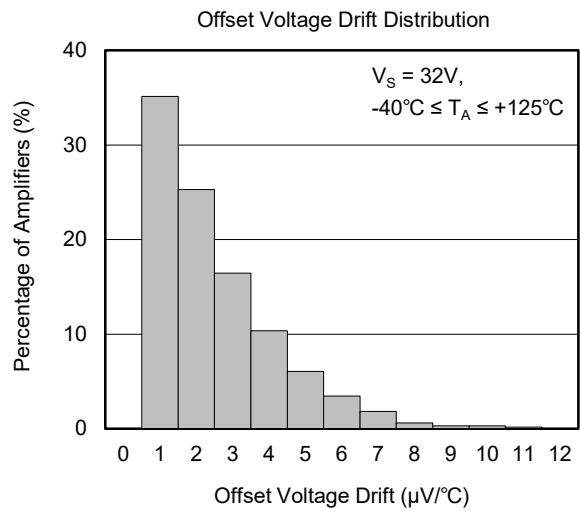
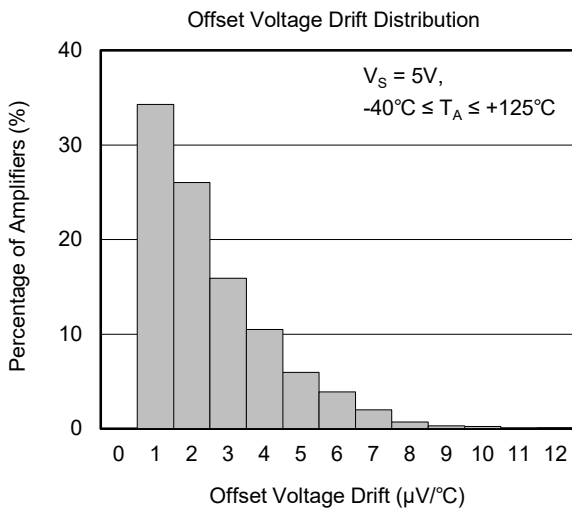
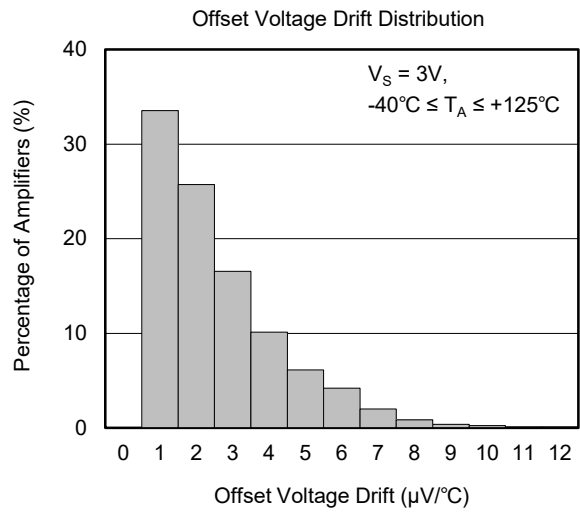
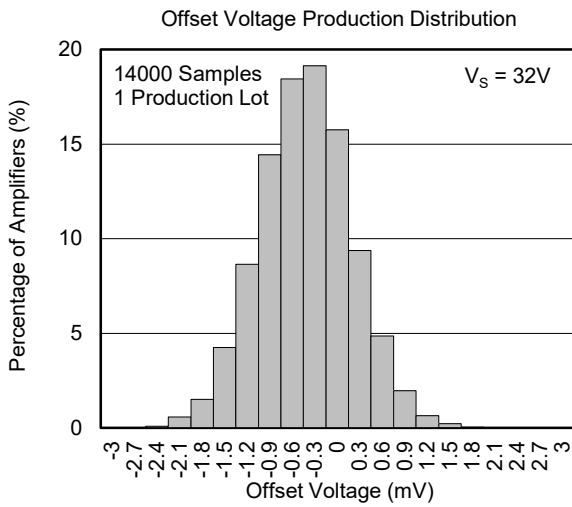

REVISION HISTORY

NOTE: Page numbers for previous revisions may differ from page numbers in the current version.

Changes from Original (JUNE 2019) to REV.A	Page
Changed from product preview to production data.....	All

PACKAGE OUTLINE DIMENSIONS

SOIC-14

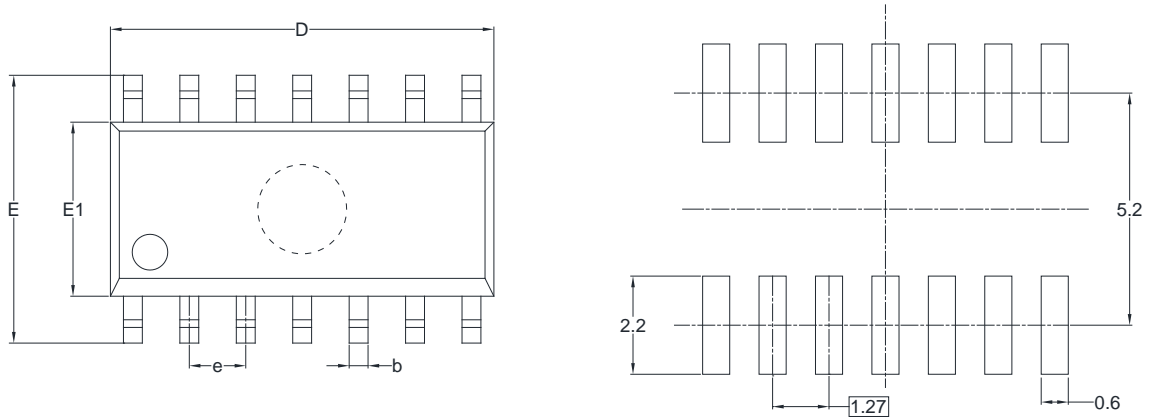

RECOMMENDED LAND PATTERN (Unit: mm)

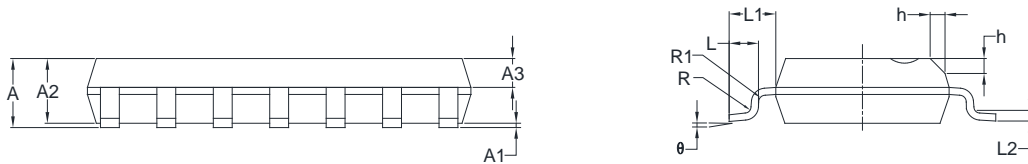

Symbol	Dimensions In Millimeters		Dimensions In Inches	
	MIN	MAX	MIN	MAX
A	1.35	1.75	0.053	0.069
A1	0.10	0.25	0.004	0.010
A2	1.25	1.65	0.049	0.065
A3	0.55	0.75	0.022	0.030
b	0.36	0.49	0.014	0.019
D	8.53	8.73	0.336	0.344
E	5.80	6.20	0.228	0.244
E1	3.80	4.00	0.150	0.157
e	1.27 BSC		0.050 BSC	
L	0.45	0.80	0.018	0.032
L1	1.04 REF		0.040 REF	
L2	0.25 BSC		0.01 BSC	
R	0.07		0.003	
R1	0.07		0.003	
h	0.30	0.50	0.012	0.020
θ	0°	8°	0°	8°

NOTES:

1. Body dimensions do not include mode flash or protrusion.
2. This drawing is subject to change without notice.

PACKAGE INFORMATION

TAPE AND REEL INFORMATION

REEL DIMENSIONS

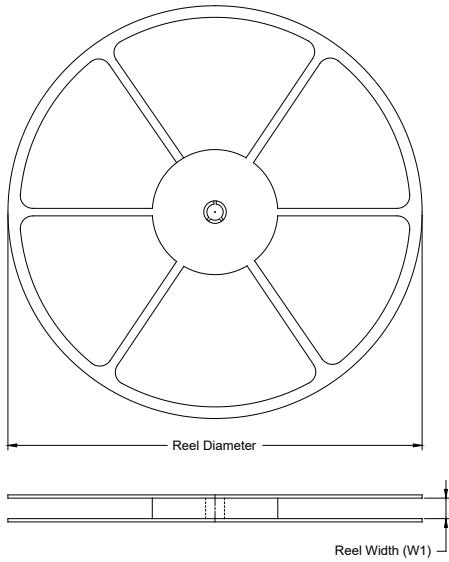

TAPE DIMENSIONS



NOTE: The picture is only for reference. Please make the object as the standard.

KEY PARAMETER LIST OF TAPE AND REEL

Package Type	Reel Diameter	Reel Width W1 (mm)	A0 (mm)	B0 (mm)	K0 (mm)	P0 (mm)	P1 (mm)	P2 (mm)	W (mm)	Pin1 Quadrant
SOIC-14	13"	16.4	6.60	9.30	2.10	4.0	8.0	2.0	16.0	Q1

000001

PACKAGE INFORMATION

CARTON BOX DIMENSIONS



NOTE: The picture is only for reference. Please make the object as the standard.

KEY PARAMETER LIST OF CARTON BOX

Reel Type	Length (mm)	Width (mm)	Height (mm)	Pizza/Carton
13"	386	280	370	5

DD0002

单击下面可查看定价，库存，交付和生命周期等信息

[>>SGMICRO\(圣邦微电子\)](#)