



SGM8521/SGM8522/SGM8524 150kHz, 5.5 μ A, Rail-to-Rail I/O, CMOS Operational Amplifiers

GENERAL DESCRIPTION

The SGM8521 (single), SGM8522 (dual) and SGM8524 (quad) are low cost, voltage feedback amplifiers. These devices can operate from 2.1V to 5.5V single supply, while consuming only 5.5 μ A quiescent current per amplifier. They provide rail-to-rail input with a wide input common mode voltage range and rail-to-rail output voltage swing. This feature makes SGM8521/2/4 appropriate for buffering ASIC.

The SGM8521/2/4 offer a gain-bandwidth product of 150kHz and an ultra-low input bias current of 3pA. They are well suited for piezoelectric sensors, integrators and photodiode amplifiers.

The SGM8521/2/4 are designed into a wide range of applications, such as battery-powered instrumentation, safety monitoring, portable systems, and transducer interface circuits in low power systems.

The SGM8521 is available in Green SOT-23-5 and SOIC-8 packages. The SGM8522 is available in Green SOIC-8 and MSOP-8 packages. The SGM8524 is available in Green SOIC-14 and TSSOP-14 packages. They are specified over the extended -40 $^{\circ}$ C to +125 $^{\circ}$ C temperature range.

FEATURES

- **Low Cost**
- **Input Offset Voltage: 3.5mV (MAX)**
- **Unity-Gain Stable**
- **Gain-Bandwidth Product: 150kHz**
- **Rail-to-Rail Input and Output**
- **Supply Voltage Range: 2.1V to 5.5V**
- **Input Voltage Range:**
-0.1V to 5.6V with $V_S = 5.5V$
- **Low Supply Current: 5.5 μ A/Amplifier**
- **-40 $^{\circ}$ C to +125 $^{\circ}$ C Operating Temperature Range**
- **Small Packaging:**
SGM8521 Available in Green SOIC-8 and SOT-23-5 Packages
SGM8522 Available in Green SOIC-8 and MSOP-8 Packages
SGM8524 Available in Green SOIC-14 and TSSOP-14 Packages

APPLICATIONS

ASIC Input or Output Amplifiers
Piezoelectric Transducer Amplifiers
Battery-Powered Equipment
Portable Systems
Sensor Interfaces
Medical Instrumentation
Mobile Communications
Audio Outputs
Smoke Detectors
Mobile Telephones
Notebook PCs
PCMCIA Cards

PACKAGE/ORDERING INFORMATION

MODEL	PACKAGE DESCRIPTION	SPECIFIED TEMPERATURE RANGE	ORDERING NUMBER	PACKAGE MARKING	PACKING OPTION
SGM8521	SOT-23-5	-40°C to +125°C	SGM8521XN5/TR	8521	Tape and Reel, 3000
	SOIC-8	-40°C to +125°C	SGM8521XS/TR	SGM8521XS XXXXX	Tape and Reel, 2500
SGM8522	SOIC-8	-40°C to +125°C	SGM8522XS/TR	SGM8522XS XXXXX	Tape and Reel, 2500
	MSOP-8	-40°C to +125°C	SGM8522XMS/TR	SGM8522 XMS XXXXX	Tape and Reel, 3000
SGM8524	SOIC-14	-40°C to +125°C	SGM8524XS14/TR	SGM8524XS14 XXXXX	Tape and Reel, 2500
	TSSOP-14	-40°C to +125°C	SGM8524XTS14/TR	SGM8524 XTS14 XXXXX	Tape and Reel, 3000

MARKING INFORMATION

NOTE: XXXXX = Date Code and Vendor Code.

XXXXX

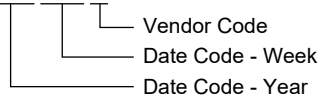

Green (RoHS & HSF): SG Micro Corp defines "Green" to mean Pb-Free (RoHS compatible) and free of halogen substances. If you have additional comments or questions, please contact your SGMICRO representative directly.

ABSOLUTE MAXIMUM RATINGS

- Supply Voltage, +Vs to -Vs6V
- Input Common Mode Voltage Range
..... (-Vs) - 0.3V to (+Vs) + 0.3V
- Package Thermal Resistance @ TA = +25°C
- SOT-23-5, θJA 190°C/W
- SOIC-8, θJA 125°C/W
- MSOP-8, θJA 216°C/W
- Junction Temperature+150°C
- Storage Temperature Range-65°C to +150°C
- Lead Temperature (Soldering, 10s)+260°C
- ESD Susceptibility
- HBM 4000V
- MM 400V

RECOMMENDED OPERATING CONDITIONS

- Operating Temperature Range-40°C to +125°C

OVERSTRESS CAUTION

Stresses beyond those listed in Absolute Maximum Ratings may cause permanent damage to the device. Exposure to absolute maximum rating conditions for extended periods may affect reliability. Functional operation of the device at any conditions beyond those indicated in the Recommended Operating Conditions section is not implied.

ESD SENSITIVITY CAUTION

This integrated circuit can be damaged if ESD protections are not considered carefully. SGMICRO recommends that all integrated circuits be handled with appropriate precautions. Failure to observe proper handling and installation procedures can cause damage. ESD damage can range from subtle performance degradation to complete device failure. Precision integrated circuits may be more susceptible to damage because even small parametric changes could cause the device not to meet the published specifications.

DISCLAIMER

SG Micro Corp reserves the right to make any change in circuit design, or specifications without prior notice.

PIN CONFIGURATIONS

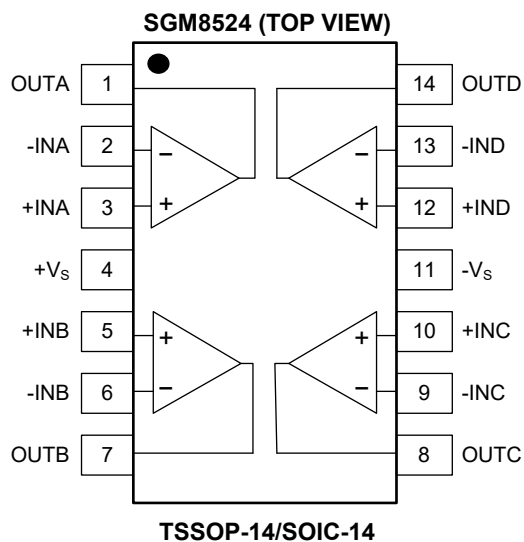
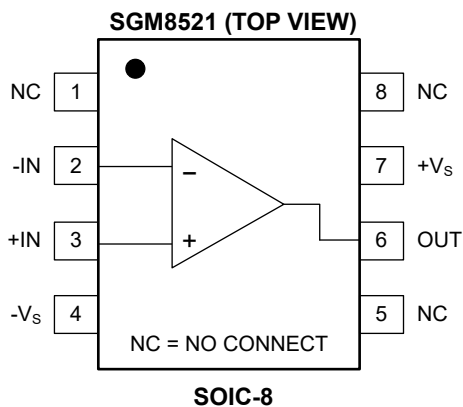
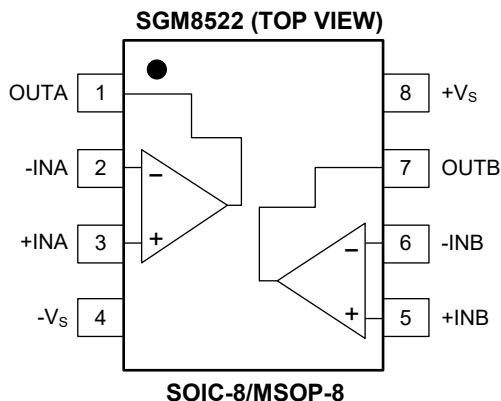
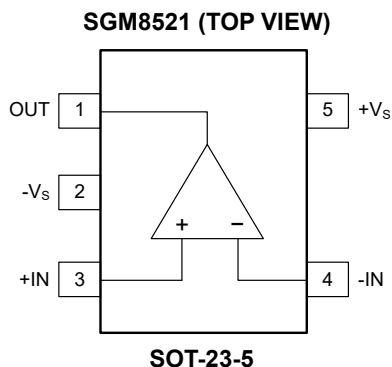

ELECTRICAL CHARACTERISTICS

(At T_A = +25°C, V_S = 5V, R_L = 500kΩ connected to V_S/2 and V_{OUT} = V_S/2, unless otherwise noted.)

PARAMETER	SYMBOL	CONDITIONS	MIN	TYP	MAX	UNITS
Input Offset Voltage	V _{OS}			1	3.5	mV
Input Bias Current	I _B			3		pA
Input Offset Current	I _{OS}			3		pA
Input Offset Voltage Drift	ΔV _{OS} /ΔT			2		μV/°C
Quiescent Current/Amplifier	I _Q			5.5		μA
Open-Loop Voltage Gain	A _{OL}	V _{OUT} = 0.015V to 4.985V, R _L = 500kΩ	90	110		dB
		V _{OUT} = 0.1V to 4.9V, R _L = 100kΩ	88	108		
Common Mode Rejection Ratio	CMRR	V _S = 5.5V, -0.1V < V _{CM} < 5.6V	60	87		dB
		V _S = 5.5V, -0.1V < V _{CM} < 4V	70	114		
Power Supply Rejection Ratio	PSRR	V _S = 2.5V to 5.5V, V _{CM} = 0.5V	65	94		dB
Output Current	I _{SOURCE}	R _L = 10Ω to V _S /2	61	87		mA
	I _{SINK}		60	76		
Output Voltage Swing	V _{OH}		4.990	4.997		V
	V _{OL}			0.005	0.010	
Gain-Bandwidth Product	GBP			150		kHz
Slew Rate	SR	R _L = 100kΩ		0.05		V/μs
Input Voltage Noise Density	e _n	f = 1kHz		85		nV/√Hz
		f = 10kHz		44		

TYPICAL PERFORMANCE CHARACTERISTICS

At $T_A = +25^\circ\text{C}$, $V_S = 5\text{V}$ and $R_L = 500\text{k}\Omega$ connected to $V_S/2$, unless otherwise noted.

Small-Signal Step Response

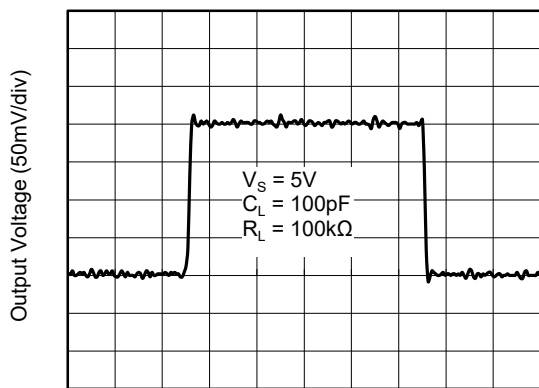

Time (50μs/div)

Large-Signal Step Response

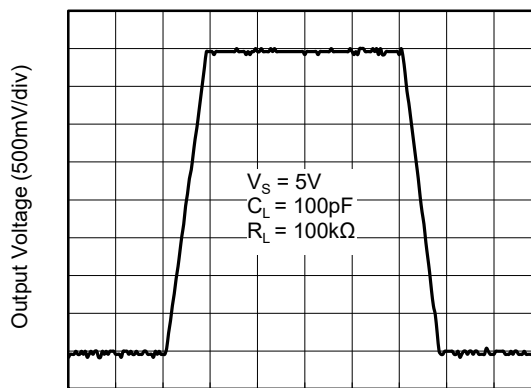

Time (100μs/div)

CMRR and PSRR vs. Frequency

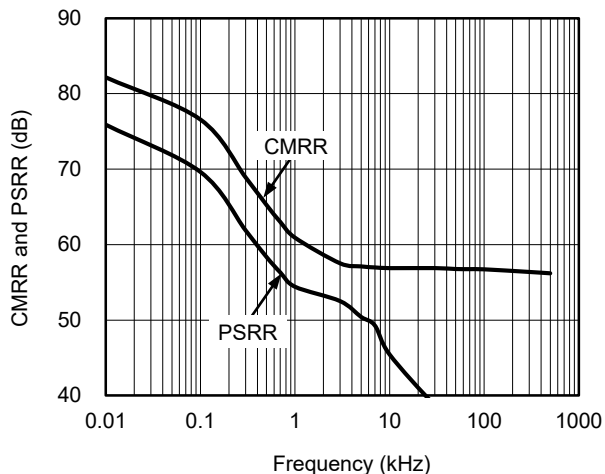

Maximum Output Voltage vs. Frequency

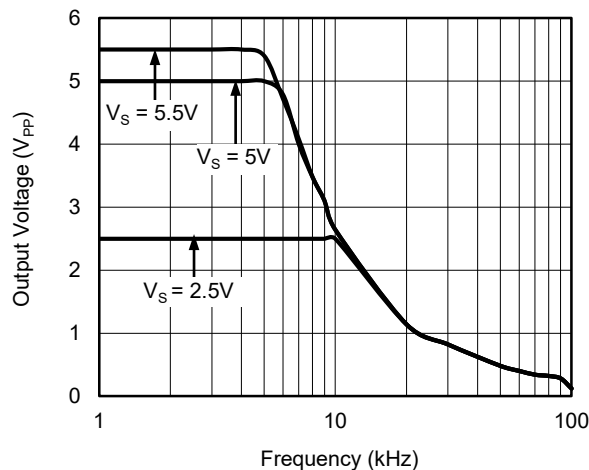

Small-Signal Overshoot vs. Capacitive Load

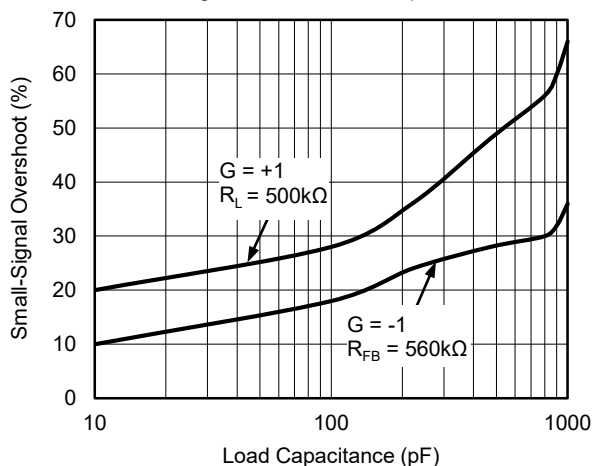

Open-Loop Gain and Phase vs. Frequency

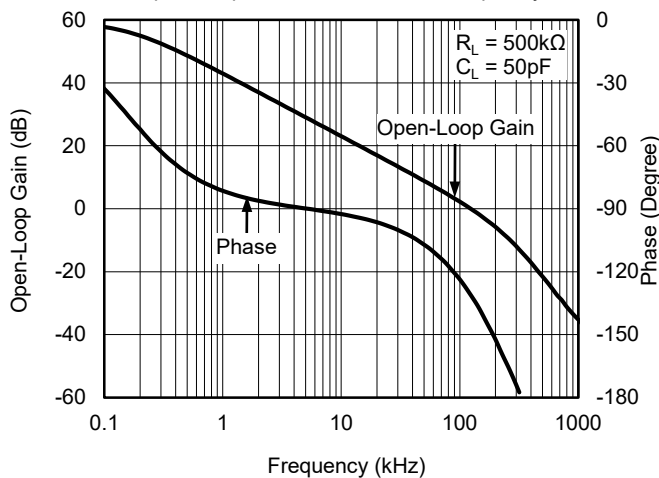

TYPICAL PERFORMANCE CHARACTERISTICS (continued)

At $T_A = +25^\circ\text{C}$, $V_S = 5\text{V}$ and $R_L = 500\text{k}\Omega$ connected to $V_S/2$, unless otherwise noted.

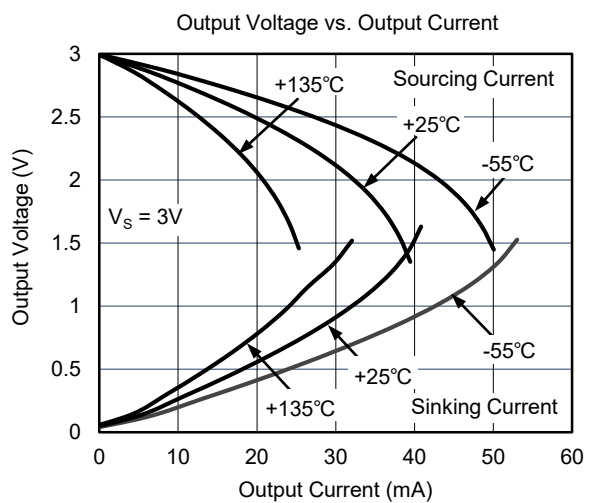
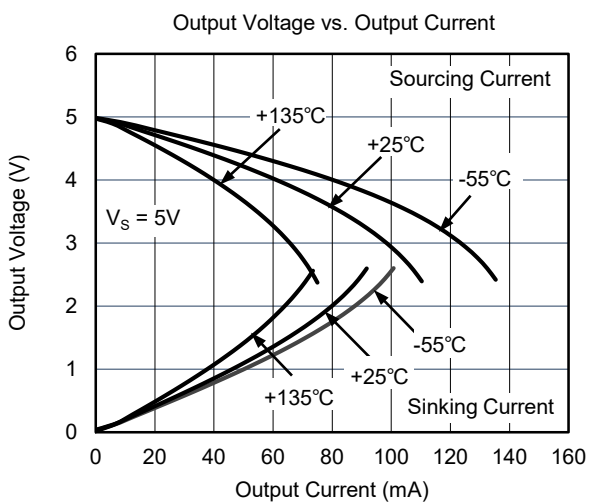
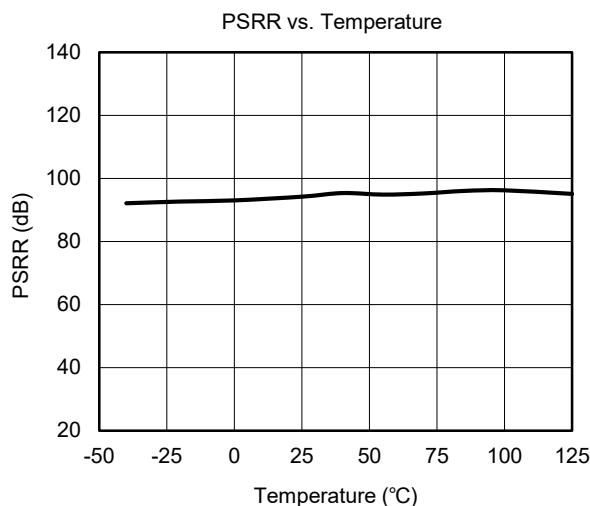
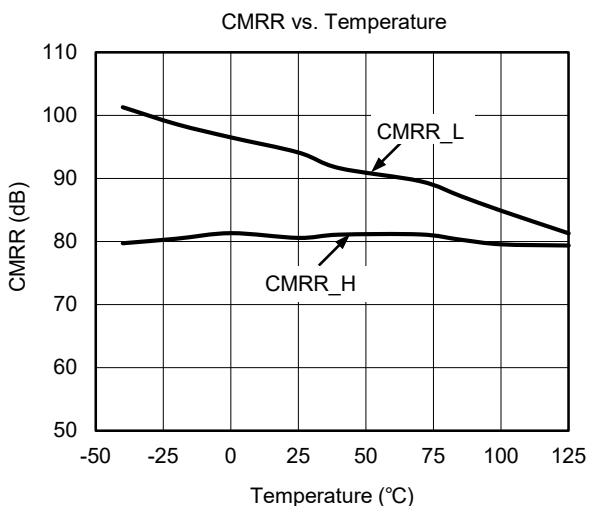
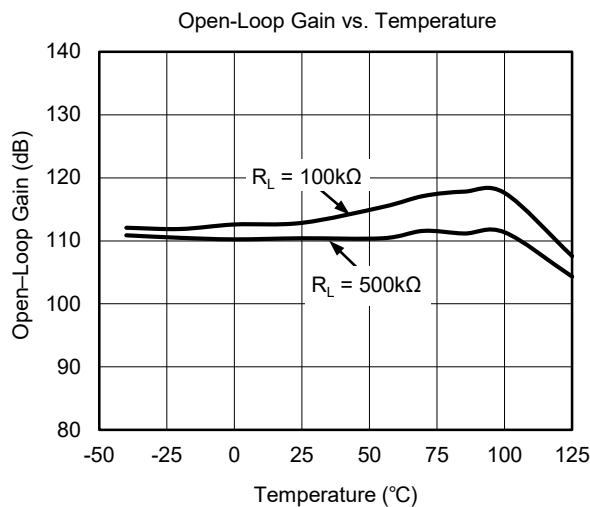
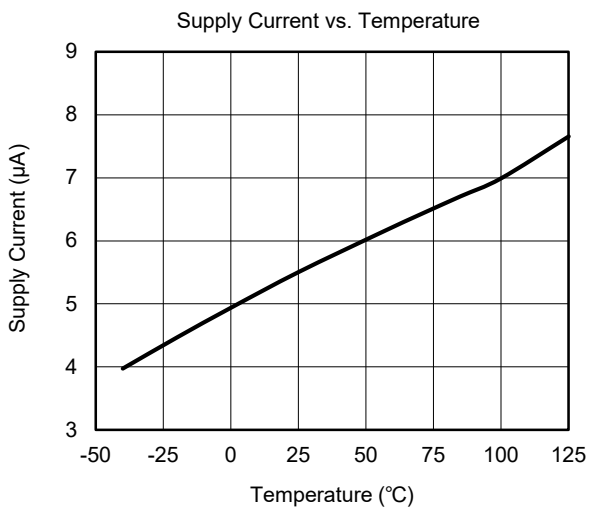

TYPICAL PERFORMANCE CHARACTERISTICS (continued)

At $T_A = +25^\circ\text{C}$, $V_S = 5\text{V}$ and $R_L = 500\text{k}\Omega$ connected to $V_S/2$, unless otherwise noted.

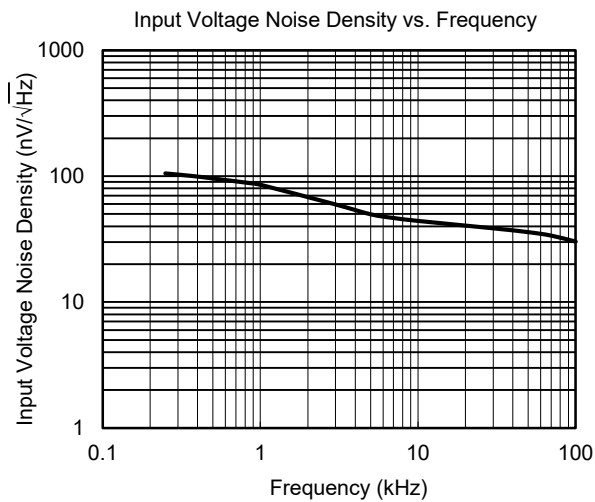
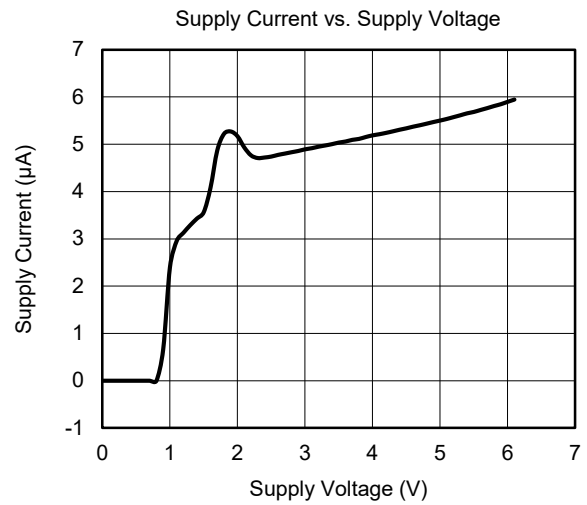
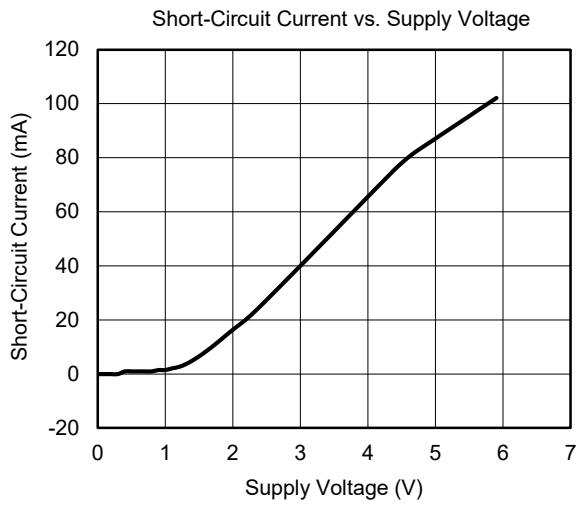

REVISION HISTORY

NOTE: Page numbers for previous revisions may differ from page numbers in the current version.

NOVEMBER 2018 – REV.C.4 to REV.D

Changed Open-Loop Gain and Phase vs. Frequency..... 6

JULY 2017 – REV.C.3 to REV.C.4

Added Open-Loop Gain and Phase vs. Frequency..... 6

JANUARY 2017 – REV.C.2 to REV.C.3

Changed Electrical Characteristics section 4

Updated SOIC-14 and TSSOP-14 packages 13, 14

Updated Tape and Reel Information section 15

APRIL 2013 – REV.C.1 to REV.C.2

Changed Electrical Characteristics section 3

Changed Input Voltage Noise Density vs. Frequency..... 4

NOVEMBER 2012 – REV.C to REV.C.1

Added SGM8524 All

PACKAGE INFORMATION

PACKAGE OUTLINE DIMENSIONS

SOT-23-5

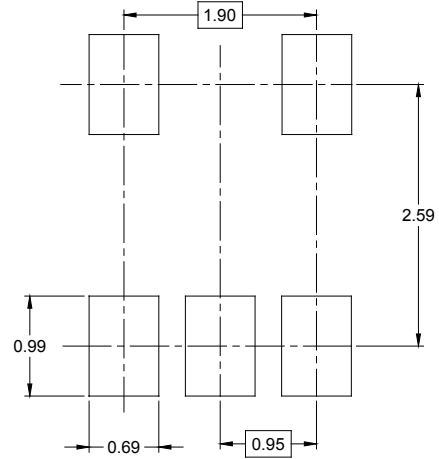
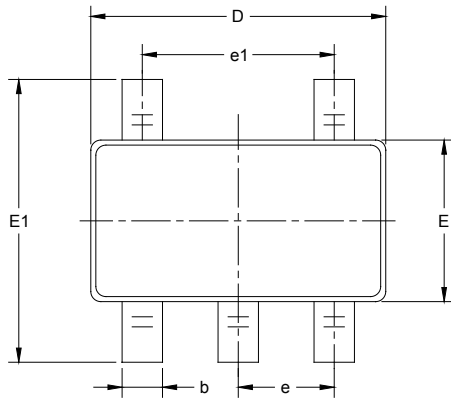

RECOMMENDED LAND PATTERN (Unit: mm)

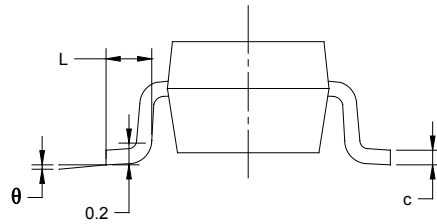

Symbol	Dimensions In Millimeters		Dimensions In Inches	
	MIN	MAX	MIN	MAX
A	1.050	1.250	0.041	0.049
A1	0.000	0.100	0.000	0.004
A2	1.050	1.150	0.041	0.045
b	0.300	0.500	0.012	0.020
c	0.100	0.200	0.004	0.008
D	2.820	3.020	0.111	0.119
E	1.500	1.700	0.059	0.067
E1	2.650	2.950	0.104	0.116
e	0.950 BSC		0.037 BSC	
e1	1.900 BSC		0.075 BSC	
L	0.300	0.600	0.012	0.024
θ	0°	8°	0°	8°

PACKAGE OUTLINE DIMENSIONS

SOIC-8

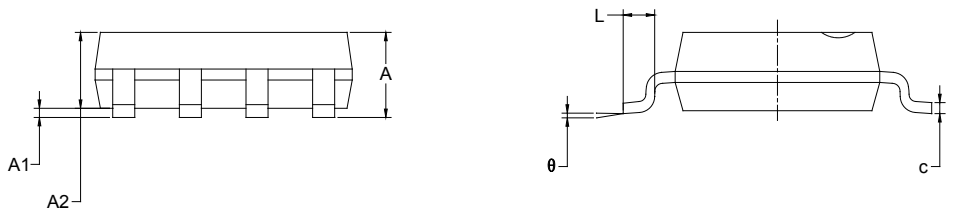
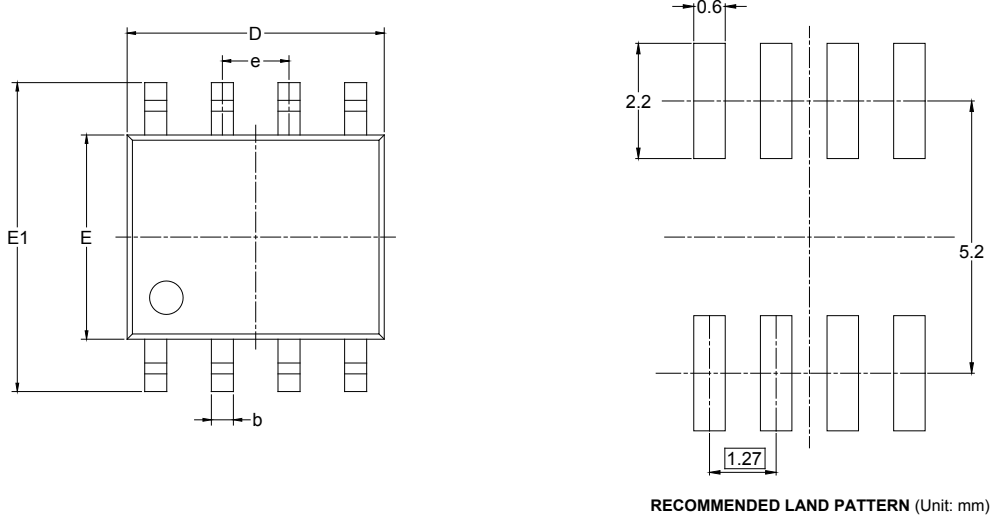

Symbol	Dimensions In Millimeters		Dimensions In Inches	
	MIN	MAX	MIN	MAX
A	1.350	1.750	0.053	0.069
A1	0.100	0.250	0.004	0.010
A2	1.350	1.550	0.053	0.061
b	0.330	0.510	0.013	0.020
c	0.170	0.250	0.006	0.010
D	4.700	5.100	0.185	0.200
E	3.800	4.000	0.150	0.157
E1	5.800	6.200	0.228	0.244
e	1.27 BSC		0.050 BSC	
L	0.400	1.270	0.016	0.050
θ	0°	8°	0°	8°

PACKAGE OUTLINE DIMENSIONS

MSOP-8

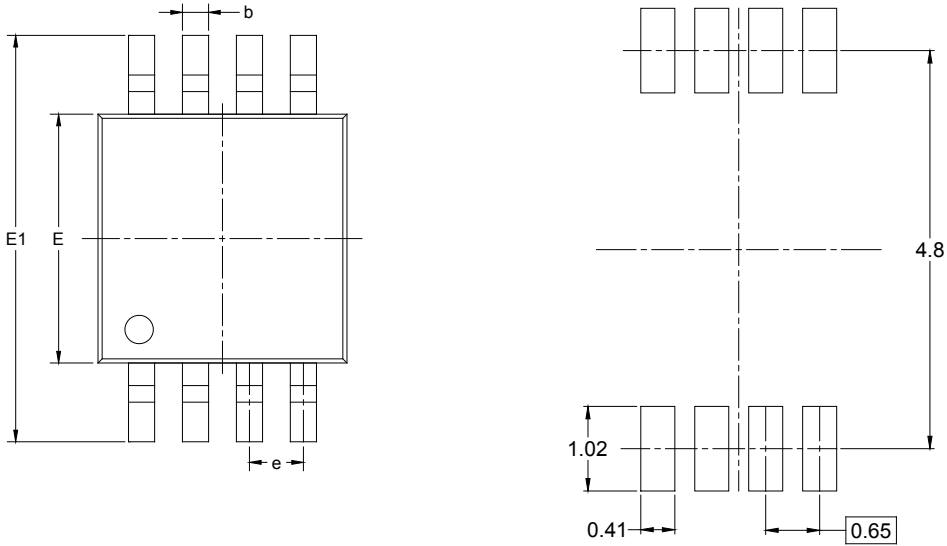

RECOMMENDED LAND PATTERN (Unit: mm)

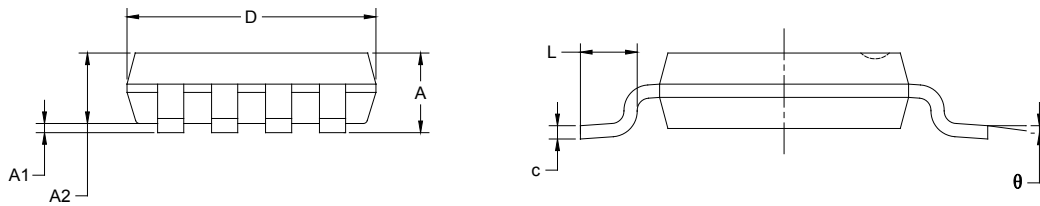

Symbol	Dimensions In Millimeters		Dimensions In Inches	
	MIN	MAX	MIN	MAX
A	0.820	1.100	0.032	0.043
A1	0.020	0.150	0.001	0.006
A2	0.750	0.950	0.030	0.037
b	0.250	0.380	0.010	0.015
c	0.090	0.230	0.004	0.009
D	2.900	3.100	0.114	0.122
E	2.900	3.100	0.114	0.122
E1	4.750	5.050	0.187	0.199
e	0.650 BSC		0.026 BSC	
L	0.400	0.800	0.016	0.031
θ	0°	6°	0°	6°

PACKAGE INFORMATION

PACKAGE OUTLINE DIMENSIONS

SOIC-14

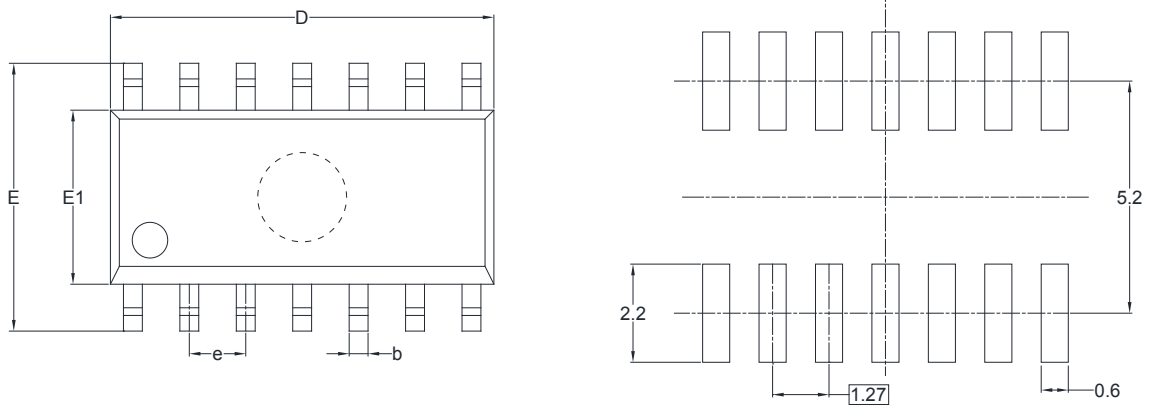

RECOMMENDED LAND PATTERN (Unit: mm)

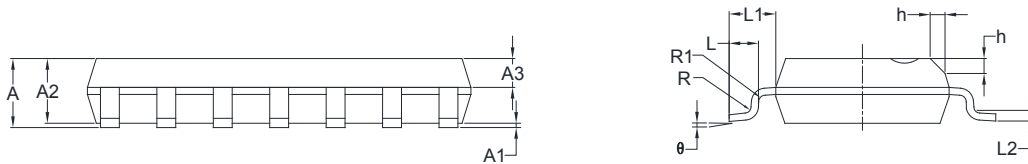

Symbol	Dimensions In Millimeters		Dimensions In Inches	
	MIN	MAX	MIN	MAX
A	1.35	1.75	0.053	0.069
A1	0.10	0.25	0.004	0.010
A2	1.25	1.65	0.049	0.065
A3	0.55	0.75	0.022	0.030
b	0.36	0.49	0.014	0.019
D	8.53	8.73	0.336	0.344
E	5.80	6.20	0.228	0.244
E1	3.80	4.00	0.150	0.157
e	1.27 BSC		0.050 BSC	
L	0.45	0.80	0.018	0.032
L1	1.04 REF		0.040 REF	
L2	0.25 BSC		0.01 BSC	
R	0.07		0.003	
R1	0.07		0.003	
h	0.30	0.50	0.012	0.020
θ	0°	8°	0°	8°

PACKAGE INFORMATION

PACKAGE OUTLINE DIMENSIONS

TSSOP-14

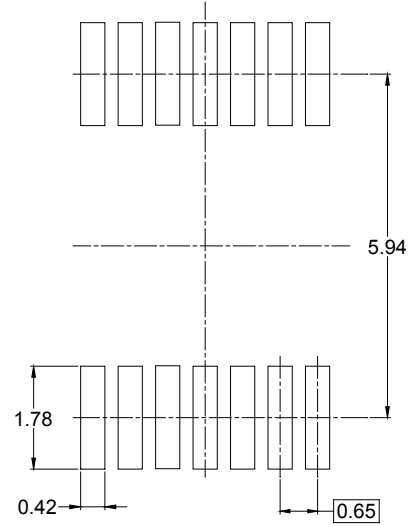
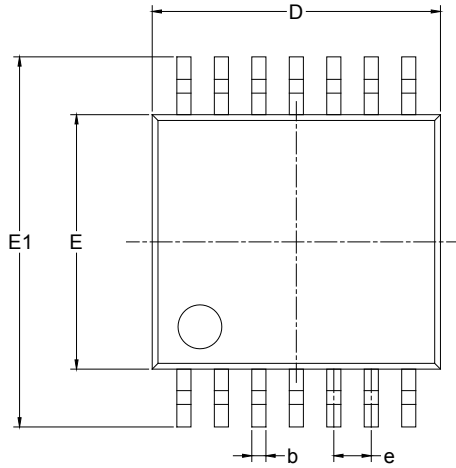

RECOMMENDED LAND PATTERN (Unit: mm)

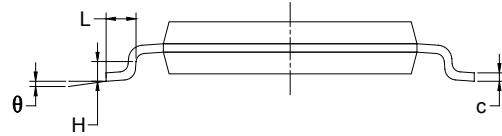
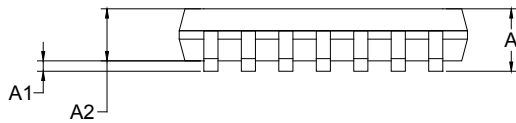

Symbol	Dimensions In Millimeters		Dimensions In Inches	
	MIN	MAX	MIN	MAX
A		1.200		0.047
A1	0.050	0.150	0.002	0.006
A2	0.800	1.050	0.031	0.041
b	0.190	0.300	0.007	0.012
c	0.090	0.200	0.004	0.008
D	4.860	5.100	0.191	0.201
E	4.300	4.500	0.169	0.177
E1	6.250	6.550	0.246	0.258
e	0.650 BSC		0.026 BSC	
L	0.500	0.700	0.02	0.028
H	0.25 TYP		0.01 TYP	
θ	1°	7°	1°	7°

PACKAGE INFORMATION

TAPE AND REEL INFORMATION

REEL DIMENSIONS



TAPE DIMENSIONS



NOTE: The picture is only for reference. Please make the object as the standard.

KEY PARAMETER LIST OF TAPE AND REEL

Package Type	Reel Diameter	Reel Width W1 (mm)	A0 (mm)	B0 (mm)	K0 (mm)	P0 (mm)	P1 (mm)	P2 (mm)	W (mm)	Pin1 Quadrant
SOT-23-5	7"	9.5	3.20	3.20	1.40	4.0	4.0	2.0	8.0	Q3
SOIC-8	13"	12.4	6.40	5.40	2.10	4.0	8.0	2.0	12.0	Q1
MSOP-8	13"	12.4	5.20	3.30	1.50	4.0	8.0	2.0	12.0	Q1
SOIC-14	13"	16.4	6.60	9.30	2.10	4.0	8.0	2.0	16.0	Q1
TSSOP-14	13"	12.4	6.95	5.60	1.20	4.0	8.0	2.0	12.0	Q1

D20001

PACKAGE INFORMATION

CARTON BOX DIMENSIONS



NOTE: The picture is only for reference. Please make the object as the standard.

KEY PARAMETER LIST OF CARTON BOX

Reel Type	Length (mm)	Width (mm)	Height (mm)	Pizza/Carton
7" (Option)	368	227	224	8
7"	442	410	224	18
13"	386	280	370	5

DD0002

单击下面可查看定价，库存，交付和生命周期等信息

[>>SGMICRO\(圣邦微电子\)](#)