



SGM5348-12

8 Channels, 12-Bit Digital-to-Analog Converter with Output Operational Amplifier

GENERAL DESCRIPTION

The SGM5348-12 features 8 channels of digital-to-analog converter (DAC) with output amplifiers. The output amplifier provides high current drive capability. The digital data is sent via SPI interface, and cascaded connections can be used. The SGM5348-12 provides daisy-chain capability, which can update multiple SGM5348-12s simultaneously by using a single serial interface.

The SGM5348-12 has two references (one reference input for channel 1 to channel 4, and the other reference for channel 5 to channel 8). Each reference voltage operates independently from a 0.5V to V_{CC} supply, providing a dynamic range of output as broad as possible. The SGM5348-12 contains a 16-bit shift register, which controls the operation mode, the power-down condition and the register/output value of the DAC channels. All 8 channels DAC outputs can be updated simultaneously or separately.

The SGM5348-12 incorporates a power-on reset circuit that ensures the DAC outputs power to 0V and remains 0V until a valid write occurs. The SGM5348-12 provides a power-down function that allows each DAC to be separately powered with three different output terminations. When all the DAC channels are powered down, the current consumption of the device reduces to less than 1.5 μ W at 3V and less than 3 μ W at 5V.

The SGM5348-12 is available in Green TSSOP-16 and TQFN-3 \times 3-16L packages. It operates over the extended industrial temperature range of -40 $^{\circ}$ C to +125 $^{\circ}$ C.

FEATURES

- **Low Power Consumption (0.5mW/CH)**
- **Integrating 8 Channels of 12-Bit DAC**
- **Built-In Rail-to-Rail Output Amplifier:**
 - **Sink/Source Current with Short Current Control**
- **Daisy-Chain Operation**
- **8 Channels Outputs Update Simultaneously**
- **Independent Channel Power-Down Function**
 - **0.6 μ A (TYP) I_{CC} for Power-Down Mode**
- **0.1% (TYP) Gain Error for All Channels**
- **Interface Sees No Quiescent Current when $V_{BUS} < V_{CC}$**
- **Power-On Reset: Output Reset to GND**
- **Serial Data Input: Up to 40MHz Operation**
- **TTL Compatible Input Logic Level**
- **Power Supply Voltage Range: 2.8V to 5.5V**
- **Double Reference Voltages Range: 0.5V to V_{CC}**
- **-40 $^{\circ}$ C to +125 $^{\circ}$ C Operating Temperature Range**
- **Available in Green TSSOP-16 and TQFN-3 \times 3-16L Packages**

APPLICATIONS

Battery Powered Equipment
Selectable Voltage and Current Sources
ADC Voltage Reference
Sensor Power Supply Voltage
Audio Signal Volumes Control

8 Channels, 12-Bit Digital-to-Analog Converter with Output Operational Amplifier

SGM5348-12

PACKAGE/ORDERING INFORMATION

MODEL	PACKAGE DESCRIPTION	SPECIFIED TEMPERATURE RANGE	ORDERING NUMBER	PACKAGE MARKING	PACKING OPTION
SGM5348-12	TSSOP-16	-40°C to +125°C	SGM5348-12XTS16G/TR	SGMME3 XTS16 XXXXX	Tape and Reel, 4000
	TQFN-3×3-16L	-40°C to +125°C	SGM5348-12XTQ16G/TR	CEBTQ XXXXX	Tape and Reel, 4000

MARKING INFORMATION

NOTE: XXXXX = Date Code, Trace Code and Vendor Code.

XXXXX

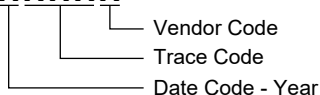

Green (RoHS & HSF): SG Micro Corp defines "Green" to mean Pb-Free (RoHS compatible) and free of halogen substances. If you have additional comments or questions, please contact your SGMICRO representative directly.

ABSOLUTE MAXIMUM RATINGS

Power Supply Voltage Range, V_{CC} -0.3V to 6.5V
 Input Voltage Range, V_{IN} -0.3V to $V_{CC} + 0.3V$
 Output Voltage Range, V_{OUT} -0.3V to $V_{CC} + 0.3V$
 Input Current10mA
 Package Input Current30mA
 Package Thermal Resistance
 TSSOP-16 120°C/W
 TQFN-3×3-16L 58°C/W
 Junction Temperature+150°C
 Storage Temperature Range -65°C to +150°C
 Lead Temperature (Soldering, 10s)+260°C
 ESD Susceptibility
 HBM4000V
 CDM1000V

RECOMMENDED OPERATING CONDITIONS

Power Supply Voltage Range, V_{CC} 2.8V to 5.5V
 Reference Voltage, V_{REF1} , V_{REF2} 0.5V to V_{CC}
 Oscillation Limited Output Capacitance, C_{OL} 2nF (MAX)
 SCLK Frequency 40MHz (MAX)
 Operating Temperature Range -40°C to +125°C

OVERSTRESS CAUTION

Stresses beyond those listed in Absolute Maximum Ratings may cause permanent damage to the device. Exposure to absolute maximum rating conditions for extended periods may affect reliability. Functional operation of the device at any conditions beyond those indicated in the Recommended Operating Conditions section is not implied.

ESD SENSITIVITY CAUTION

This integrated circuit can be damaged if ESD protections are not considered carefully. SGMICRO recommends that all integrated circuits be handled with appropriate precautions. Failure to observe proper handling and installation procedures can cause damage. ESD damage can range from subtle performance degradation to complete device failure. Precision integrated circuits may be more susceptible to damage because even small parametric changes could cause the device not to meet the published specifications.

DISCLAIMER

SG Micro Corp reserves the right to make any change in circuit design, or specifications without prior notice.

PIN CONFIGURATIONS

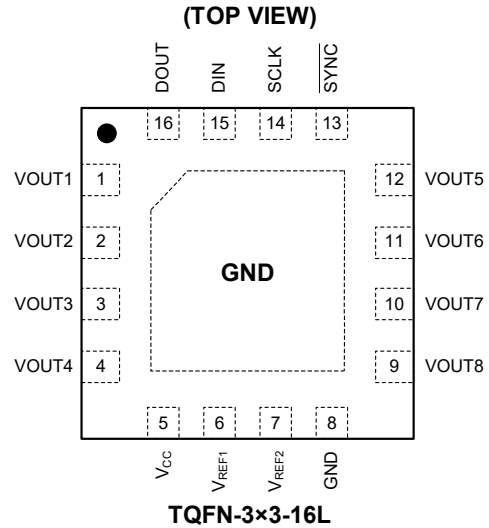
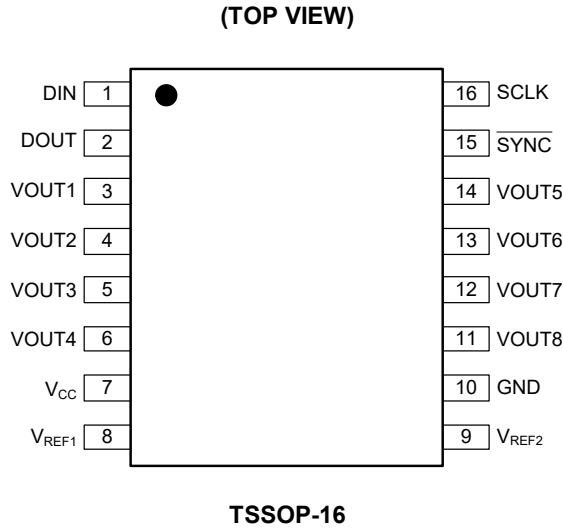

PIN DESCRIPTION

PIN		NAME	TYPE ⁽¹⁾	DESCRIPTION
TSSOP-16	TQFN-3x3-16L			
1	15	DIN	DI	Serial Data Input Pin. Data is clocked into the 16-bit input shift register on the falling edges of SCLK.
2	16	DOUT	DO	Serial Data Output Pin.
3	1	VOUT1	AO	Analog Output Voltage from CH1.
4	2	VOUT2	AO	Analog Output Voltage from CH2.
5	3	VOUT3	AO	Analog Output Voltage from CH3.
6	4	VOUT4	AO	Analog Output Voltage from CH4.
7	5	V _{CC}	P	Power Supply Pin. It must be decoupled to GND.
8	6	V _{REF1}	AI	Un-Buffered Reference Voltage Shared by Channels 1, 2, 3 and 4. It must be decoupled to GND.
9	7	V _{REF2}	AI	Un-Buffered Reference Voltage Shared by Channels 5, 6, 7 and 8. It must be decoupled to GND.
10	8	GND	G	Ground.
11	9	VOUT8	AO	Analog Output Voltage from CH8.
12	10	VOUT7	AO	Analog Output Voltage from CH7.
13	11	VOUT6	AO	Analog Output Voltage from CH6.
14	12	VOUT5	AO	Analog Output Voltage from CH5.
15	13	$\overline{\text{SYNC}}$	DI	Frame Synchronization Input Pin. Active low. When this pin goes low, data is transferred into the input shift register on the falling edges of SCLK. After the 16 th falling edge of SCLK, the DAC is updated. If SYNC is brought high before this edge, the rising edge of SYNC acts as an interrupt and the write sequence is ignored by the DAC.
16	14	SCLK	DI	Serial Clock Input Pin.
-	Exposed Pad	GND	-	Exposed pad should be soldered to PCB board and connected to GND.

NOTE:

1. AI = Analog Input, AO = Analog Output, DI = Digital Input, DO = Digital Output, P = Power, G = Ground.

8 Channels, 12-Bit Digital-to-Analog Converter with Output Operational Amplifier

SGM5348-12

ELECTRICAL CHARACTERISTICS

($V_{CC} = 2.8V$ to $5.5V$, $T_A = -40^{\circ}C$ to $+125^{\circ}C$, $V_{REF1} = V_{REF2} = V_{CC}$, $C_L = 200pF$ to GND, input code range from 48 to 4047. Typical values are at $T_A = +25^{\circ}C$, unless otherwise noted.)

PARAMETER	CONDITIONS	MIN	TYP	MAX	UNITS
Analog DC Performance					
Resolution		12			Bit
INL ⁽¹⁾			3	11	LSB
DNL ⁽²⁾	Monotonicity guaranteed by design	-0.7		0.85	LSB
Offset			3	15	mV
Gain Error			0.1	0.45	%FSR
Offset Drift			10		$\mu V/^{\circ}C$
Gain Drift			2		ppmFS/ $^{\circ}C$
Zero Code Error	0 μA current load		3	15	mV
	200 μA current load		5		
	1mA current load		8		
Full Scale Error	0 μA current load		3	25	mV
	200 μA current load		6		
	1mA current load		20		
Zero Code Drift			5		$\mu V/^{\circ}C$
Full Scale Error Drift			5		$\mu V/^{\circ}C$
Analog AC Performance					
Output Settling Time	To 1LSB		7		μs
Slew Rate	$C_{LOAD} = 200pF$		0.9		V/ μs
Noise Density	Code = 0x800, f = 1kHz		30		nV/ \sqrt{Hz}
Noise	30kHz LPF		17		μV_{RMS}
Multiplying Bandwidth			300		kHz
Wake-Up Time	$C_{LOAD} = 200pF$		8		μs
Output Characteristics					
Output Resistance			0.3		Ω
Short Current	Sink		37		mA
	Source		37		
Continuous Current ⁽³⁾	$V_{CC} = 2.8V$		5		mA
	$V_{CC} = 5.5V$		10		
Maximum Capacitance Load			2		nF
Reference Characteristics					
V_{REF1}/V_{REF2}		0.5		V_{CC}	V
Input Impedance			50		k Ω
Digital Input Characteristics					
Input Current			0.1	1	μA
Input Low Voltage	$V_{CC} = 2.8V$ to $3.6V$			0.6	V
	$V_{CC} = 4.5V$ to $5.5V$			0.8	
Input High Voltage	$V_{CC} = 2.8V$ to $3.6V$	2.2			V
	$V_{CC} = 4.5V$ to $5.5V$	2.6			
Input Hysteresis			0.2		V

8 Channels, 12-Bit Digital-to-Analog Converter with Output Operational Amplifier

SGM5348-12

ELECTRICAL CHARACTERISTICS (continued)

($V_{CC} = 2.8V$ to $5.5V$, $T_A = -40^{\circ}C$ to $+125^{\circ}C$, $V_{REF1} = V_{REF2} = V_{CC}$, $C_L = 200pF$ to GND, input code range from 48 to 4047. Typical values are at $T_A = +25^{\circ}C$, unless otherwise noted.)

PARAMETER	CONDITIONS	MIN	TYP	MAX	UNITS
Power-On Reset					
Reset Level	MIN for minimum entry level, MAX for maximum release level	2.42	2.6	2.78	V
Hysteresis	Difference between reset release level and entry level		40		mV
Power Consumption					
Normal Operation Mode	$V_{CC} = 5V$		0.5	0.8	mA
	$V_{REF1} = V_{REF2} = 5V$		0.1	0.2	
Power-Down Mode	$V_{CC} = 5V$		0.6	7	μA
	$V_{REF1} = V_{REF2} = 5V$		0.01	1	

NOTES:

1. Nonlinearity error: The error of the I/O curve deviated from the ideal straight line between output voltages at "#030" and "#FCF".
2. Differential nonlinearity error: The error deviated from the ideal increment given when the digital value is incremented by one bit.
3. At $+125^{\circ}C$, please limit the output current of each channel to 5mA for maximum operating life time.

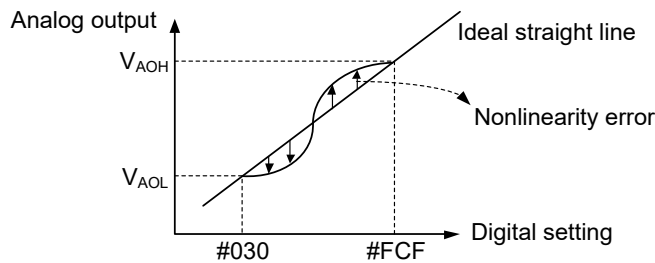

SGM5348-12

8 Channels, 12-Bit Digital-to-Analog Converter with Output Operational Amplifier

TIMING CHARACTERISTICS

($V_{CC} = 2.8V$ to $5.5V$, $T_A = +25^\circ C$, unless otherwise noted.)

PARAMETER	SYMBOL	CONDITIONS	MIN	TYP	MAX	UNITS
SCLK Frequency	f_{SCLK}				40	MHz
SCLK Cycle Time	$1/f_{SCLK}$		25	33		ns
SCLK High Time	t_{CH}		10			ns
SCLK Low Time	t_{CL}		10			ns
\overline{SYNC} Setup Time before SCLK Falling Edge	t_{SS}		3	10	$1/f_{SCLK} - 3$	ns
Data Setup Time before SCLK Falling Edge	$t_{DS}^{(1)}$		2.5			ns
Data Hold Time after SCLK Falling Edge	$t_{DH}^{(1)}$		2.5			ns
\overline{SYNC} Hold Time after the 16 th Falling Edge of SCLK	t_{SH}	$T_A = +25^\circ C$	0	3	$1/f_{SCLK} - 3$	ns
\overline{SYNC} High Time	t_{SYNC}		5			ns

NOTE: 1. When the internal LDO is enabled and $V_{BUS} = V_{CC}$, the minimum setup and hold times should be 4ns.

SGM5348-12 8 Channels, 12-Bit Digital-to-Analog Converter with Output Operational Amplifier

TYPICAL PERFORMANCE CHARACTERISTICS

T_A = +25°C, unless otherwise noted.

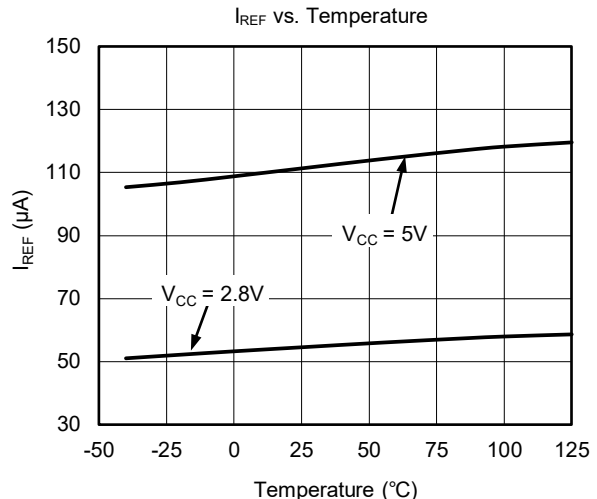
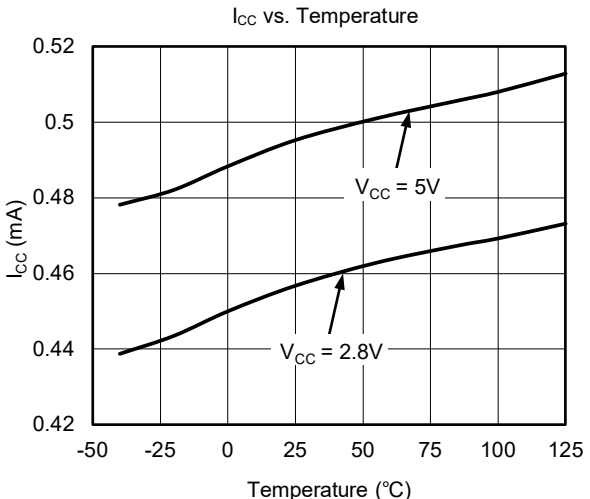
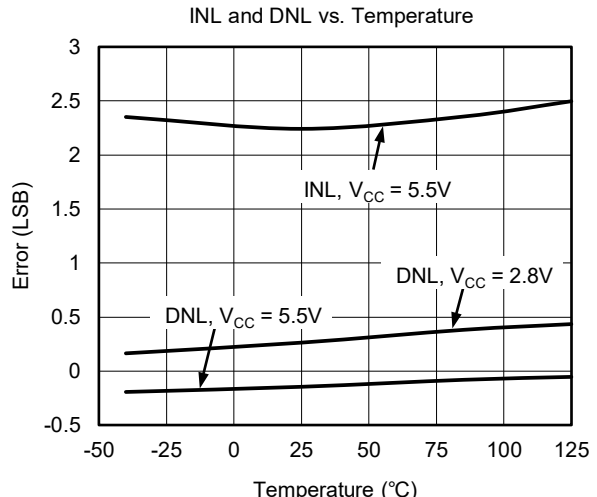
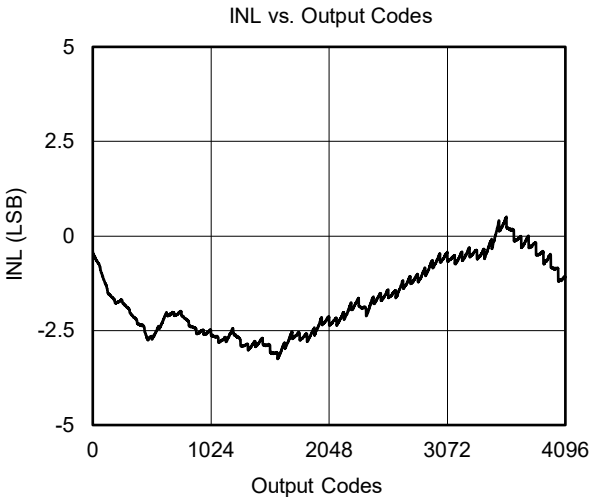
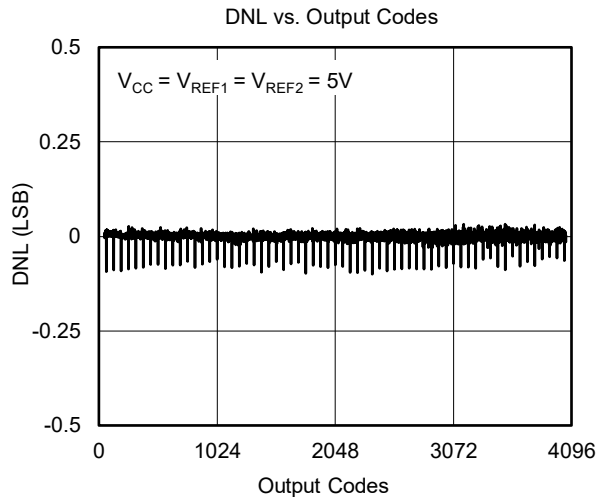
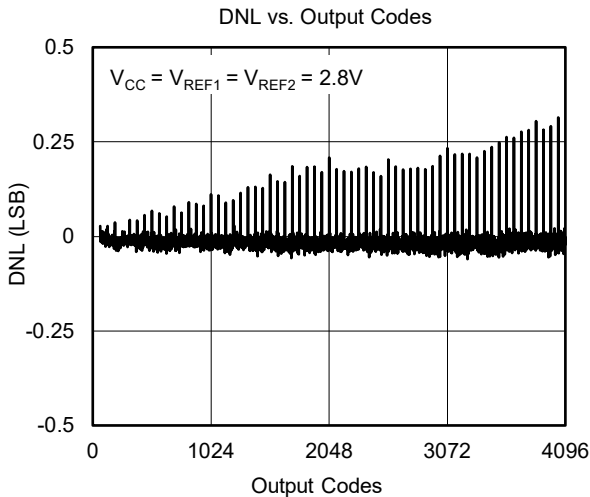

SGM5348-12 8 Channels, 12-Bit Digital-to-Analog Converter with Output Operational Amplifier

TYPICAL PERFORMANCE CHARACTERISTICS (continued)

T_A = +25°C, unless otherwise noted.

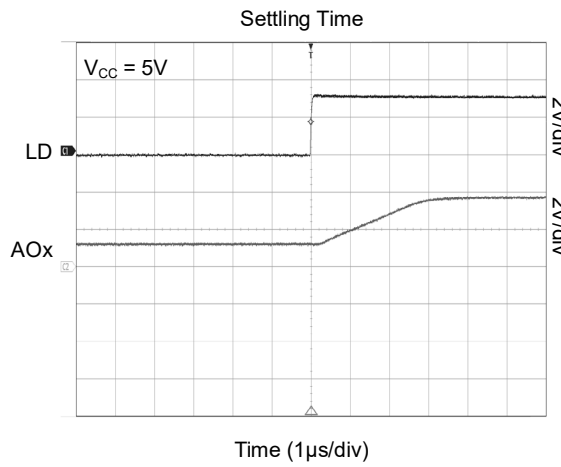
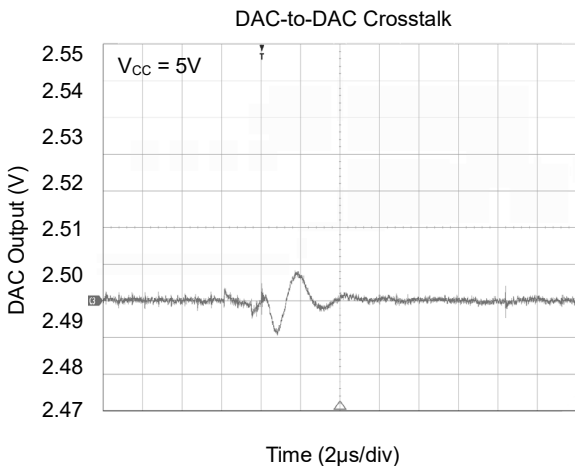
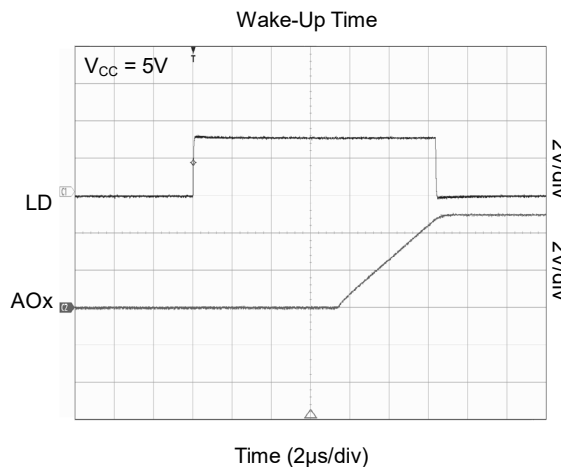
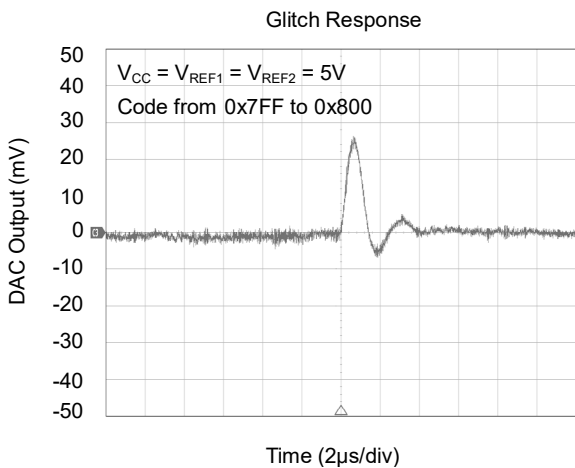
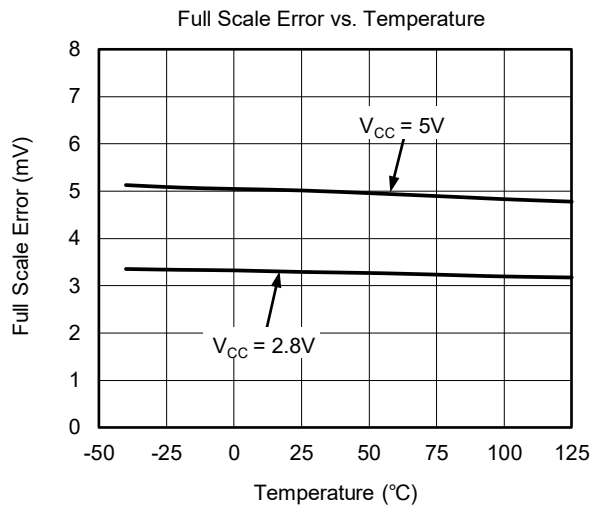
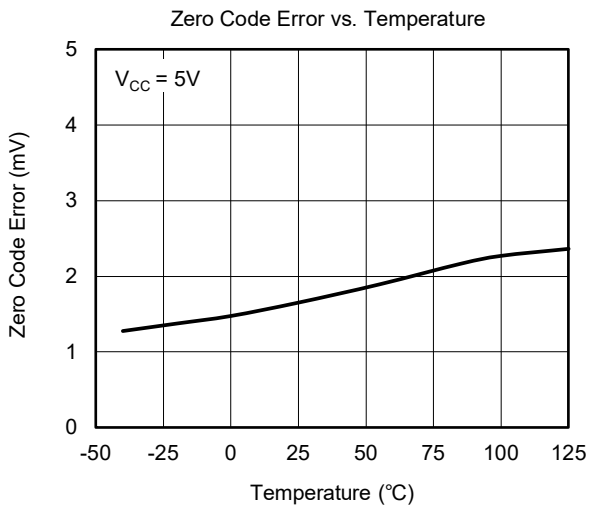

REGISTER MAPS

Shifter Register Format

The DIN is sampled by the falling edge of SCLK and shifted to a shift register. DOUT is connected to serial output of the shift register and is updated at falling edge of SCLK. The format of shifter register is shown below as an example.

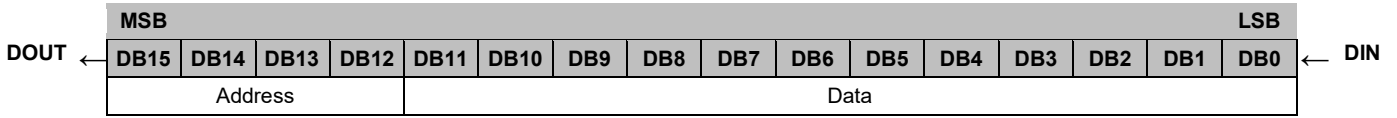

12-Bit DAC
Figure 1. Serial Data

The upper 4 bits are always for address. The lower 12 bits are for data respectively. MSB is streamed in first.

Register Address

Address				Address Selected
DB15	DB14	DB13	DB12	
0	0	0	0	Channel 1 Data Register.
0	0	0	1	Channel 2 Data Register.
0	0	1	0	Channel 3 Data Register.
0	0	1	1	Channel 4 Data Register.
0	1	0	0	Channel 5 Data Register.
0	1	0	1	Channel 6 Data Register.
0	1	1	0	Channel 7 Data Register.
0	1	1	1	Channel 8 Data Register.
1	0	0	0	Write Register Mode (WRM).
1	0	0	1	Write Through Mode (WTM).
1	0	1	0	Update Select or LDO Select.
1	0	1	1	CH1 Write Mode.
1	1	0	0	Broadcast Mode.
1	1	0	1	Hi-Z Outputs.
1	1	1	0	100kΩ Outputs.
1	1	1	1	2.5kΩ Outputs.

8 Channels, 12-Bit Digital-to-Analog Converter with Output Operational Amplifier

SGM5348-12

REGISTER MAPS (continued)

DAC Input Data Update Mechanism

The SGM5348-12 has two modes: Write Register Mode (WRM) and Write Through Mode (WTM). The detailed summaries see Table 1 and Table 2.

Table 1. WRM and WTM Details

DB[15:12]	DB[11:0]												Description	
1000	0	0	0	0	0	0	0	0	0	0	0	0	0	Write Register Mode. The DAC outputs don't change.
1001	0	0	0	0	0	0	0	0	0	0	0	0	0	Write Through Mode. DAC output will be changed.

Table 2. Commands Impacted by WRM and WTM

DB[15]	DB[14:12]	DB[11:0]												Description
0	000	D11	D10	D9	D8	D7	D6	D5	D4	D3	D2	D1	D0	In WRM: DB[11:0] written to CH1's data register only. In WTM: CH1's output is updated by data in DB[11:0].
0	001	D11	D10	D9	D8	D7	D6	D5	D4	D3	D2	D1	D0	In WRM: DB[11:0] written to CH2's data register only. In WTM: CH2's output is updated by data in DB[11:0].
0	010	D11	D10	D9	D8	D7	D6	D5	D4	D3	D2	D1	D0	In WRM: DB[11:0] written to CH3's data register only. In WTM: CH3's output is updated by data in DB[11:0].
0	011	D11	D10	D9	D8	D7	D6	D5	D4	D3	D2	D1	D0	In WRM: DB[11:0] written to CH4's data register only. In WTM: CH4's output is updated by data in DB[11:0].
0	100	D11	D10	D9	D8	D7	D6	D5	D4	D3	D2	D1	D0	In WRM: DB[11:0] written to CH5's data register only. In WTM: CH5's output is updated by data in DB[11:0].
0	101	D11	D10	D9	D8	D7	D6	D5	D4	D3	D2	D1	D0	In WRM: DB[11:0] written to CH6's data register only. In WTM: CH6's output is updated by data in DB[11:0].
0	110	D11	D10	D9	D8	D7	D6	D5	D4	D3	D2	D1	D0	In WRM: DB[11:0] written to CH7's data register only. In WTM: CH7's output is updated by data in DB[11:0].
0	111	D11	D10	D9	D8	D7	D6	D5	D4	D3	D2	D1	D0	In WRM: DB[11:0] written to CH8's data register only. In WTM: CH8's output is updated by data in DB[11:0].

A special summary of the commands is shown in Table 3.

Table 3. Special Command Operations

DB[15:12]	DB[11:0]												Description
1010	LDO1	LDO0	X	X	CH8	CH7	CH6	CH5	CH4	CH3	CH2	CH1	Update Select and LDO Select
1011	D11	D10	D9	D8	D7	D6	D5	D4	D3	D2	D1	D0	CH1 Write Mode
1100	D11	D10	D9	D8	D7	D6	D5	D4	D3	D2	D1	D0	Broadcast Mode

Power-Down Modes

Table 4. Power-Down Modes

DB[15:12]	DB[11:8]	DB7	DB6	DB5	DB4	DB3	DB2	DB1	DB0	Output Impedance
1101	XXXX	CH8	CH7	CH6	CH5	CH4	CH3	CH2	CH1	Hi-Z Outputs
1110	XXXX	CH8	CH7	CH6	CH5	CH4	CH3	CH2	CH1	100kΩ Outputs
1111	XXXX	CH8	CH7	CH6	CH5	CH4	CH3	CH2	CH1	2.5kΩ Outputs

REVISION HISTORY

NOTE: Page numbers for previous revisions may differ from page numbers in the current version.

Changes from Original (DECEMBER 2019) to REV.A	Page
Changed from product preview to production data	All

PACKAGE OUTLINE DIMENSIONS

TSSOP-16

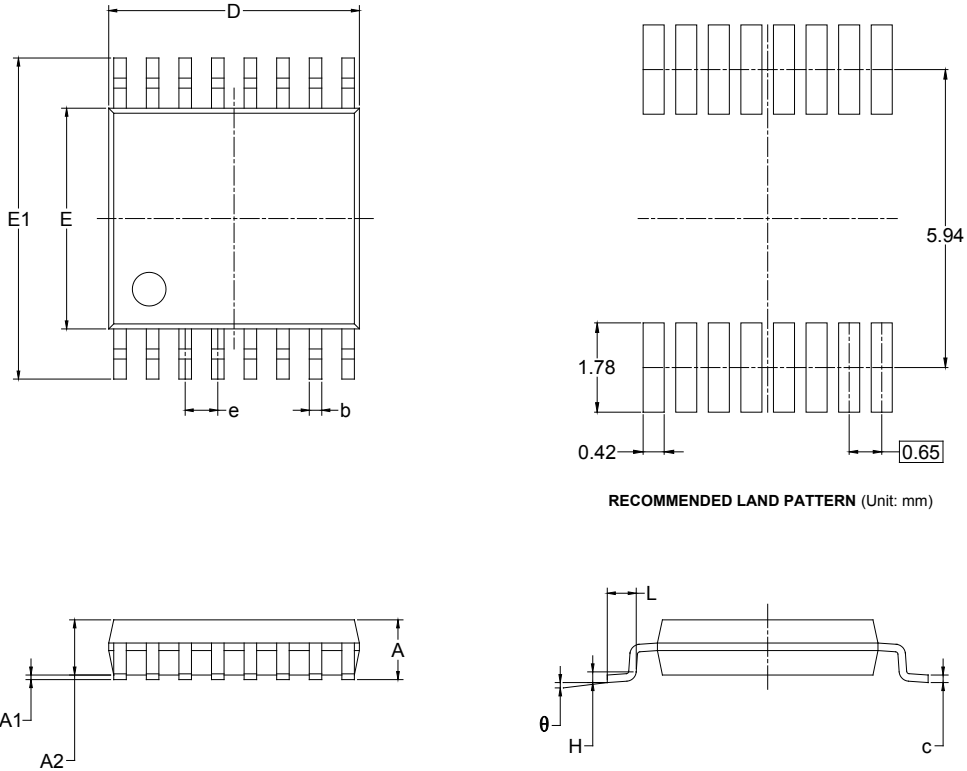

Symbol	Dimensions In Millimeters		Dimensions In Inches	
	MIN	MAX	MIN	MAX
A		1.200		0.047
A1	0.050	0.150	0.002	0.006
A2	0.800	1.050	0.031	0.041
b	0.190	0.300	0.007	0.012
c	0.090	0.200	0.004	0.008
D	4.860	5.100	0.191	0.201
E	4.300	4.500	0.169	0.177
E1	6.200	6.600	0.244	0.260
e	0.650 BSC		0.026 BSC	
L	0.500	0.700	0.02	0.028
H	0.25 TYP		0.01 TYP	
θ	1°	7°	1°	7°

PACKAGE INFORMATION

PACKAGE OUTLINE DIMENSIONS

TQFN-3×3-16L

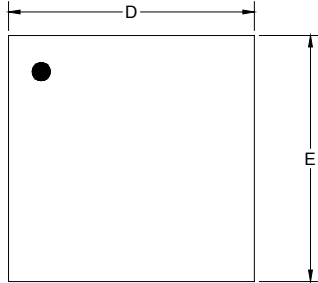

TOP VIEW

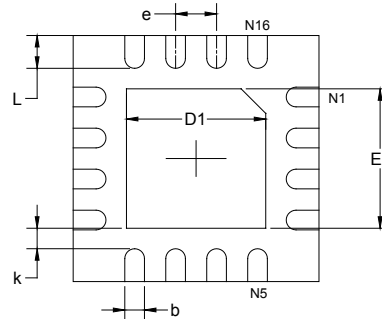

BOTTOM VIEW

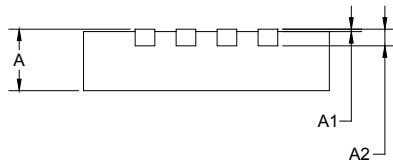

SIDE VIEW

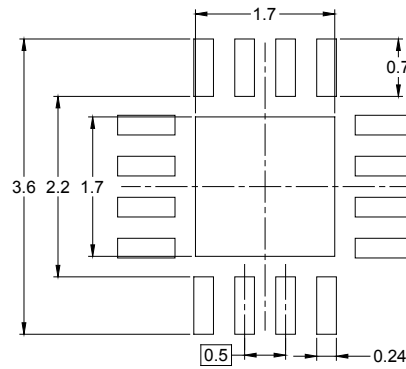

RECOMMENDED LAND PATTERN (Unit: mm)

Symbol	Dimensions In Millimeters		Dimensions In Inches	
	MIN	MAX	MIN	MAX
A	0.700	0.800	0.028	0.031
A1	0.000	0.050	0.000	0.002
A2	0.203 REF		0.008 REF	
D	2.900	3.100	0.114	0.122
D1	1.600	1.800	0.063	0.071
E	2.900	3.100	0.114	0.122
E1	1.600	1.800	0.063	0.071
k	0.200 MIN		0.008 MIN	
b	0.180	0.300	0.007	0.012
e	0.500 TYP		0.020 TYP	
L	0.300	0.500	0.012	0.020

TAPE AND REEL INFORMATION

REEL DIMENSIONS

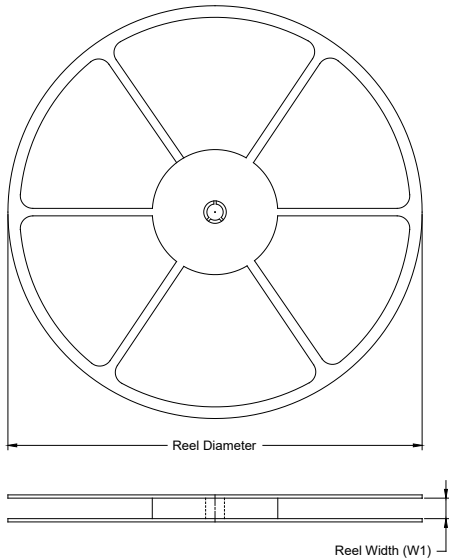

TAPE DIMENSIONS

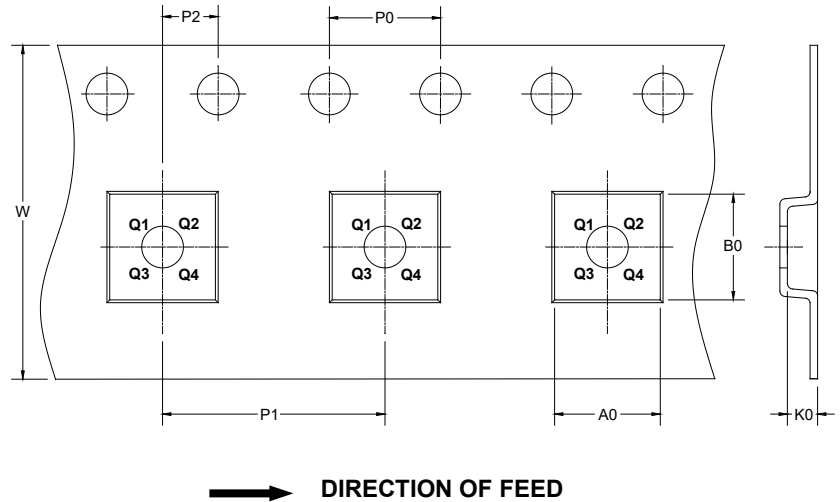

NOTE: The picture is only for reference. Please make the object as the standard.

KEY PARAMETER LIST OF TAPE AND REEL

Package Type	Reel Diameter	Reel Width W1 (mm)	A0 (mm)	B0 (mm)	K0 (mm)	P0 (mm)	P1 (mm)	P2 (mm)	W (mm)	Pin1 Quadrant
TSSOP-16	13"	12.4	6.90	5.60	1.20	4.0	8.0	2.0	12.0	Q1
TQFN-3×3-16L	13"	12.4	3.35	3.35	1.13	4.0	8.0	2.0	12.0	Q2

DD0001

PACKAGE INFORMATION

CARTON BOX DIMENSIONS



NOTE: The picture is only for reference. Please make the object as the standard.

KEY PARAMETER LIST OF CARTON BOX

Reel Type	Length (mm)	Width (mm)	Height (mm)	Pizza/Carton
13"	386	280	370	5

DD0002

单击下面可查看定价，库存，交付和生命周期等信息

[>>SGMICRO\(圣邦微电子\)](#)