

GENERAL DESCRIPTION

The SGM8922 is a dual operational amplifier designed for 5V operation. The device can operate from 3V to 5.5V single supply. It provides a wide input common mode voltage range and rail-to-rail output voltage swing.

The SGM8922 offers excellent overall performance. It features low offset, low noise and low distortion. Meanwhile, low impedance load can be used due to the characteristics of high output drive capability. The device works well in low voltage or battery-powered audio systems requiring high quality.

The SGM8922 is available in Green SOIC-8, MSOP-8 and TSSOP-8 packages and ESD (HBM) reaches 8kV. It is specified over the extended -40°C to +125°C temperature range.

APPLICATIONS

- Data Acquisition
- Process Control
- Active Filter
- Test Equipment
- Mobile Phone
- Audio Processing
- Video Processing
- Headphone Amplifier
- Portable Equipment
- Broadband Communication
- A-to-D Driver
- D-to-A Driver

FEATURES

- **Low Offset Voltage: 0.9mV (MAX, SGM8922A)**
- **Low Input Voltage Noise: 6nV/ $\sqrt{\text{Hz}}$**
- **Low Distortion**
- **High Output Voltage Swing: 4.73V (with 100mA Output Current)**
- **Low Output Voltage Swing: 0.24V (with 100mA Output Current)**
- **Gain-Bandwidth Product: 12.7MHz**
- **Slew Rate: 6.8V/ μs**
- **Rail-to-Rail Output**
- **Supply Voltage Range: 3V to 5.5V**
- **Low Supply Current: 3mA/Amplifier (TYP)**
- **-40°C to +125°C Operating Temperature Range**
- **Available in Green SOIC-8, MSOP-8 and TSSOP-8 Packages**

PIN CONFIGURATIONS

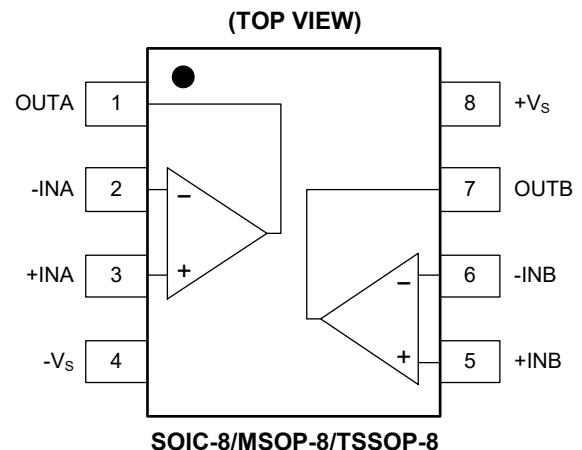

PACKAGE/ORDERING INFORMATION

MODEL	PACKAGE DESCRIPTION	SPECIFIED TEMPERATURE RANGE	ORDERING NUMBER	PACKAGE MARKING	PACKING OPTION
SGM8922	MSOP-8	-40°C to +85°C	SGM8922YMS8/TR	SGM8922 YMS8 XXXXX	Tape and Reel, 3000
	SOIC-8	-40°C to +85°C	SGM8922YS8/TR	SGM8922YS8 XXXXX	Tape and Reel, 2500
	TSSOP-8	-40°C to +85°C	SGM8922YTS8/TR	SGM8922 YTS8 XXXXX	Tape and Reel, 4000
	SOIC-8	-40°C to +125°C	SGM8922XS8/TR	SGM8922XS8 XXXXX	Tape and Reel, 2500
SGM8922A	MSOP-8	-40°C to +85°C	SGM8922AYMS8/TR	SGM8922 YMS8 XXXXX	Tape and Reel, 3000
	SOIC-8	-40°C to +85°C	SGM8922AYS8/TR	SGM8922YS8 XXXXX	Tape and Reel, 2500
	SOIC-8	-40°C to +125°C	SGM8922AXS8/TR	SGM8922XS8 XXXXX	Tape and Reel, 2500

MARKING INFORMATION

NOTE: XXXXX = Date Code and Vendor Code.

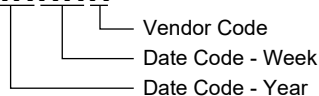
XXXXX

Green (RoHS & HSF): SG Micro Corp defines "Green" to mean Pb-Free (RoHS compatible) and free of halogen substances. If you have additional comments or questions, please contact your SGMICRO representative directly.

ABSOLUTE MAXIMUM RATINGS

Supply Voltage, +Vs to -Vs.....	6V
Input Common Mode Voltage Range.....	-0.1V to 3.8V
Package Thermal Resistance @ T _A = +25°C	
SOIC-8, θ _{JA}	82°C/W
MSOP-8, θ _{JA}	105°C/W
TSSOP-8, θ _{JA}	108°C/W
Junction Temperature	+150°C
Storage Temperature Range.....	-65°C to +150°C
Lead Temperature (Soldering, 10s)	+260°C
ESD Susceptibility	
HBM.....	8000V
MM.....	400V

RECOMMENDED OPERATING CONDITIONS

Operating Temperature Range-40°C to +125°C

OVERSTRESS CAUTION

Stresses beyond those listed in Absolute Maximum Ratings may cause permanent damage to the device. Exposure to absolute maximum rating conditions for extended periods

may affect reliability. Functional operation of the device at any conditions beyond those indicated in the Recommended Operating Conditions section is not implied.

ESD SENSITIVITY CAUTION

This integrated circuit can be damaged if ESD protections are not considered carefully. SGMICRO recommends that all integrated circuits be handled with appropriate precautions. Failure to observe proper handling and installation procedures can cause damage. ESD damage can range from subtle performance degradation to complete device failure. Precision integrated circuits may be more susceptible to damage because even small parametric changes could cause the device not to meet the published specifications.

DISCLAIMER

SG Micro Corp reserves the right to make any change in circuit design, or specifications without prior notice.

ELECTRICAL CHARACTERISTICS

(At $T_A = +25^\circ\text{C}$, $V_S = 5\text{V}$, $R_L = 600\Omega$ connected to $V_S/2$, unless otherwise noted.)

PARAMETER	CONDITIONS	SGM8922						
		TYP	MIN/MAX OVER TEMPERATURE				UNITS	MIN /MAX
		+25°C	+25°C	-40°C to +85°C	-40°C to +125°C			
Dynamic Performance								
Gain-Bandwidth Product (GBP)	$R_L = 600\Omega$	12.7					MHz	TYP
Slew Rate	$2V_{PP}$ step, $A_V = 1$	6.8					$\text{V}/\mu\text{s}$	TYP
Crosstalk	$f = 1\text{kHz}$	-120					dB	TYP
Noise/Distortion Performance								
Total Harmonic Distortion + Noise (THD+N)	$V_{OUT} = 2V_{PP}$, $f = 1\text{kHz}$, $A_V = 1$, $R_L = 600\Omega$	0.003					%	TYP
Input Voltage Noise Density (e_n)	$f = 1\text{kHz}$	6					$\text{nV}/\sqrt{\text{Hz}}$	TYP
Phase Margin	$R_L = 600\Omega$, $C_L = 100\text{pF}$	45					degree	TYP
DC Performance								
Input Offset Voltage (V_{OS})	SGM8922		3	4.2	5		mV	MAX
	SGM8922A		0.9	1.8	2.6		mV	MAX
Input Offset Voltage Drift		1.6					$\mu\text{V}/^\circ\text{C}$	TYP
Open-Loop Gain (A_{OL})	$R_L = 600\Omega$, $V_{OUT} = 0.15\text{V}$ to 4.85V	109	86	80	75		dB	MIN
	$R_L = 10\text{k}\Omega$, $V_{OUT} = 0.05\text{V}$ to 4.95V	104	84	75	70		dB	MIN
Input Characteristics								
Input Common Mode Voltage Range (V_{CM})	$V_S = 5\text{V}$	-0.1 to 3.8					V	TYP
Common Mode Rejection Ratio (CMRR)	$V_S = 5.5\text{V}$, $V_{CM} = -0.1\text{V}$ to 3.8V	108	60	56	51		dB	MIN
Output Characteristics								
Output Voltage Swing from Rails	V_{OH}	$I_{OUT} = 100\text{mA}$	4.73	4.20	4.10	4	V	MIN
	V_{OL}	$I_{OUT} = -100\text{mA}$	0.24	0.45	0.56	0.68	V	MAX
Output Short-Circuit Current			300				mA	MAX
Power Supply								
Operating Voltage Range			3	3	3		V	MIN
			5.5	5.5	5.5		V	MAX
Quiescent Current (per Amplifier)	$I_{OUT} = 0\text{mA}$	3	3.9				mA	MAX
Power Supply Rejection Ratio (PSRR)	$V_S = 2.5\text{V}$ to 5.5V ,							
	$V_{CM} = (-V_S) + 0.5\text{V}$	80	60	56	51		dB	MIN

TYPICAL PERFORMANCE CHARACTERISTICS

At $T_A = +25^\circ\text{C}$, $A_V = +1$, $C_L = 100\text{pF}$ and $R_L = 600\Omega$, unless otherwise noted.

Small Signal Step Response

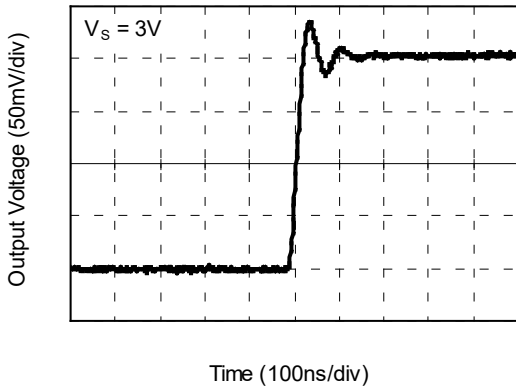

Small Signal Step Response

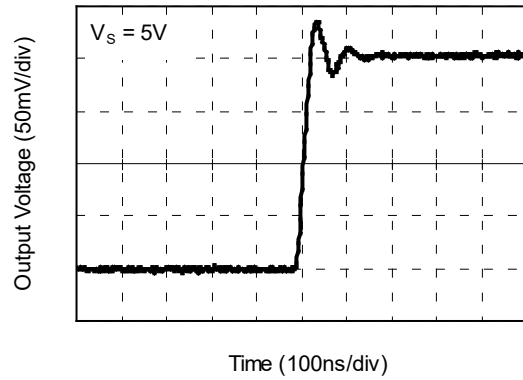

Large Signal Step Response

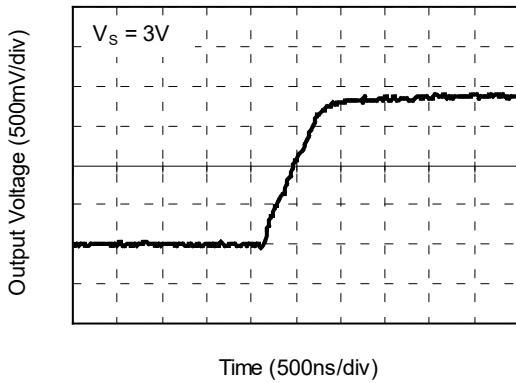

Large Signal Step Response

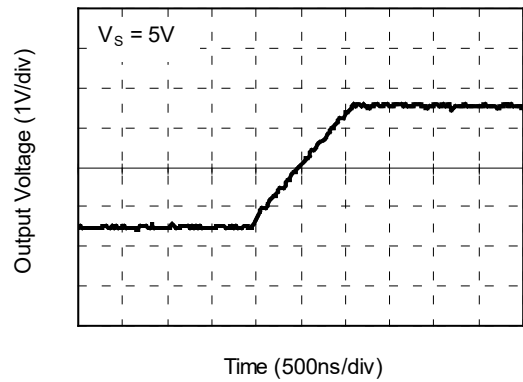

THD+N vs. Frequency

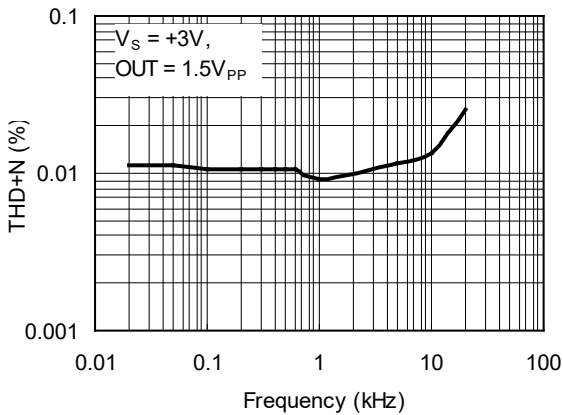

THD+N vs. Frequency

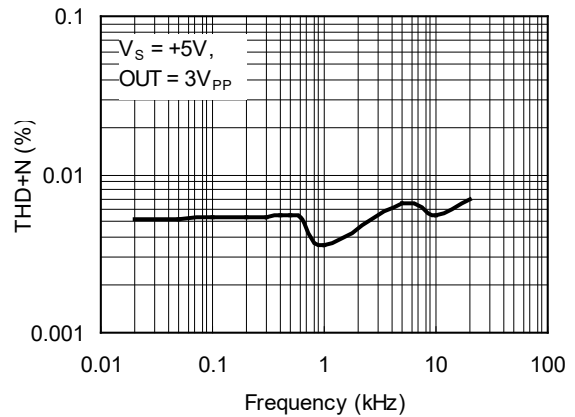

TYPICAL PERFORMANCE CHARACTERISTICS (continued)

At $T_A = +25^\circ\text{C}$, $A_v = +1$, $C_L = 100\text{pF}$ and $R_L = 600\Omega$, unless otherwise noted.

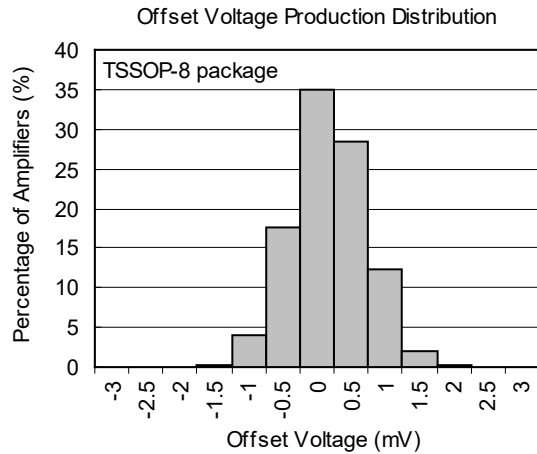
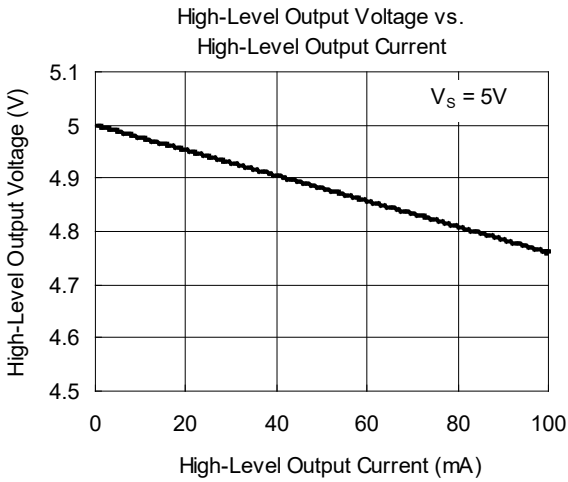
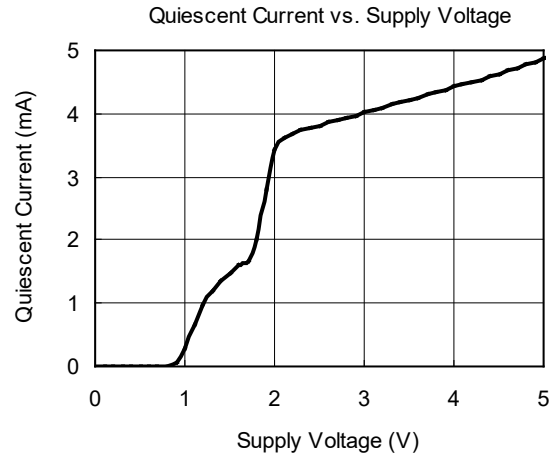
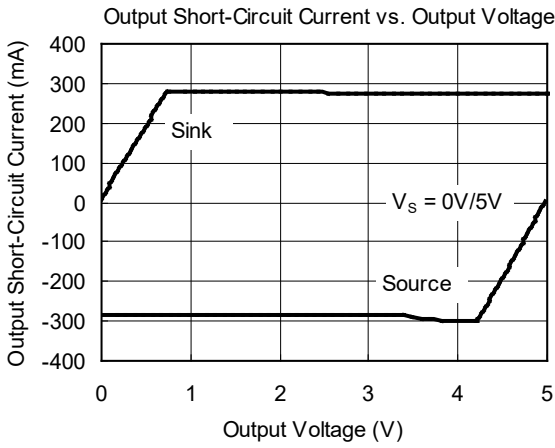

REVISION HISTORY

NOTE: Page numbers for previous revisions may differ from page numbers in the current version.

OCTOBER 2014 – REV.B.4 to REV.C	Page
Changed Package/Ordering Information section.....	2
<hr/>	
APRIL 2013 – REV.B.3 to REV.B.4	Page
Changed Electrical Characteristics section	3
<hr/>	
JANUARY 2013 – REV.B.2 to REV.B.3	Page
Added Tape and Reel Information section	9, 10
<hr/>	
Changes from Original (APRIL 2018) to REV.A	Page
Changed from product preview to production data.....	All

PACKAGE OUTLINE DIMENSIONS

SOIC-8

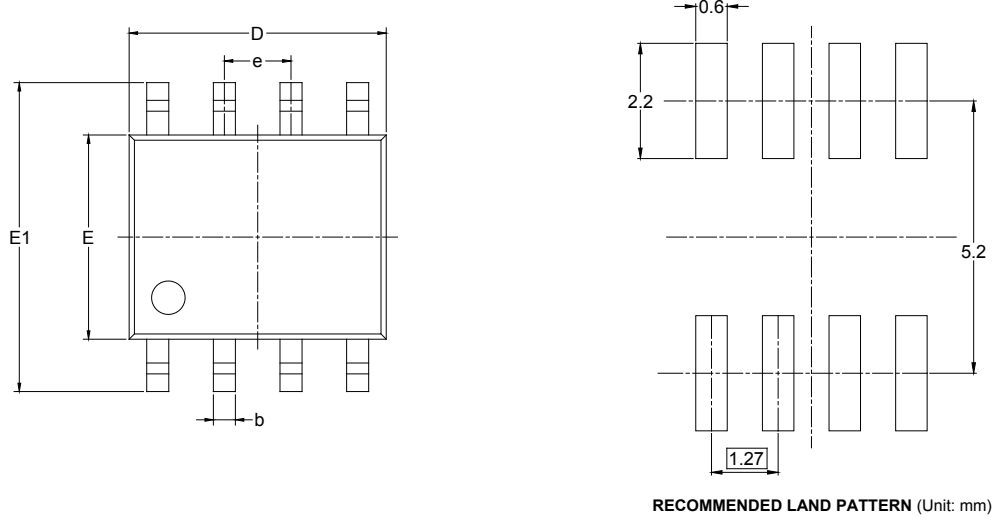

Symbol	Dimensions In Millimeters		Dimensions In Inches	
	MIN	MAX	MIN	MAX
A	1.350	1.750	0.053	0.069
A1	0.100	0.250	0.004	0.010
A2	1.350	1.550	0.053	0.061
b	0.330	0.510	0.013	0.020
c	0.170	0.250	0.006	0.010
D	4.700	5.100	0.185	0.200
E	3.800	4.000	0.150	0.157
E1	5.800	6.200	0.228	0.244
e	1.27 BSC		0.050 BSC	
L	0.400	1.270	0.016	0.050
θ	0°	8°	0°	8°

PACKAGE OUTLINE DIMENSIONS

MSOP-8

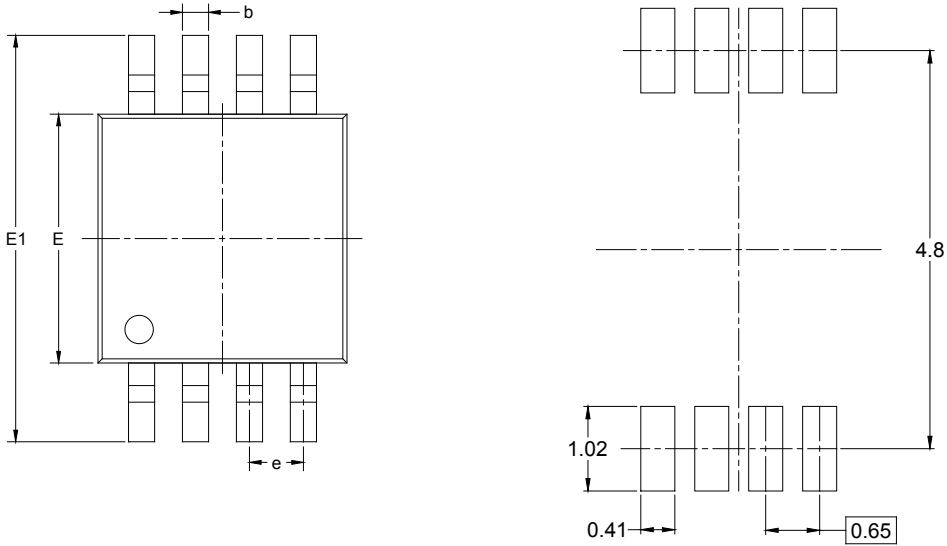

RECOMMENDED LAND PATTERN (Unit: mm)

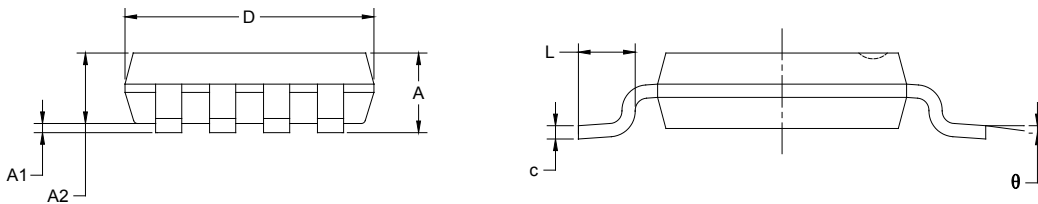

Symbol	Dimensions In Millimeters		Dimensions In Inches	
	MIN	MAX	MIN	MAX
A	0.820	1.100	0.032	0.043
A1	0.020	0.150	0.001	0.006
A2	0.750	0.950	0.030	0.037
b	0.250	0.380	0.010	0.015
c	0.090	0.230	0.004	0.009
D	2.900	3.100	0.114	0.122
E	2.900	3.100	0.114	0.122
E1	4.750	5.050	0.187	0.199
e	0.650 BSC		0.026 BSC	
L	0.400	0.800	0.016	0.031
θ	0°	6°	0°	6°

PACKAGE OUTLINE DIMENSIONS

TSSOP-8

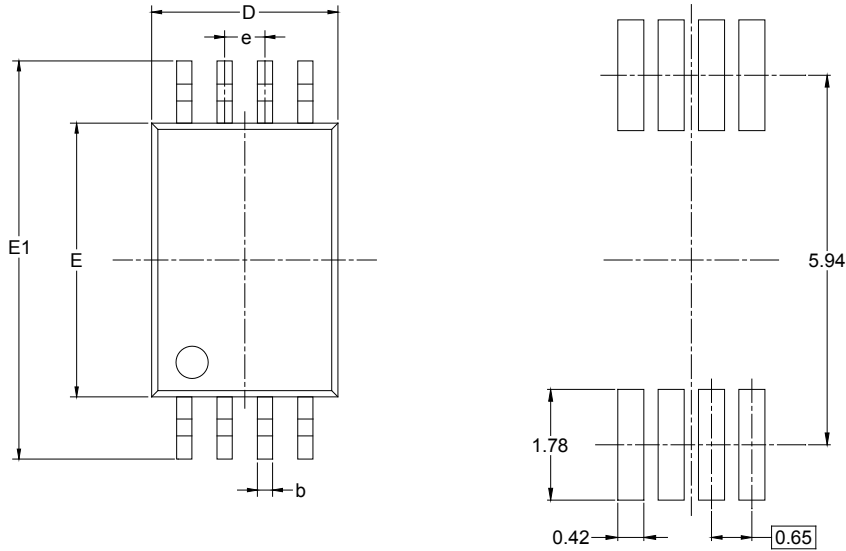

RECOMMENDED LAND PATTERN (Unit: mm)

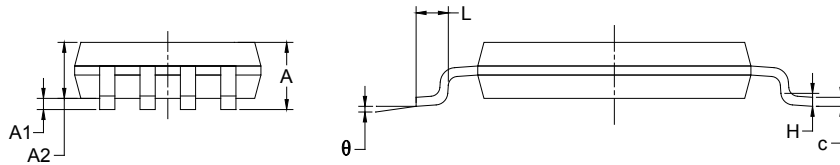

Symbol	Dimensions In Millimeters		Dimensions In Inches	
	MIN	MAX	MIN	MAX
A		1.100		0.043
A1	0.050	0.150	0.002	0.006
A2	0.800	1.000	0.031	0.039
b	0.190	0.300	0.007	0.012
c	0.090	0.200	0.004	0.008
D	2.900	3.100	0.114	0.122
E	4.300	4.500	0.169	0.177
E1	6.250	6.550	0.246	0.258
e	0.650 BSC		0.026 BSC	
L	0.500	0.700	0.02	0.028
H	0.25 TYP		0.01 TYP	
θ	1°	7°	1°	7°

PACKAGE INFORMATION

TAPE AND REEL INFORMATION

REEL DIMENSIONS



TAPE DIMENSIONS



NOTE: The picture is only for reference. Please make the object as the standard.

KEY PARAMETER LIST OF TAPE AND REEL

Package Type	Reel Diameter	Reel Width W1 (mm)	A0 (mm)	B0 (mm)	K0 (mm)	P0 (mm)	P1 (mm)	P2 (mm)	W (mm)	Pin1 Quadrant
SOIC-8	13"	12.4	6.40	5.40	2.10	4.0	8.0	2.0	12.0	Q1
MSOP-8	13"	12.4	5.20	3.30	1.50	4.0	8.0	2.0	12.0	Q1
TSSOP-8	13"	12.4	6.76	3.30	1.80	4.0	8.0	2.0	12.0	Q1

DD0001

PACKAGE INFORMATION

CARTON BOX DIMENSIONS



NOTE: The picture is only for reference. Please make the object as the standard.

KEY PARAMETER LIST OF CARTON BOX

Reel Type	Length (mm)	Width (mm)	Height (mm)	Pizza/Carton
13"	386	280	370	5

DD0002

单击下面可查看定价，库存，交付和生命周期等信息

[>>SGMICRO\(圣邦微电子\)](#)