



SGM4996

1.3W Fully Differential Audio Power Amplifier with Selectable Shutdown

GENERAL DESCRIPTION

The SGM4996 is a fully differential audio power amplifier which operates from 2.5V to 5.5V power supply. It can deliver 1.3W into a 8Ω load from 5V supply at THD+N = 1%. It is designed for portable applications.

The SGM4996 has pop/click suppression circuitry, low power consumption shutdown mode and thermal shutdown protection. The shutdown function may be realized by either a logic high or low, which is up to the voltage acted on the SD MODE pin.

Bootstrap capacitors or output coupling capacitors are not needed.

The SGM4996 is available in Green MSOP-10, TDFN-3×3-10L and MSOP-8 packages. It operates over an ambient temperature range of -40°C to +85°C.

FEATURES

- **Supply Voltage Range: 2.5V to 5.5V**
- **1.3W into 8Ω Load from 5V Supply at THD+N = 1% (TYP)**
- **High PSRR**
- **Low Shutdown Current**
- **Pop/Click Suppression Circuitry**
- **Support Single-Ended or Differential Input**
- **Thermal Overload Protection Circuitry**
- **External Gain Configuration Capability**
- **-40°C to +85°C Operating Temperature Range**
- **Available in Green MSOP-10, TDFN-3×3-10L and MSOP-8 Packages**

APPLICATIONS

PDAs
GPS
Mobile Phones
Wireless Handsets
Handheld Computers
Portable Systems

PACKAGE/ORDERING INFORMATION

MODEL	PACKAGE DESCRIPTION	SPECIFIED TEMPERATURE RANGE	ORDERING NUMBER	PACKAGE MARKING	PACKING OPTION
SGM4996	MSOP-10	-40°C to +85°C	SGM4996YMS10G/TR	SGM4996 YMS10 XXXXX	Tape and Reel, 4000
	TDFN-3x3-10L	-40°C to +85°C	SGM4996YD10G/TR	SGM 4996D XXXXX	Tape and Reel, 3000
	MSOP-8	-40°C to +85°C	SGM4996YMS8G/TR	SGM4996 YMS8 XXXXX	Tape and Reel, 4000

MARKING INFORMATION

NOTE: XXXXX = Date Code and Vendor Code.

XXXXX

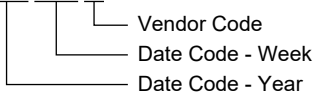

Green (RoHS & HSF): SG Micro Corp defines "Green" to mean Pb-Free (RoHS compatible) and free of halogen substances. If you have additional comments or questions, please contact your SGMICRO representative directly.

ABSOLUTE MAXIMUM RATINGS

- Supply Voltage.....6V
- Input Voltage..... -0.3V to (V_{CC}) + 0.3V
- Storage Temperature Range-65°C to +150°C
- Junction Temperature.....150°C
- Lead Temperature (Soldering, 10s)+260°C
- ESD Susceptibility
- HBM.....4000V
- MM.....400V

RECOMMENDED OPERATING CONDITIONS

- Supply Voltage Range2.5V to 5.5V
- Operating Temperature Range-40°C to +85°C

OVERSTRESS CAUTION

Stresses beyond those listed may cause permanent damage to the device. Functional operation of the device at these or any other conditions beyond those indicated in the operational section of the specification is not implied. Exposure to absolute maximum rating conditions for extended periods may affect reliability.

ESD SENSITIVITY CAUTION

This integrated circuit can be damaged by ESD if you don't pay attention to ESD protection. SGMICRO recommends that all integrated circuits be handled with appropriate precautions. Failure to observe proper handling and installation procedures can cause damage. ESD damage can range from subtle performance degradation to complete device failure. Precision integrated circuits may be more susceptible to damage because very small parametric changes could cause the device not to meet its published specifications.

DISCLAIMER

SG Micro Corp reserves the right to make any change in circuit design, specification or other related things if necessary without notice at any time.

PIN CONFIGURATIONS

(TOP VIEW)

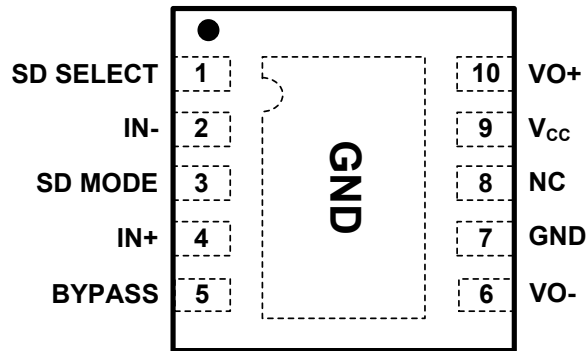

TDFN-3x3-10L

(TOP VIEW)

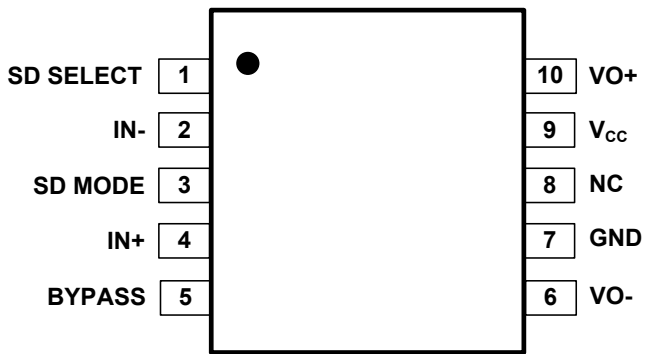

MSOP-10

(TOP VIEW)

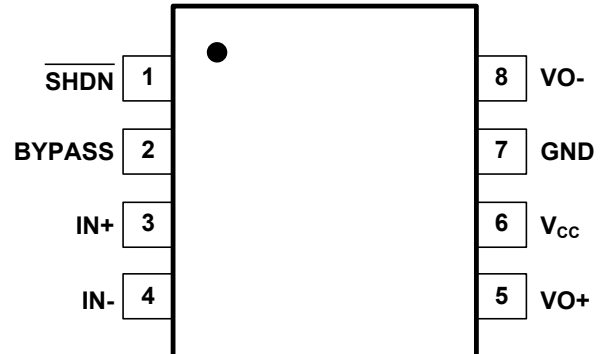

MSOP-8

ELECTRICAL CHARACTERISTICS

(The following AC specifications apply for 8Ω load, $A_V = 1V/V$, $T_A = +25^\circ\text{C}$, unless otherwise specified.)

PARAMETER	SYMBOL	CONDITIONS	MIN	TYP	MAX	UNITS
Supply Voltage	V_{CC}		2.5		5.5	V
Shutdown Current	I_{SD}	SDM = SDS = GND or SDM = SDS = V_{CC}	$V_{CC} = 5.0V$	0.01	2	μA
			$V_{CC} = 3.6V$	0.01		
			$V_{CC} = 2.6V$	0.01		
Output Offset Voltage	V_{OS}	$V_{IN} = 0V, I_O = 0A$	-10	2	10	mV
Quiescent Power Supply Current	I_Q	$V_{IN} = 0V$	$V_{CC} = 5.0V, \text{No Load}$	4.70	7.5	mA
			$V_{CC} = 5.0V, 8\Omega \text{ Load}$	4.73	8	
			$V_{CC} = 3.6V, \text{No Load}$	3.85	6	
			$V_{CC} = 3.6V, 8\Omega \text{ Load}$	3.87		
			$V_{CC} = 2.6V, \text{No Load}$	3.20		
			$V_{CC} = 2.6V, 8\Omega \text{ Load}$	3.21		
SD SELECT Threshold High	V_{SDSIH}		1.2			V
SD SELECT Threshold Low	V_{SDSIL}			0.4		
SD MODE Threshold High	V_{SDMIH}		1.2			
SD MODE Threshold Low	V_{SDMIL}			0.4		
Output Power (8Ω)	P_O	$f = 1\text{kHz},$ $\text{THD+N} = 1\%$	$V_{CC} = 5.0V$	1.30		W
			$V_{CC} = 3.6V$	0.66		
			$V_{CC} = 3.0V$	0.46		
			$V_{CC} = 2.6V$	0.33		
		$f = 1\text{kHz},$ $\text{THD+N} = 10\%$	$V_{CC} = 5.0V$	1.60		
			$V_{CC} = 3.6V$	0.82		
			$V_{CC} = 3.0V$	0.57		
			$V_{CC} = 2.6V$	0.41		
Total Harmonic Distortion + Noise	THD+N	$P_O = 0.6W_{rms}, f = 1\text{kHz}, V_{CC} = 5.0V$		0.013		%
Power Supply Rejection Ratio ⁽¹⁾⁽²⁾	PSRR	$V_{RIPPLE} = 200mV_{P-P}$ $C_B = 1\mu F, f = 217\text{Hz}$	$V_{CC} = 5.0V$	-85		dB
			$V_{CC} = 3.6V$	-81		
			$V_{CC} = 3.0V$	-64		
			$V_{CC} = 2.6V$	-54		
		$V_{RIPPLE} = 200mV_{P-P}$ $C_B = 1\mu F, f = 1\text{kHz}$	$V_{CC} = 5.0V$	-83		
			$V_{CC} = 3.6V$	-80		
			$V_{CC} = 3.0V$	-64		
			$V_{CC} = 2.6V$	-54		
Common Mode Rejection Ratio ⁽²⁾	CMRR	$f = 217\text{Hz}, V_{CM} = 200mV_{P-P}, V_{CC} = 5.0V$		-81		dB
Wake-Up Time	T_{WU}	$C_B = 1\mu F$	$V_{CC} = 5.0V$	68		ms
			$V_{CC} = 3.6V$	53		
			$V_{CC} = 3.0V$	45		
			$V_{CC} = 2.6V$	40		

NOTES:

- 10Ω terminated input.
- PSRR and CMRR are affected by the matching between gain-setting resistor ratios.

TYPICAL PERFORMANCE CHARACTERISTICS

At $T_A = +25^\circ\text{C}$, $A_V = 1$, $f = 1\text{kHz}$, $C_B = 1\mu\text{F}$, unless otherwise noted.

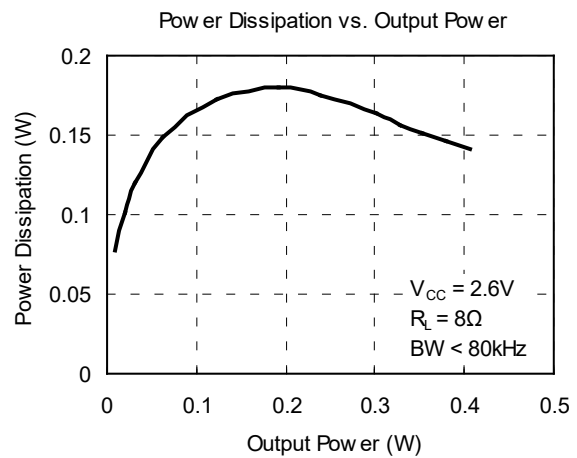
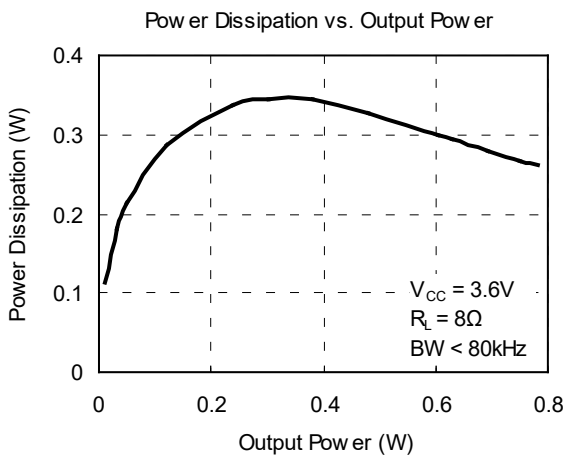
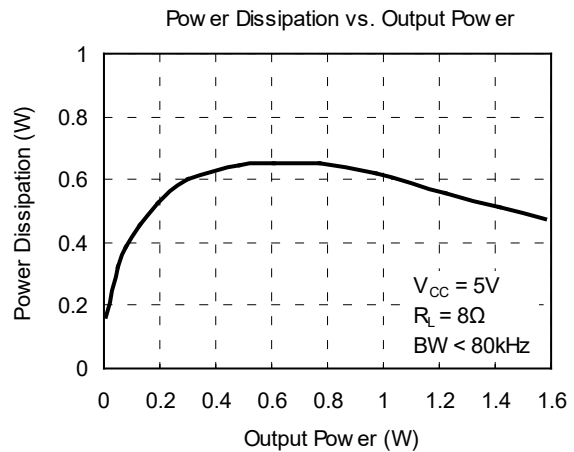
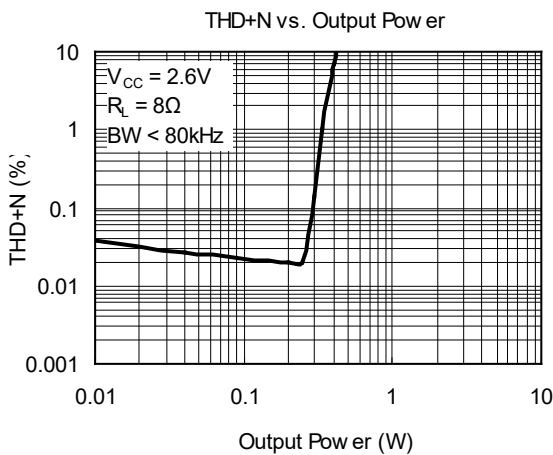
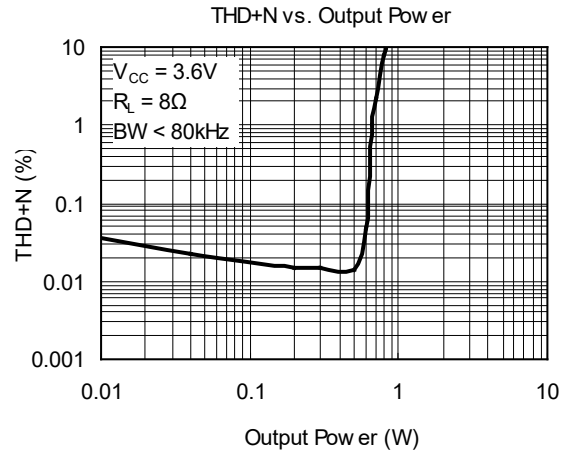
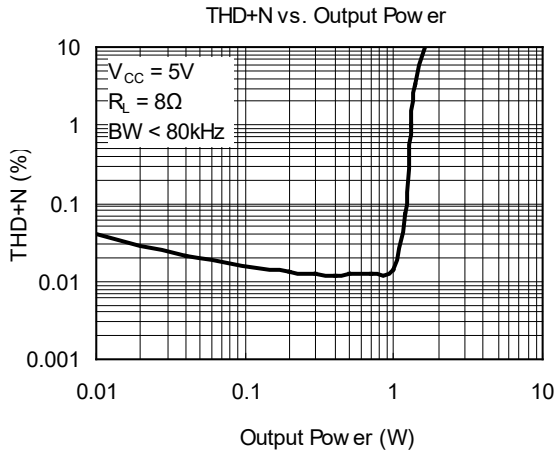

TYPICAL PERFORMANCE CHARACTERISTICS (continued)

At $T_A = +25^\circ\text{C}$, $A_V = 1$, $f = 1\text{kHz}$, $C_B = 1\mu\text{F}$, unless otherwise noted.

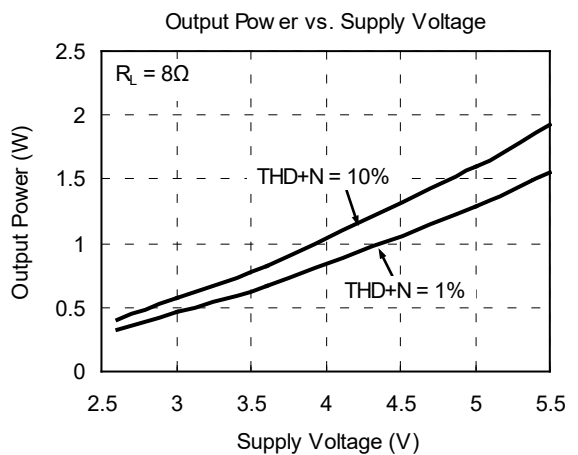
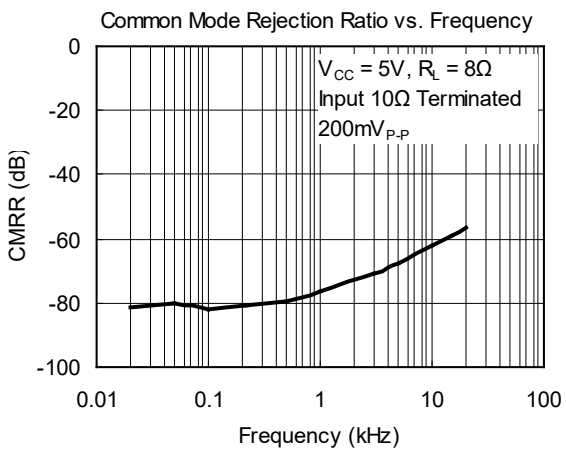
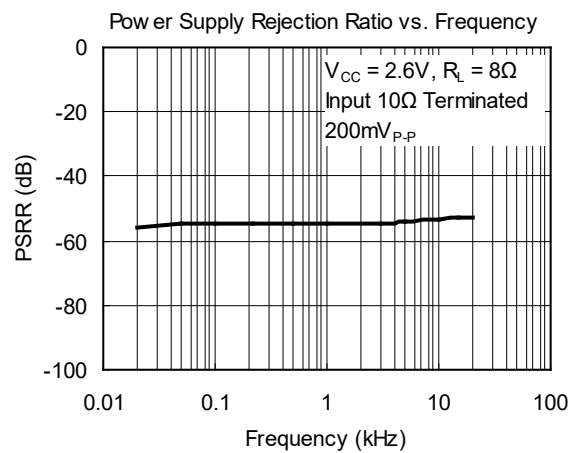
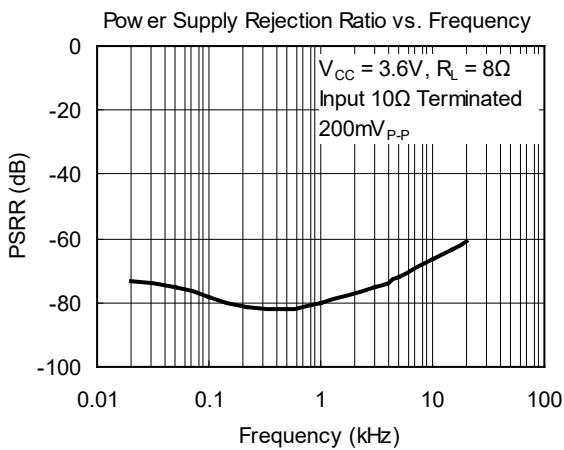
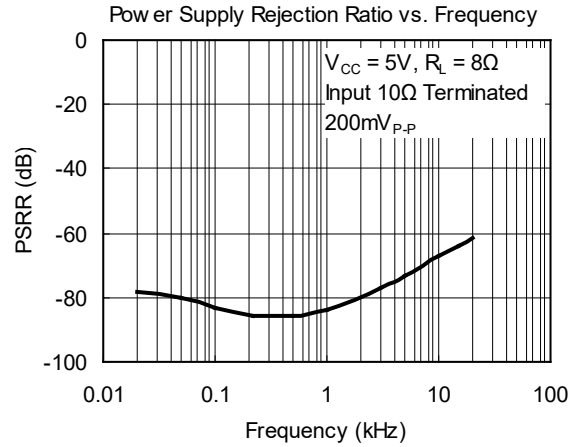
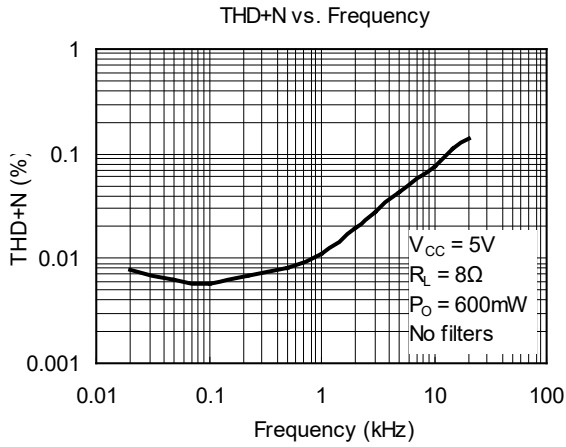

TYPICAL PERFORMANCE CHARACTERISTICS (continued)

At $T_A = +25^\circ\text{C}$, $A_V = 1$, $f = 1\text{kHz}$, $C_B = 1\mu\text{F}$, unless otherwise noted.

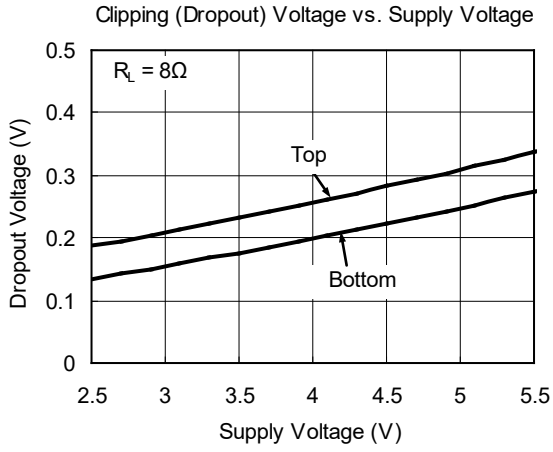

REVISION HISTORY

NOTE: Page numbers for previous revisions may differ from page numbers in the current version.

MARCH 2017 – REV.A.2 to REV.A.3

Changed Packing Option 2

NOVEMBER 2012 – REV.A.1 to REV.A.2

Added notes of Typical Application Circuits 8, 9, 10, 11

MAY 2011 – REV.A to REV.A.1

Updated Package Description All

Changes from Original (MARCH 2010) to REV.A

Changed from product preview to production data All

PACKAGE OUTLINE DIMENSIONS

MSOP-8

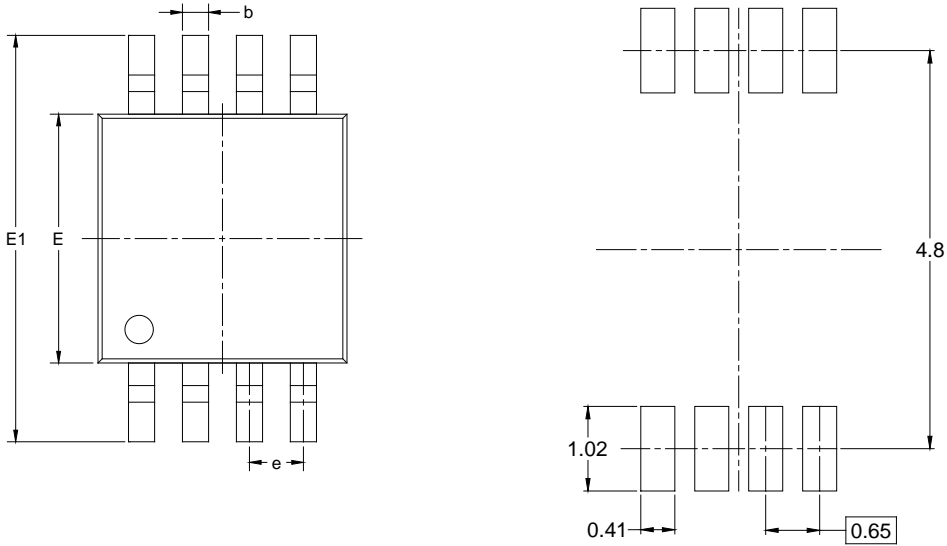

RECOMMENDED LAND PATTERN (Unit: mm)

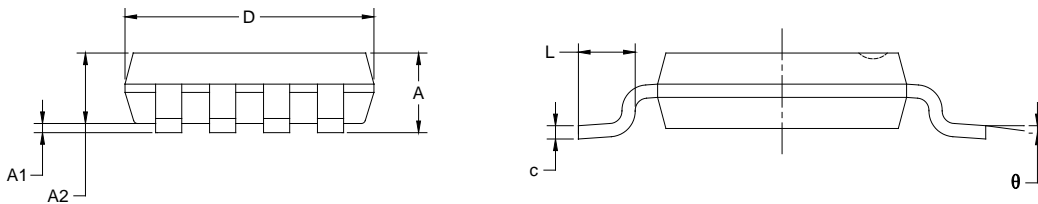

Symbol	Dimensions In Millimeters		Dimensions In Inches	
	MIN	MAX	MIN	MAX
A	0.820	1.100	0.032	0.043
A1	0.020	0.150	0.001	0.006
A2	0.750	0.950	0.030	0.037
b	0.250	0.380	0.010	0.015
c	0.090	0.230	0.004	0.009
D	2.900	3.100	0.114	0.122
E	2.900	3.100	0.114	0.122
E1	4.750	5.050	0.187	0.199
e	0.650 BSC		0.026 BSC	
L	0.400	0.800	0.016	0.031
θ	0°	6°	0°	6°

NOTES:

1. Body dimensions do not include mode flash or protrusion.
2. This drawing is subject to change without notice.

PACKAGE OUTLINE DIMENSIONS

MSOP-10

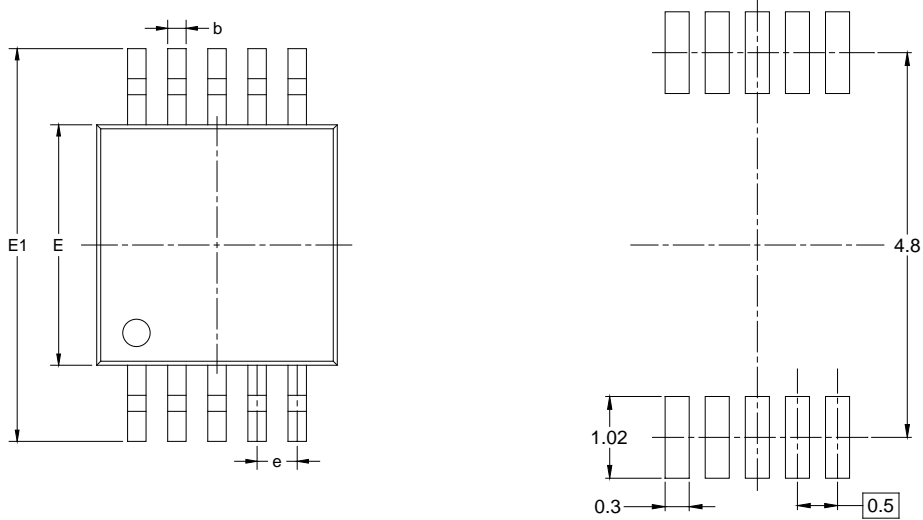

RECOMMENDED LAND PATTERN (Unit: mm)

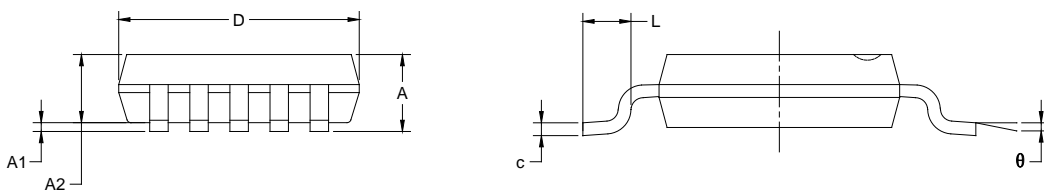

Symbol	Dimensions In Millimeters		Dimensions In Inches	
	MIN	MAX	MIN	MAX
A	0.820	1.100	0.032	0.043
A1	0.020	0.150	0.001	0.006
A2	0.750	0.950	0.030	0.037
b	0.180	0.280	0.007	0.011
c	0.090	0.230	0.004	0.009
D	2.900	3.100	0.114	0.122
E	2.900	3.100	0.114	0.122
E1	4.750	5.050	0.187	0.199
e	0.500 BSC		0.020 BSC	
L	0.400	0.800	0.016	0.031
θ	0°	6°	0°	6°

NOTES:

1. Body dimensions do not include mode flash or protrusion.
2. This drawing is subject to change without notice.

PACKAGE OUTLINE DIMENSIONS

TDFN-3x3-10L

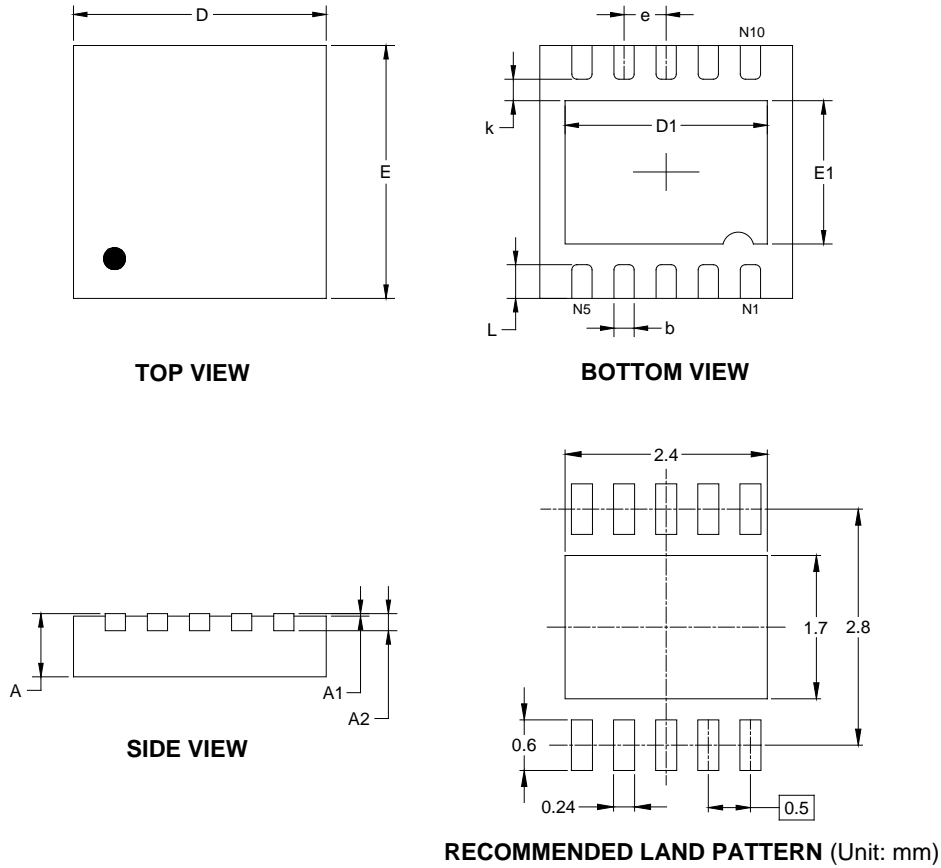

RECOMMENDED LAND PATTERN (Unit: mm)

Symbol	Dimensions In Millimeters		Dimensions In Inches	
	MIN	MAX	MIN	MAX
A	0.700	0.800	0.028	0.031
A1	0.000	0.050	0.000	0.002
A2	0.203 REF		0.008 REF	
D	2.900	3.100	0.114	0.122
D1	2.300	2.600	0.091	0.103
E	2.900	3.100	0.114	0.122
E1	1.500	1.800	0.059	0.071
k	0.200 MIN		0.008 MIN	
b	0.180	0.300	0.007	0.012
e	0.500 TYP		0.020 TYP	
L	0.300	0.500	0.012	0.020

NOTE: This drawing is subject to change without notice.

PACKAGE INFORMATION

TAPE AND REEL INFORMATION

REEL DIMENSIONS



TAPE DIMENSIONS



NOTE: The picture is only for reference. Please make the object as the standard.

KEY PARAMETER LIST OF TAPE AND REEL

Package Type	Reel Diameter	Reel Width W1 (mm)	A0 (mm)	B0 (mm)	K0 (mm)	P0 (mm)	P1 (mm)	P2 (mm)	W (mm)	Pin1 Quadrant
MSOP-8	13"	12.4	5.20	3.30	1.50	4.0	8.0	2.0	12.0	Q1
MSOP-10	13"	12.4	5.20	3.30	1.20	4.0	8.0	2.0	12.0	Q1
TDFN-3×3-10L	13"	12.4	3.35	3.35	1.13	4.0	8.0	2.0	12.0	Q1

DD0001

PACKAGE INFORMATION

CARTON BOX DIMENSIONS



NOTE: The picture is only for reference. Please make the object as the standard.

KEY PARAMETER LIST OF CARTON BOX

Reel Type	Length (mm)	Width (mm)	Height (mm)	Pizza/Carton
13"	386	280	370	5

DD0002

单击下面可查看定价，库存，交付和生命周期等信息

[>>SGMICRO\(圣邦微电子\)](#)