



# SGM8965-1/SGM8965-2 50MHz, Low Distortion, Rail-to-Rail I/O, Single-Supply Operational Amplifiers

## GENERAL DESCRIPTION

The single SGM8965-1 and dual SGM8965-2 are high speed CMOS operational amplifiers with high input impedance, zero-crossover and low distortion. These devices can operate from 2.2V to 5.5V single supply.

The SGM8965-1/2 feature high speed and low noise. These devices support rail-to-rail input and output operation. They have a wide input common mode voltage range and output swing within 8mV. Furthermore, the SGM8965-1/2 provide high CMRR with zero-crossover and low distortion, which are designed to drive ADCs with high linearity. They can be used in a variety of applications.

The SGM8965-1 is available in Green SOT-23-5 and SOIC-8 packages. The SGM8965-2 is available in Green SOIC-8 and MSOP-8 packages. They are specified over the extended -40 °C to +125 °C temperature range.

## FEATURES

- **Gain-Bandwidth Product: 50MHz**
- **Slew Rate: 30V/μs**
- **Stable When Gain ≥ 4**
- **High CMRR: 100dB (TYP)**
- **Excellent THD+N: 0.00015%**
- **Low Offset Voltage: 250μV (MAX)**
- **Low Bias Current: 0.5pA (TYP)**
- **Low Input Voltage Noise: 4.5nV/√Hz at 100kHz**
- **Rail-to-Rail Input and Output**
- **Supply Voltage Range: 2.2V to 5.5V**
- **-40°C to +125°C Operating Temperature Range**
- **Small Packaging:**
  - **SGM8965-1 Available in Green SOT-23-5 and SOIC-8 Packages**
  - **SGM8965-2 Available in Green SOIC-8 and MSOP-8 Packages**

## APPLICATIONS

Audio  
Active Filter  
Signal Conditioning  
Sensor Amplification  
Data Acquisition  
Process Control  
Test Equipment  
Wideband Amplifier

**PACKAGE/ORDERING INFORMATION**

MODEL	PACKAGE DESCRIPTION	SPECIFIED TEMPERATURE RANGE	ORDERING NUMBER	PACKAGE MARKING	PACKING OPTION
SGM8965-1	SOT-23-5	-40°C to +125°C	SGM8965-1XN5G/TR	SZ9XX	Tape and Reel, 3000
	SOIC-8	-40°C to +125°C	SGM8965-1XS8G/TR	SGM 89651XS8 XXXXX	Tape and Reel, 2500
SGM8965-2	SOIC-8	-40°C to +125°C	SGM8965-2XS8G/TR	SGM 89652XS8 XXXXX	Tape and Reel, 2500
	MSOP-8	-40°C to +125°C	SGM8965-2XMS8G/TR	SGM89652 XMS8 XXXXX	Tape and Reel, 4000

**MARKING INFORMATION**

NOTE: XX = Date Code. XXXXX = Date Code and Vendor Code.

**SOT-23-5**

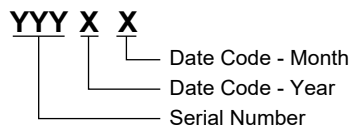

**SOIC-8/MSOP-8**

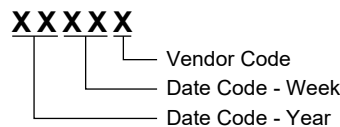

Green (RoHS & HSF): SG Micro Corp defines "Green" to mean Pb-Free (RoHS compatible) and free of halogen substances. If you have additional comments or questions, please contact your SGMICRO representative directly.

**ABSOLUTE MAXIMUM RATINGS**

- Supply Voltage.....6V
- Signal Input Terminals, Voltage  
..... (-V<sub>S</sub>) - 0.3V to (+V<sub>S</sub>) + 0.3V
- Signal Input Terminals, Current ..... ±10mA
- Output Short-Circuit..... Continuous
- Junction Temperature.....+150°C
- Storage Temperature Range .....-65°C to +150°C
- Lead Temperature (Soldering, 10s).....+260°C
- ESD Susceptibility
- HBM..... 8000V
- MM..... 400V
- CDM ..... 1000V

**RECOMMENDED OPERATING CONDITIONS**

- Supply Voltage Range .....2.2V to 5.5V
- Operating Temperature Range.....-40°C to +125°C

**OVERSTRESS CAUTION**

Stresses beyond those listed in Absolute Maximum Ratings may cause permanent damage to the device. Exposure to absolute maximum rating conditions for extended periods may affect reliability. Functional operation of the device at any conditions beyond those indicated in the Recommended Operating Conditions section is not implied.

**ESD SENSITIVITY CAUTION**

This integrated circuit can be damaged if ESD protections are not considered carefully. SGMICRO recommends that all integrated circuits be handled with appropriate precautions. Failure to observe proper handling and installation procedures can cause damage. ESD damage can range from subtle performance degradation to complete device failure. Precision integrated circuits may be more susceptible to damage because even small parametric changes could cause the device not to meet the published specifications.

**DISCLAIMER**

SG Micro Corp reserves the right to make any change in circuit design, or specifications without prior notice.

**PIN CONFIGURATIONS**

**SGM8965-1 (TOP VIEW)**

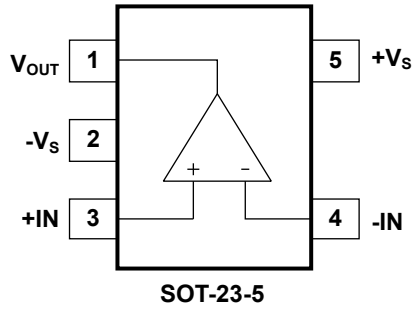

**SGM8965-1 (TOP VIEW)**

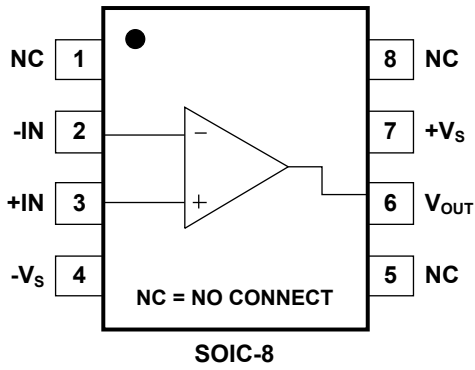

**SGM8965-2 (TOP VIEW)**

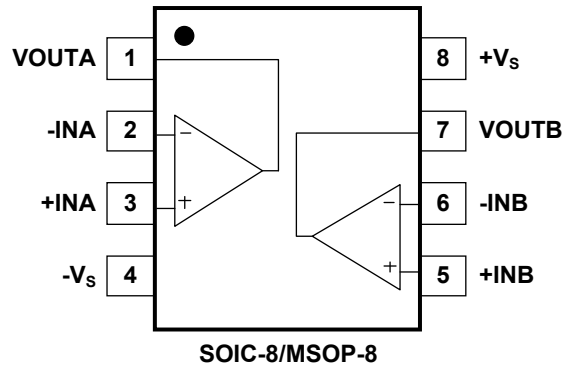

**ELECTRICAL CHARACTERISTICS**

( $T_A = +25^\circ\text{C}$ ,  $V_S = 2.2\text{V to } 5.5\text{V}$ ,  $V_{CM} = V_S/2$ ,  $V_{OUT} = V_S/2$  and  $R_L = 10\text{k}\Omega$  connected to  $V_S/2$ , unless otherwise noted.)

PARAMETER	SYMBOL	CONDITIONS	MIN	TYP	MAX	UNIT
<b>Input Characteristics</b>						
Input Offset Voltage	$V_{OS}$			80	250	$\mu\text{V}$
Input Offset Voltage Drift	$\Delta V_{OS}/\Delta T$	$-40^\circ\text{C} \leq T_A \leq +125^\circ\text{C}$		1.2		$\mu\text{V}/^\circ\text{C}$
Power Supply Rejection Ratio	PSRR	$V_S = 2.2\text{V to } 5.5\text{V}$ , $-40^\circ\text{C} \leq T_A \leq +125^\circ\text{C}$		6	90	$\mu\text{V}/\text{V}$
Input Bias Current	$I_B$			0.5		$\text{pA}$
Input Common Mode Voltage Range	$V_{CM}$		$(-V_S) - 0.1$		$(+V_S) + 0.1$	$\text{V}$
Common Mode Rejection Ratio	CMRR	$(-V_S) - 0.1\text{V} \leq V_{CM} \leq (+V_S) + 0.1\text{V}$ , $V_S = 5.5\text{V}$ , $-40^\circ\text{C} \leq T_A \leq +125^\circ\text{C}$	82	100		$\text{dB}$
Open-Loop Voltage Gain	$A_{OL}$	$R_L = 10\text{k}\Omega$ , $(-V_S) + 0.1\text{V} < V_O < (+V_S) - 0.1\text{V}$ , $-40^\circ\text{C} \leq T_A \leq +125^\circ\text{C}$	94	115		$\text{dB}$
		$R_L = 600\Omega$ , $(-V_S) + 0.2\text{V} < V_O < (+V_S) - 0.2\text{V}$ $-40^\circ\text{C} \leq T_A \leq +125^\circ\text{C}$	94	105		
		$-40^\circ\text{C} \leq T_A \leq +125^\circ\text{C}$	90			
<b>Output Characteristics</b>						
Output Voltage Swing from Rail		$R_L = 10\text{k}\Omega$ , $V_S = 5.5\text{V}$ , $-40^\circ\text{C} \leq T_A \leq +125^\circ\text{C}$		8	22	$\text{mV}$
Short-Circuit Current	$I_{SC}$	$V_S = 5\text{V}$		70		$\text{mA}$
Open-Loop Output Impedance		$f = 1\text{MHz}$ , $I_O = 0$		26		$\Omega$
<b>Power Supply</b>						
Operating Voltage Range	$V_S$		2.2		5.5	$\text{V}$
Quiescent Current/Amplifier	$I_Q$	$I_O = 0$		5.3	6.6	$\text{mA}$
		$-40^\circ\text{C} \leq T_A \leq +125^\circ\text{C}$			6.9	
<b>Dynamic Performance</b>						
Gain-Bandwidth Product	GBP	$V_S = 5\text{V}$		50		$\text{MHz}$
Slew Rate	SR	$V_S = 5\text{V}$ , $G = +1$		30		$\text{V}/\mu\text{s}$
Settling Time to 0.1%	$t_s$	$V_S = 5\text{V}$ , 4V Step, $G = +4$		220		$\text{ns}$
Settling Time to 0.01%		$V_S = 5\text{V}$ , 4V Step, $G = +4$		300		$\text{ns}$
Overload Recovery Time		$V_S = 5\text{V}$ , $V_{IN} \times \text{Gain} > V_S$		< 0.1		$\mu\text{s}$
Total Harmonic Distortion + Noise <sup>(1)</sup>	THD+N	$V_S = 5\text{V}$ , $R_L = 600\Omega$ , $V_O = 4V_{PP}$ , $G = +1$ , $f = 1\text{kHz}$		0.00015		$\%$
<b>Noise Performance</b>						
Input Voltage Noise		$f = 0.1\text{Hz to } 10\text{Hz}$		5		$\mu\text{V}_{PP}$
Input Voltage Noise Density	$e_n$	$f = 100\text{kHz}$		4.5		$\text{nV}/\sqrt{\text{Hz}}$
Input Current Noise Density	$i_n$	$f = 10\text{kHz}$		125		$\text{fA}/\sqrt{\text{Hz}}$

NOTE: 1. 3rd-order filter; -3dB bandwidth: 80kHz.

**TYPICAL PERFORMANCE CHARACTERISTICS**

At  $T_A = +25^\circ\text{C}$ ,  $V_S = 5\text{V}$  and  $C_L = 0\text{pF}$ , unless otherwise noted.

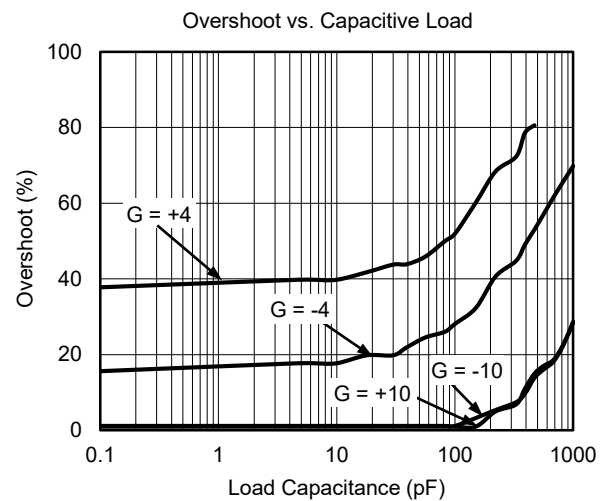
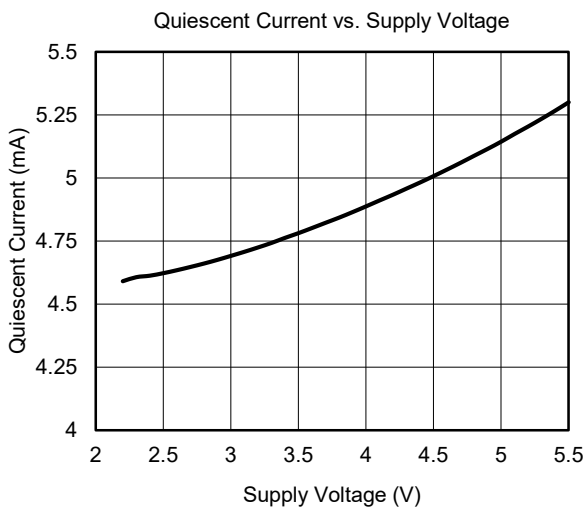
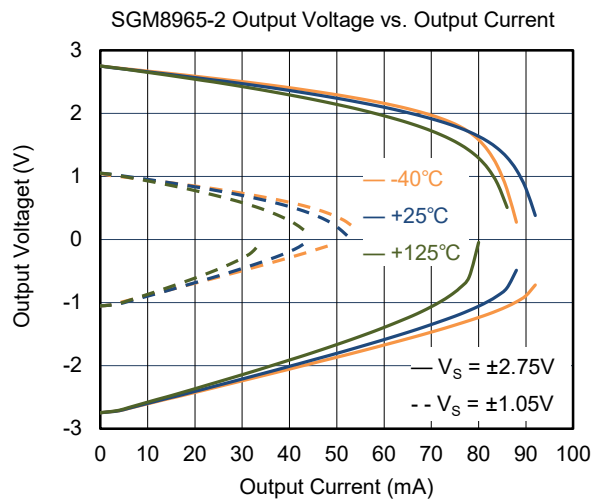
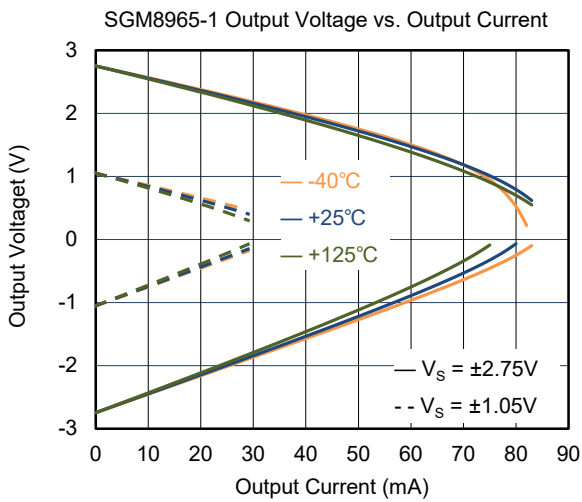
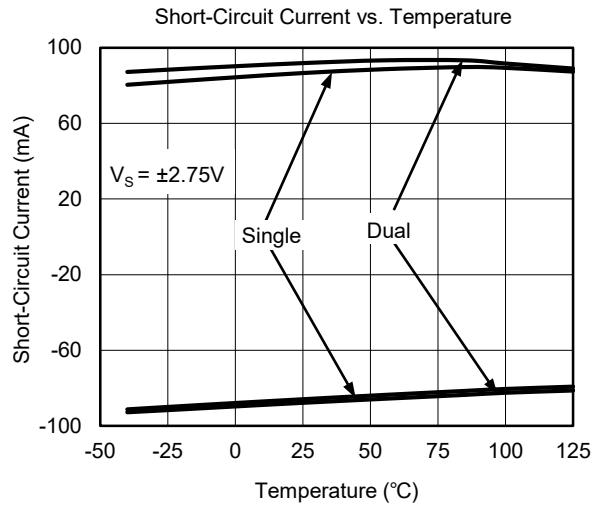
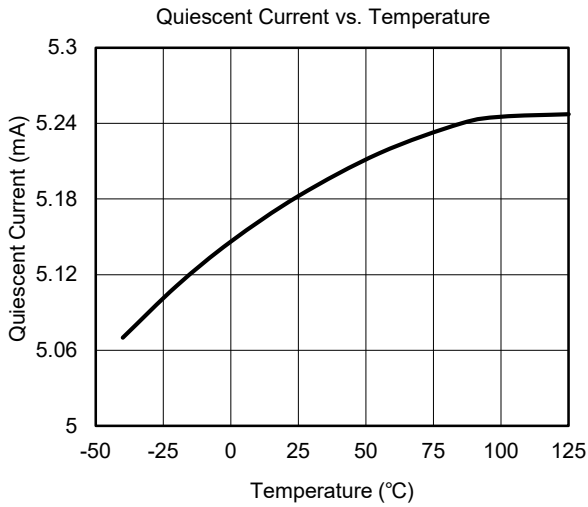

**TYPICAL PERFORMANCE CHARACTERISTICS (continued)**

At  $T_A = +25^\circ\text{C}$ ,  $V_S = 5\text{V}$  and  $C_L = 0\text{pF}$ , unless otherwise noted.

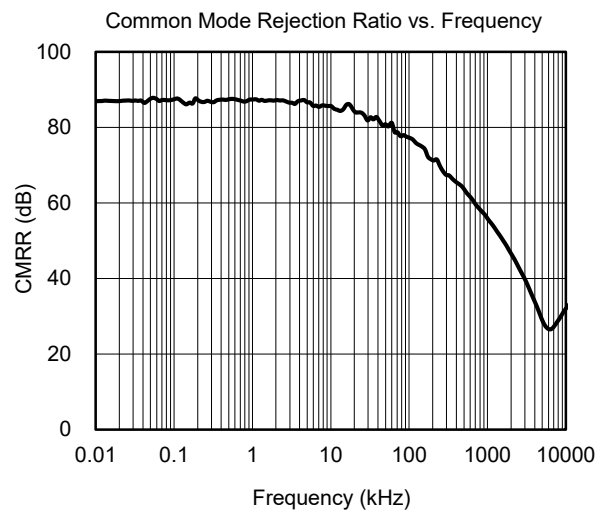
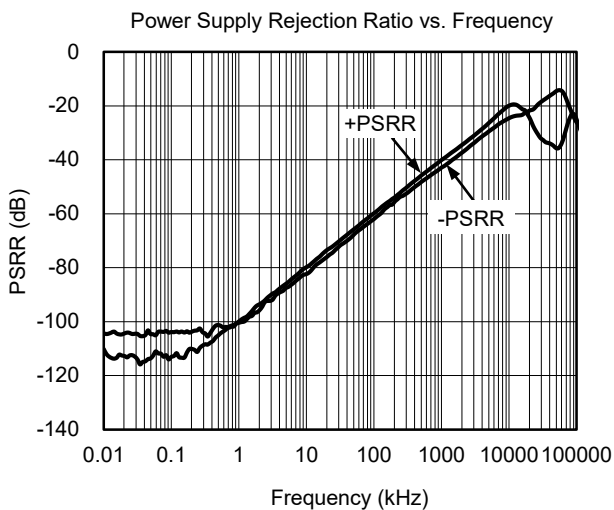
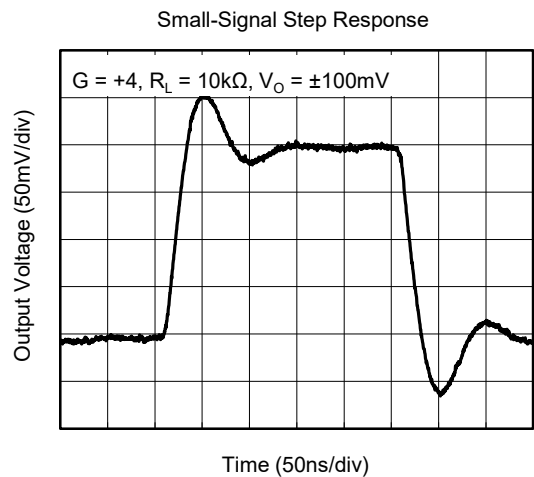
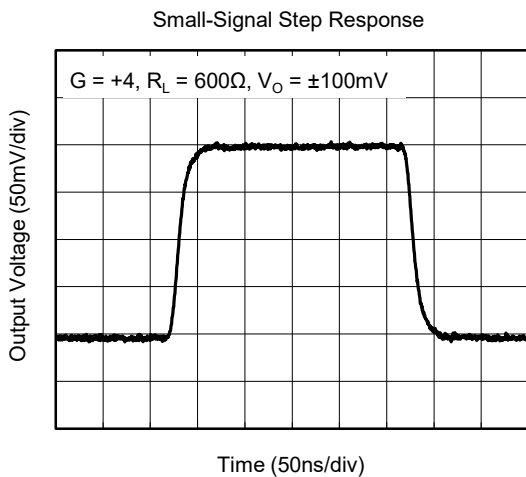
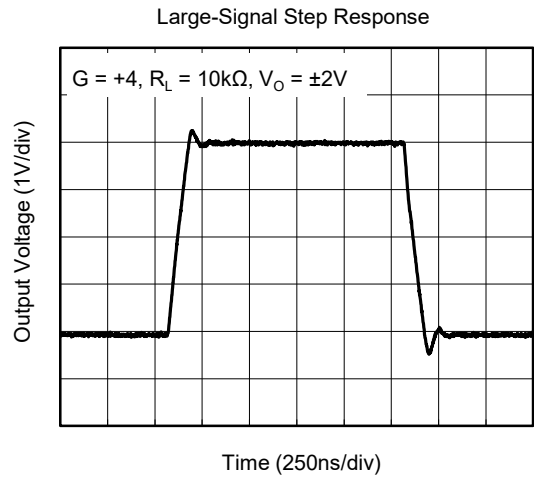
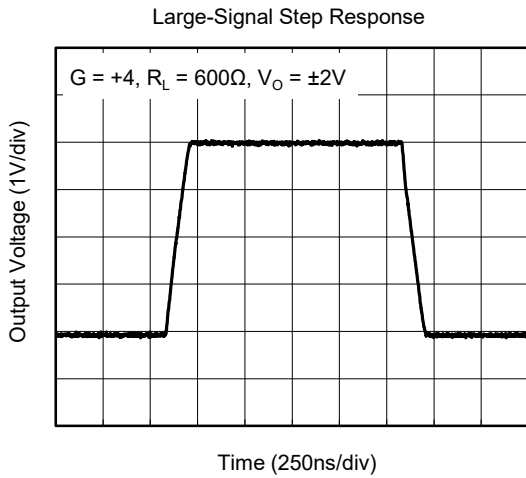

**TYPICAL PERFORMANCE CHARACTERISTICS (continued)**

At  $T_A = +25^\circ\text{C}$ ,  $V_S = 5\text{V}$  and  $C_L = 0\text{pF}$ , unless otherwise noted.

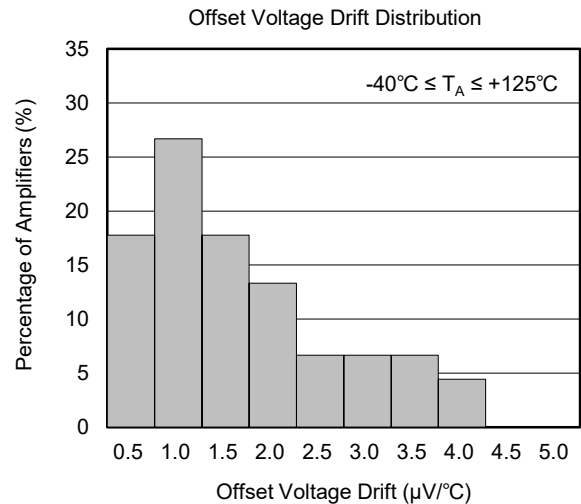
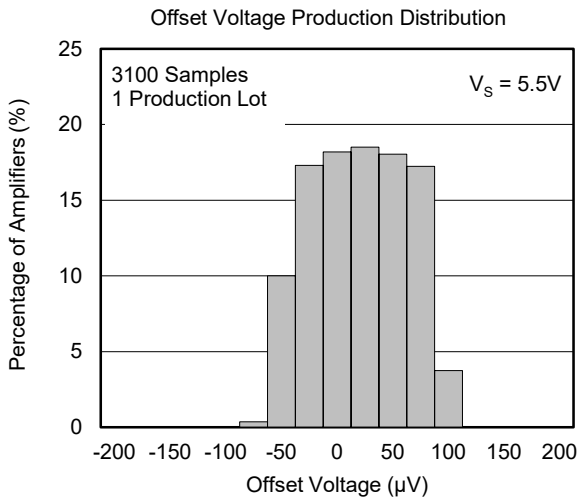
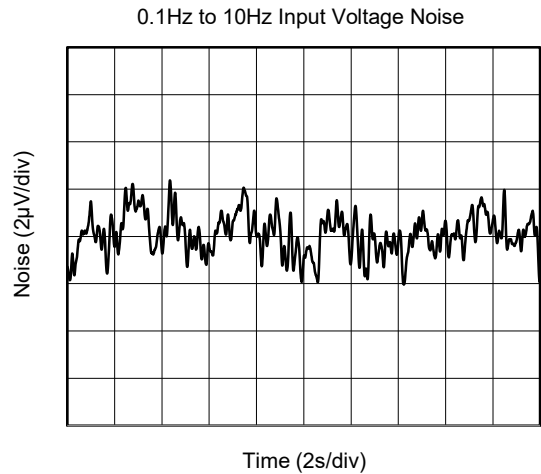
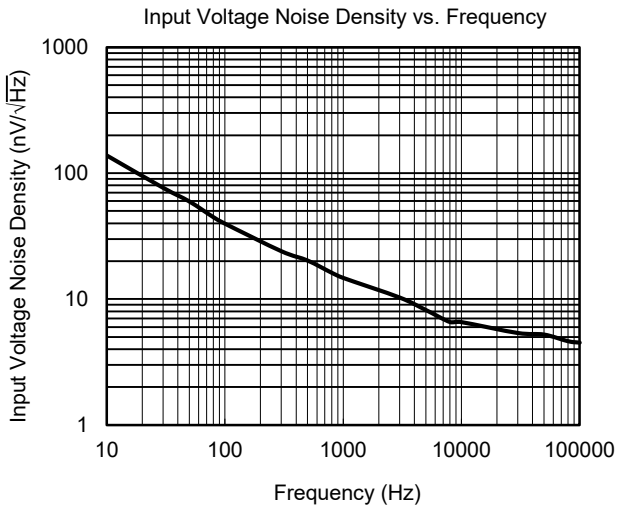
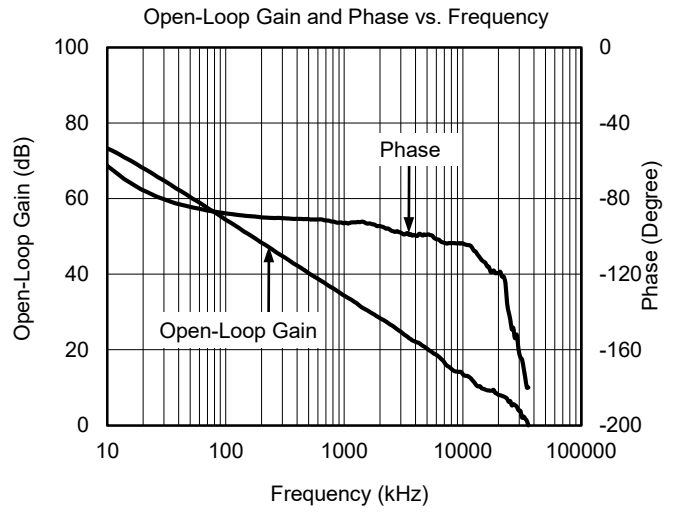
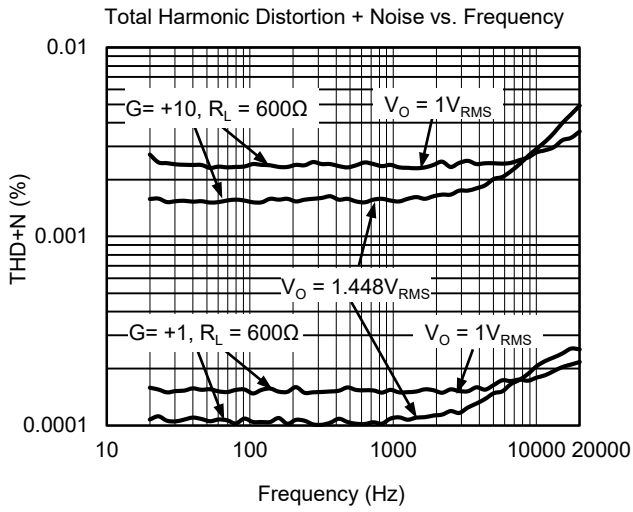

## **REVISION HISTORY**

NOTE: Page numbers for previous revisions may differ from page numbers in the current version.

### **Changes from Original (DECEMBER 2016) to REV.A**

**Page**

---

Changed from product preview to production data.....	All
--	-----

---



# PACKAGE INFORMATION

## PACKAGE OUTLINE DIMENSIONS

### SOT-23-5

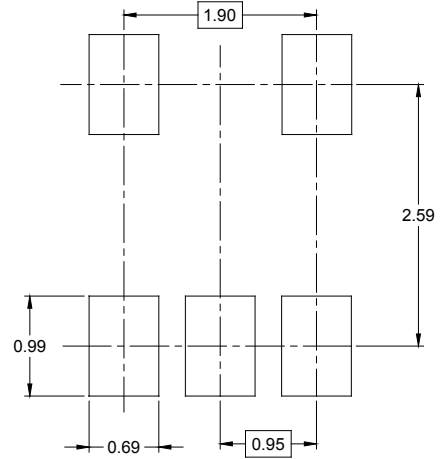
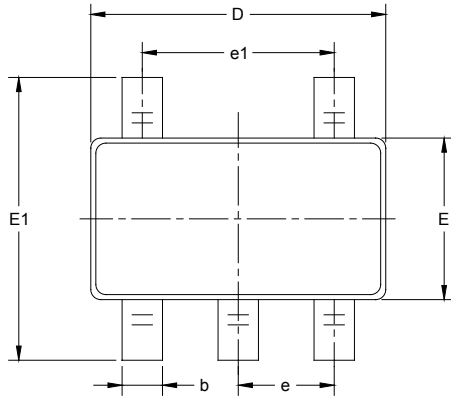

RECOMMENDED LAND PATTERN (Unit: mm)



Symbol	Dimensions In Millimeters		Dimensions In Inches	
	MIN	MAX	MIN	MAX
A	1.050	1.250	0.041	0.049
A1	0.000	0.100	0.000	0.004
A2	1.050	1.150	0.041	0.045
b	0.300	0.500	0.012	0.020
c	0.100	0.200	0.004	0.008
D	2.820	3.020	0.111	0.119
E	1.500	1.700	0.059	0.067
E1	2.650	2.950	0.104	0.116
e	0.950 BSC		0.037 BSC	
e1	1.900 BSC		0.075 BSC	
L	0.300	0.600	0.012	0.024
$\theta$	0°	8°	0°	8°

PACKAGE OUTLINE DIMENSIONS

SOIC-8

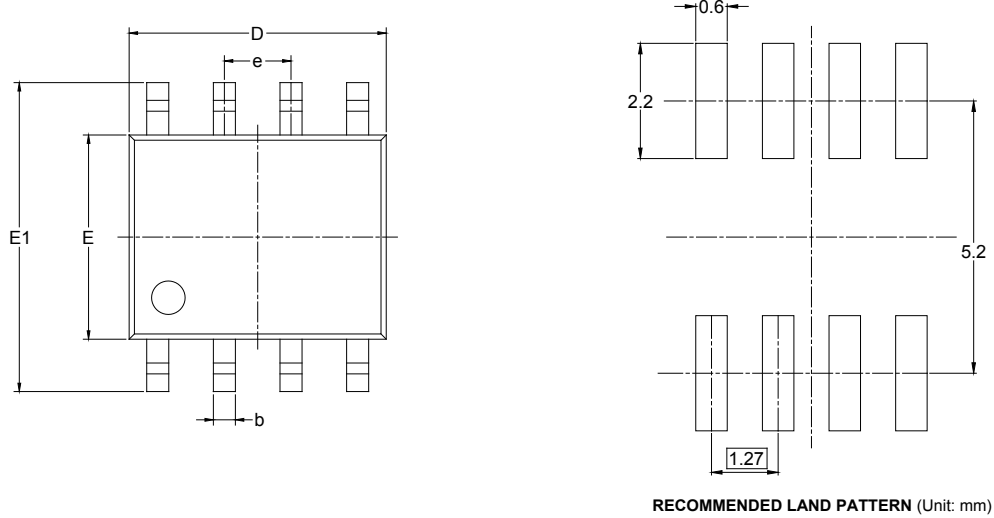

Symbol	Dimensions In Millimeters		Dimensions In Inches	
	MIN	MAX	MIN	MAX
A	1.350	1.750	0.053	0.069
A1	0.100	0.250	0.004	0.010
A2	1.350	1.550	0.053	0.061
b	0.330	0.510	0.013	0.020
c	0.170	0.250	0.006	0.010
D	4.700	5.100	0.185	0.200
E	3.800	4.000	0.150	0.157
E1	5.800	6.200	0.228	0.244
e	1.27 BSC		0.050 BSC	
L	0.400	1.270	0.016	0.050
$\theta$	0°	8°	0°	8°

PACKAGE OUTLINE DIMENSIONS

MSOP-8

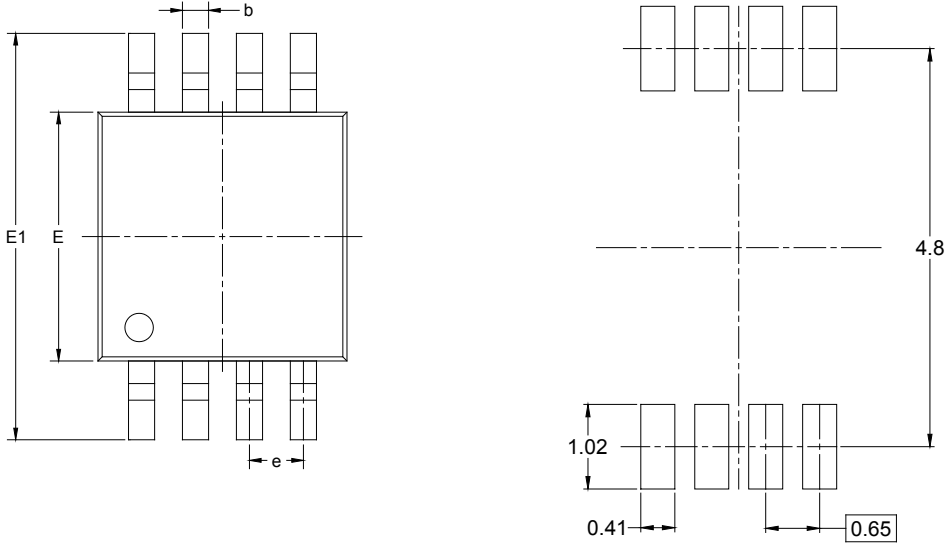

RECOMMENDED LAND PATTERN (Unit: mm)

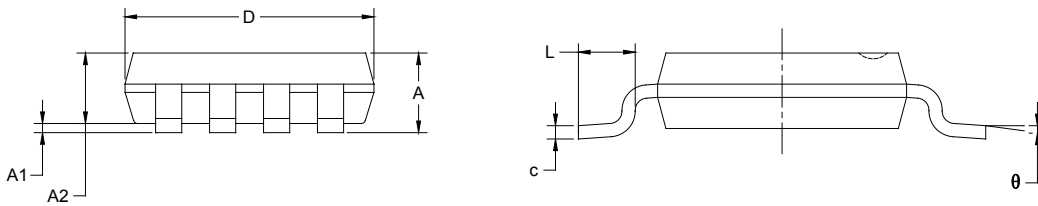

Symbol	Dimensions In Millimeters		Dimensions In Inches	
	MIN	MAX	MIN	MAX
A	0.820	1.100	0.032	0.043
A1	0.020	0.150	0.001	0.006
A2	0.750	0.950	0.030	0.037
b	0.250	0.380	0.010	0.015
c	0.090	0.230	0.004	0.009
D	2.900	3.100	0.114	0.122
E	2.900	3.100	0.114	0.122
E1	4.750	5.050	0.187	0.199
e	0.650 BSC		0.026 BSC	
L	0.400	0.800	0.016	0.031
θ	0°	6°	0°	6°

# PACKAGE INFORMATION

## TAPE AND REEL INFORMATION

### REEL DIMENSIONS



### TAPE DIMENSIONS



NOTE: The picture is only for reference. Please make the object as the standard.

### KEY PARAMETER LIST OF TAPE AND REEL

Package Type	Reel Diameter	Reel Width W1 (mm)	A0 (mm)	B0 (mm)	K0 (mm)	P0 (mm)	P1 (mm)	P2 (mm)	W (mm)	Pin1 Quadrant
SOT-23-5	7"	9.5	3.20	3.20	1.40	4.0	4.0	2.0	8.0	Q3
SOIC-8	13"	12.4	6.40	5.40	2.10	4.0	8.0	2.0	12.0	Q1
MSOP-8	13"	12.4	5.20	3.30	1.50	4.0	8.0	2.0	12.0	Q1

DD0001

# PACKAGE INFORMATION

## CARTON BOX DIMENSIONS



NOTE: The picture is only for reference. Please make the object as the standard.

## KEY PARAMETER LIST OF CARTON BOX

Reel Type	Length (mm)	Width (mm)	Height (mm)	Pizza/Carton
7" (Option)	368	227	224	8
7"	442	410	224	18
13"	386	280	370	5

DD0002

单击下面可查看定价，库存，交付和生命周期等信息

[>>SGMICRO\(圣邦微电子\)](#)