

GENERAL DESCRIPTION

The SGM2205 is a high voltage, low noise and low dropout voltage linear regulator. It is capable of supplying 800mA output current with typical dropout voltage of only 450mV. The operating input voltage range is from 2.5V to 20V.

Other features include logic-controlled shutdown mode, short-circuit current limit and thermal shutdown protection. The SGM2205 has automatic discharge function to quickly discharge V_{OUT} in the disabled status.

The SGM2205 is available in Green SOT-89-3, SOT-223-3, SOIC-8, TDFN-3x3-8L and TO-263-5B packages. It operates over an operating temperature range of -40°C to +125°C.

FEATURES

- **Wide Operating Input Voltage Range: 2.5V to 20V**
- **Fixed Outputs of 1.8V, 2.5V, 3.0V, 3.3V, 3.6V, 4.2V, 5.0V and 12V**
- **Adjustable Output from 1.8V to 15V**
- **Output Voltage Accuracy: $\pm 1\%$ at +25°C**
- **Low Dropout Voltage: 450mV (TYP) at 800mA**
- **Current Limiting and Thermal Protection**
- **Excellent Load and Line Transient Responses**
- **With Output Automatic Discharge**
- **No-Load Stability**
- **-40°C to +125°C Operating Temperature Range**
- **Available in Green SOT-89-3, SOT-223-3, SOIC-8, TDFN-3x3-8L and TO-263-5B Packages**

APPLICATIONS

- Cellular Telephones
- Palmtop Computers
- High-Efficiency Linear Power Supplies
- Portable Equipment
- Battery-Powered Systems

TYPICAL APPLICATIONS

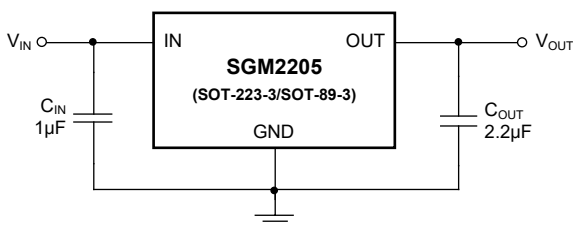

Figure 1. Fixed Voltage Typical Application Circuit

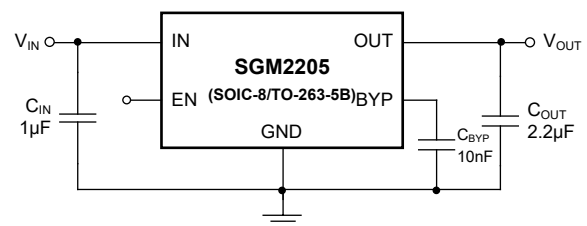

Figure 2. Low Noise Regulator (Fixed Voltage Version)

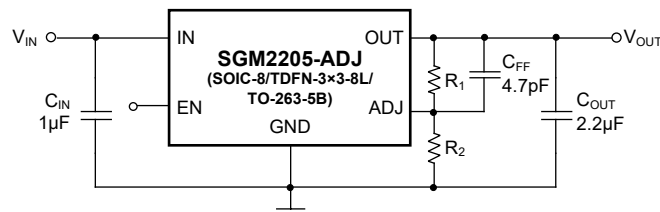

Figure 3. Low Noise Regulator (Adjustable Voltage Version)

PACKAGE/ORDERING INFORMATION

MODEL	PACKAGE DESCRIPTION	SPECIFIED TEMPERATURE RANGE	ORDERING NUMBER	PACKAGE MARKING	PACKING OPTION
SGM2205-1.8	SOT-89-3	-40°C to +125°C	SGM2205-1.8XK3G/TR	MJFX	Tape and Reel, 1000
SGM2205-2.5	SOT-89-3	-40°C to +125°C	SGM2205-2.5XK3G/TR	RA4XX	Tape and Reel, 1000
SGM2205-3.3	SOT-89-3	-40°C to +125°C	SGM2205-3.3XK3G/TR	RA5XX	Tape and Reel, 1000
SGM2205-4.2	SOT-89-3	-40°C to +125°C	SGM2205-4.2XK3G/TR	M34XX	Tape and Reel, 1000
SGM2205-5.0	SOT-89-3	-40°C to +125°C	SGM2205-5.0XK3G/TR	RA6XX	Tape and Reel, 1000
SGM2205-1.8	SOT-223-3	-40°C to +125°C	SGM2205-1.8XKC3G/TR	M86 XXXXX	Tape and Reel, 2500
SGM2205-2.5	SOT-223-3	-40°C to +125°C	SGM2205-2.5XKC3G/TR	M87 XXXXX	Tape and Reel, 2500
SGM2205-3.0	SOT-223-3	-40°C to +125°C	SGM2205-3.0XKC3G/TR	M89 XXXXX	Tape and Reel, 2500
SGM2205-3.3	SOT-223-3	-40°C to +125°C	SGM2205-3.3XKC3G/TR	M8A XXXXX	Tape and Reel, 2500
SGM2205-3.6	SOT-223-3	-40°C to +125°C	SGM2205-3.6XKC3G/TR	M8B XXXXX	Tape and Reel, 2500
SGM2205-4.2	SOT-223-3	-40°C to +125°C	SGM2205-4.2XKC3G/TR	GP4 XXXXX	Tape and Reel, 2500
SGM2205-5.0	SOT-223-3	-40°C to +125°C	SGM2205-5.0XKC3G/TR	M8C XXXXX	Tape and Reel, 2500
SGM2205-12	SOT-223-3	-40°C to +125°C	SGM2205-12XKC3G/TR	M8D XXXXX	Tape and Reel, 2500
SGM2205-1.8	SOIC-8	-40°C to +125°C	SGM2205-1.8XS8G/TR	SGM MM2XS8 XXXXX	Tape and Reel, 4000
SGM2205-2.5	SOIC-8	-40°C to +125°C	SGM2205-2.5XS8G/TR	SGM MM3XS8 XXXXX	Tape and Reel, 4000
SGM2205-3.0	SOIC-8	-40°C to +125°C	SGM2205-3.0XS8G/TR	SGM MM4XS8 XXXXX	Tape and Reel, 4000
SGM2205-3.3	SOIC-8	-40°C to +125°C	SGM2205-3.3XS8G/TR	SGM MM5XS8 XXXXX	Tape and Reel, 4000
SGM2205-3.6	SOIC-8	-40°C to +125°C	SGM2205-3.6XS8G/TR	SGM MM6XS8 XXXXX	Tape and Reel, 4000
SGM2205-4.2	SOIC-8	-40°C to +125°C	SGM2205-4.2XS8G/TR	SGM M33XS8 XXXXX	Tape and Reel, 4000
SGM2205-5.0	SOIC-8	-40°C to +125°C	SGM2205-5.0XS8G/TR	SGM MM7XS8 XXXXX	Tape and Reel, 4000
SGM2205-12	SOIC-8	-40°C to +125°C	SGM2205-12XS8G/TR	SGM MM8XS8 XXXXX	Tape and Reel, 4000
SGM2205-ADJ	SOIC-8	-40°C to +125°C	SGM2205-ADJXS8G/TR	SGM 2205ADJXS8 XXXXX	Tape and Reel, 4000

PACKAGE/ORDERING INFORMATION (continued)

MODEL	PACKAGE DESCRIPTION	SPECIFIED TEMPERATURE RANGE	ORDERING NUMBER	PACKAGE MARKING	PACKING OPTION
SGM2205-1.8	TDFN-3×3-8L	-40°C to +125°C	SGM2205-1.8XTDB8G/TR	SGM MP6DB XXXXX	Tape and Reel, 4000
SGM2205-3.3	TDFN-3×3-8L	-40°C to +125°C	SGM2205-3.3XTDB8G/TR	SGM CABDB XXXXX	Tape and Reel, 4000
SGM2205-5.0	TDFN-3×3-8L	-40°C to +125°C	SGM2205-5.0XTDB8G/TR	SGM CACDB XXXXX	Tape and Reel, 4000
SGM2205-ADJ	TDFN-3×3-8L	-40°C to +125°C	SGM2205-ADJXTDB8G/TR	SGM R1DB XXXXX	Tape and Reel, 4000
SGM2205-1.8	TO-263-5B	-40°C to +125°C	SGM2205-1.8XO5G/TR	SGMMA XO5 XXXXX	Tape and Reel, 800
SGM2205-2.5	TO-263-5B	-40°C to +125°C	SGM2205-2.5XO5G/TR	SGMMB XO5 XXXXX	Tape and Reel, 800
SGM2205-3.0	TO-263-5B	-40°C to +125°C	SGM2205-3.0XO5G/TR	SGMMC XO5 XXXXX	Tape and Reel, 800
SGM2205-3.3	TO-263-5B	-40°C to +125°C	SGM2205-3.3XO5G/TR	SGMMD XO5 XXXXX	Tape and Reel, 800
SGM2205-3.6	TO-263-5B	-40°C to +125°C	SGM2205-3.6XO5G/TR	SGMME XO5 XXXXX	Tape and Reel, 800
SGM2205-4.2	TO-263-5B	-40°C to +125°C	SGM2205-4.2XO5G/TR	SGMN2 XO5 XXXXX	Tape and Reel, 800
SGM2205-5.0	TO-263-5B	-40°C to +125°C	SGM2205-5.0XO5G/TR	SGMMF XO5 XXXXX	Tape and Reel, 800
SGM2205-12	TO-263-5B	-40°C to +125°C	SGM2205-12XO5G/TR	SGMN0 XO5 XXXXX	Tape and Reel, 800
SGM2205-ADJ	TO-263-5B	-40°C to +125°C	SGM2205-ADJXO5G/TR	SGM2205ADJ XO5 XXXXX	Tape and Reel, 800

MARKING INFORMATION

NOTE: XX = Date Code. XXXXX = Date Code, Trace Code and Vendor Code.

SOT-89-3

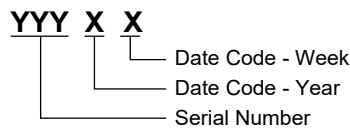

SOT-223-3/SOIC-8/TDFN-3×3-8L/TO-263-5B

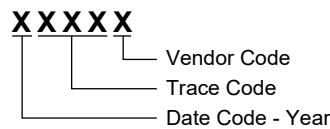

Green (RoHS & HSF): SG Micro Corp defines "Green" to mean Pb-Free (RoHS compatible) and free of halogen substances. If you have additional comments or questions, please contact your SGMICRO representative directly.

ABSOLUTE MAXIMUM RATINGS

Supply Voltage Range, V_{IN}	-24V to +24V
OUT to GND ($V_{IN} \geq 0V$).....	-0.3V to $\text{Min}(V_{IN} + 5.5V, +24V)$
EN to GND ($V_{IN} \geq 0V$).....	-0.3V to +24V
ADJ, BYP to GND ($V_{IN} \geq 0V$).....	-0.3V to +6V
Power Dissipation, $P_D @ T_J = +25^\circ C$	
SOT-89-3.....	1.66W
SOT-223-3.....	1.32W
SOIC-8.....	1.32W
TDFN-3x3-8L.....	1.36W
TO-263-5B.....	2.78W
Package Thermal Resistance	
SOT-89-3, θ_{JA}	75°C/W
SOT-89-3, θ_{JC}	84°C/W
SOT-223-3, θ_{JA}	95°C/W
SOT-223-3, θ_{JC}	50°C/W
SOIC-8, θ_{JA}	95°C/W
SOIC-8, θ_{JC}	41°C/W
TDFN-3x3-8L, θ_{JA}	92°C/W
TDFN-3x3-8L, θ_{JC}	46°C/W
TO-263-5B, θ_{JA}	45°C/W
TO-263-5B, θ_{JC}	42°C/W
Junction Temperature.....	+150°C
Storage Temperature Range.....	-65°C to +150°C
Lead Temperature (Soldering, 10s).....	+260°C
ESD Susceptibility	
HBM.....	6000V
CDM.....	1000V

RECOMMENDED OPERATING CONDITIONS

Input Voltage Range, V_{IN}	2.5V to 20V
Adjustable Output Voltage Range.....	1.8V to 15V
Input Effective Capacitance, C_{IN}	0.5µF (MIN)
Output Effective Capacitance, C_{OUT}	1µF to 10µF
C_{BYP} Effective Capacitance.....	10nF
C_{FF} Effective Capacitance.....	4.7pF
Operating Junction Temperature Range.....	-40°C to +125°C

OVERSTRESS CAUTION

Stresses beyond those listed in Absolute Maximum Ratings may cause permanent damage to the device. Exposure to absolute maximum rating conditions for extended periods may affect reliability. Functional operation of the device at any conditions beyond those indicated in the Recommended Operating Conditions section is not implied.

ESD SENSITIVITY CAUTION

This integrated circuit can be damaged if ESD protections are not considered carefully. SGMICRO recommends that all integrated circuits be handled with appropriate precautions. Failure to observe proper handling and installation procedures can cause damage. ESD damage can range from subtle performance degradation to complete device failure. Precision integrated circuits may be more susceptible to damage because even small parametric changes could cause the device not to meet the published specifications.

DISCLAIMER

SG Micro Corp reserves the right to make any change in circuit design, or specifications without prior notice.

PIN CONFIGURATIONS

SGM2205-Fixed Output (TOP VIEW)

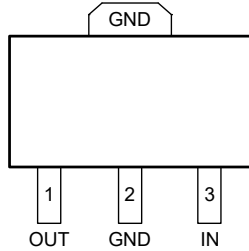

SOT-89-3

SGM2205-Fixed Output (TOP VIEW)

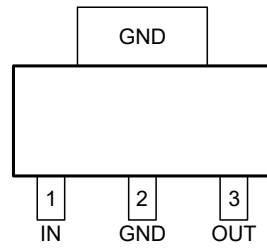

SOT-223-3

SGM2205-Fixed Output (TOP VIEW)

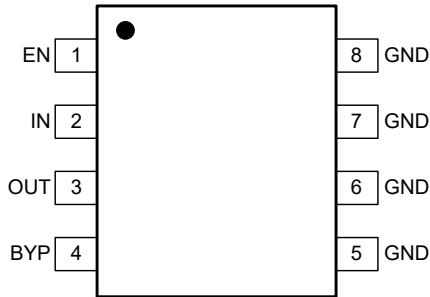

SOIC-8

SGM2205-ADJ (TOP VIEW)

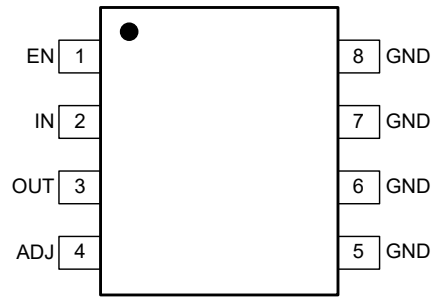

SOIC-8

SGM2205-Fixed Output (TOP VIEW)

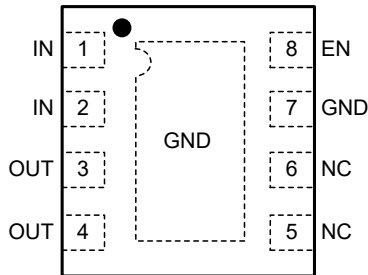

TDFN-3x3-8L

SGM2205-ADJ (TOP VIEW)

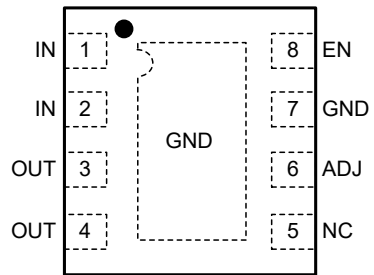

TDFN-3x3-8L

SGM2205-Fixed Output (TOP VIEW)

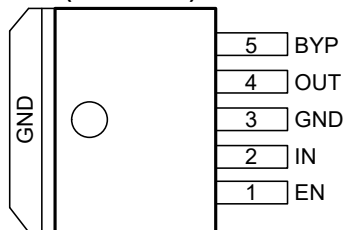

TO-263-5B

SGM2205-ADJ (TOP VIEW)

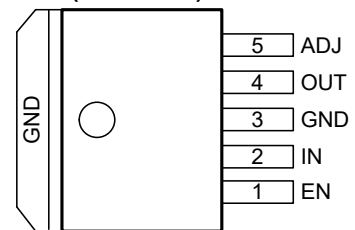

TO-263-5B

PIN DESCRIPTION

PIN					NAME	FUNCTION
SOT-89-3	SOT-223-3	SOIC-8	TDFN-3×3-8L	TO-263-5B		
1	3	3	3, 4	4	OUT	Regulator Output Pin. It is recommended to use an output capacitor with effective capacitance in the range of 1μF to 10μF to ensure stability. Pins 3 and 4 must be tied together for TDFN-3×3-8L package.
2	2	5-8	7	3	GND	Ground. Pins 5 to 8 are internally connected for SOIC-8 package.
3	1	2	1, 2	2	IN	Input Supply Voltage Pin. It is recommended to use a 1μF or larger ceramic capacitor from IN pin to ground to get good power supply decoupling.
–	–	1	8	1	EN	Enable Pin. Drive EN high to turn on the regulator. Drive EN low to turn off the regulator.
–	–	4	–	5	BYP	Reference Bypass Pin (fixed voltage version only). Bypass with an external capacitor C _{BYP} can reduce output noise to very low level.
			6		ADJ	Feedback Voltage Input Pin (adjustable voltage version only). Connect this pin to the midpoint of an external resistor divider to adjust the output voltage. Place the resistors as close as possible to this pin.
–	–	–	5	–	NC	No Connection.
–	–	–	6	–	NC	No Connection (fixed voltage version only).
–	–	–	Exposed Pad	–	–	Exposed Pad. Connect it to GND internally. Connect it to a large ground plane to maximize thermal performance; this pad is not an electrical connection point.

ELECTRICAL CHARACTERISTICS

(V_{IN} = V_{OUT(NOM)} + 1V, I_{OUT} = 0.1mA, C_{OUT} = 2.2μF, T_J = -40°C to +125°C, typical values are at T_J = +25°C, unless otherwise noted.)

PARAMETER	SYMBOL	CONDITIONS	MIN	TYP	MAX	UNITS
Input Voltage Range	V _{IN}	T _J = +25°C	2.5		20	V
Output Voltage Accuracy	V _{OUT}	I _{OUT} = 0.1mA, T _J = +25°C	-1		1	%
		I _{OUT} = 0.1mA to 800mA	-2		2	
Reference Voltage	V _{REF}	T _J = +25°C	1.188	1.2	1.212	V
			1.176		1.224	
Line Regulation	$\frac{\Delta V_{OUT}}{\Delta V_{IN} \times V_{OUT}}$	V _{IN} = (V _{OUT(NOM)} + 1V) to 20V, T _J = +25°C		0.0003	0.003	%V
		V _{IN} = (V _{OUT(NOM)} + 1V) to 20V			0.005	
Load Regulation	$\frac{\Delta V_{OUT}}{V_{OUT}}$	I _{OUT} = 0.1mA to 800mA, T _J = +25°C		0.1	0.3	%
		I _{OUT} = 0.1mA to 800mA			0.4	
Dropout Voltage ⁽¹⁾	V _{DROP}	V _{OUT} = 3.3V, I _{OUT} = 50mA, T _J = +25°C		30	38	mV
		V _{OUT} = 3.3V, I _{OUT} = 50mA			55	
		V _{OUT} = 3.3V, I _{OUT} = 200mA, T _J = +25°C		115	150	
		V _{OUT} = 3.3V, I _{OUT} = 200mA			210	
		V _{OUT} = 3.3V, I _{OUT} = 800mA, T _J = +25°C		450	610	
		V _{OUT} = 3.3V, I _{OUT} = 800mA			850	
Output Current Limit	I _{LIMIT}	V _{OUT} = 93% × V _{OUT(NOM)} , T _J = +25°C	820	1100		mA
Short-Circuit Current	I _{SHORT}	V _{IN} = V _{EN} = 3V, V _{OUT} = 0V		230		mA
Ground Pin Current	I _Q	V _{EN} ≥ 1.2V, no load, T _J = +25°C		80	104	μA
		V _{EN} ≥ 1.2V, no load			112	
		V _{EN} ≥ 1.2V, I _{OUT} = 0.1mA, T _J = +25°C		80	104	
		V _{EN} ≥ 1.2V, I _{OUT} = 0.1mA			112	
		V _{EN} ≥ 1.2V, I _{OUT} = 50mA, T _J = +25°C		220	280	
		V _{EN} ≥ 1.2V, I _{OUT} = 50mA			290	
		V _{EN} ≥ 1.2V, I _{OUT} = 800mA, T _J = +25°C		1950	2250	
		V _{EN} ≥ 1.2V, I _{OUT} = 800mA			2350	
Ground Pin Quiescent Current	I _{Q(GND)}	V _{EN} ≤ 0.4V (shutdown), T _J = +25°C		2.7	3.5	μA
		V _{EN} ≤ 0.4V (shutdown)			6.8	
Enable Input Logic Voltage	V _{EN}	V _{EN} = Logic low (regulator shutdown)			0.4	V
		V _{EN} = Logic high (regulator enabled)	1.2			
Enable Input Current	I _{ENL}	V _{EN} ≤ 0.4V			1	μA
	I _{ENH}	V _{EN} = V _{IN}			1	
Power Supply Rejection Ratio	PSRR	f = 1kHz, V _{OUT} = 2.5V, I _{OUT} = 50mA		75		dB
Output Voltage Noise	e _n	f = 1kHz, V _{OUT} = 2.5V, I _{OUT} = 50mA, C _{OUT} = 2.2μF		400		nV/√Hz
		f = 1kHz, V _{OUT} = 2.5V, I _{OUT} = 50mA, C _{OUT} = 2.2μF, C _{BYP} = 10nF		240		
Output Voltage Temperature Coefficient	$\frac{\Delta V_{OUT}}{\Delta T_J \times V_{OUT}}$			40		ppm/°C
Thermal Shutdown Temperature	T _{SHDN}			155		°C
Thermal Shutdown Hysteresis	ΔT _{SHDN}			25		°C

NOTE:

1. The dropout voltage is defined as the difference between V_{IN} and V_{OUT} when V_{OUT} falls to 95% × V_{OUT(NOM)}.

TYPICAL PERFORMANCE CHARACTERISTICS

T_J = +25°C, C_{OUT} = 2.2µF and I_{OUT} = 0.1mA, unless otherwise noted.

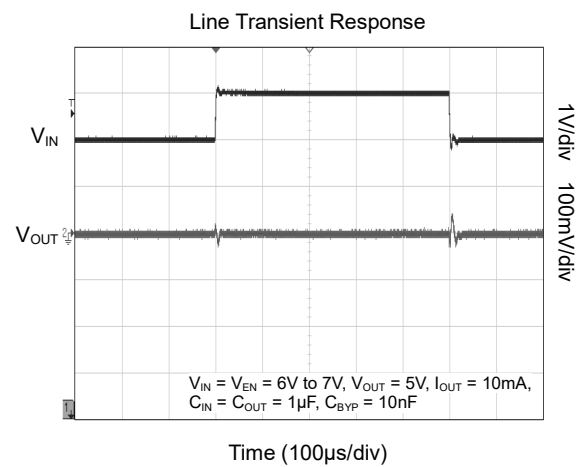
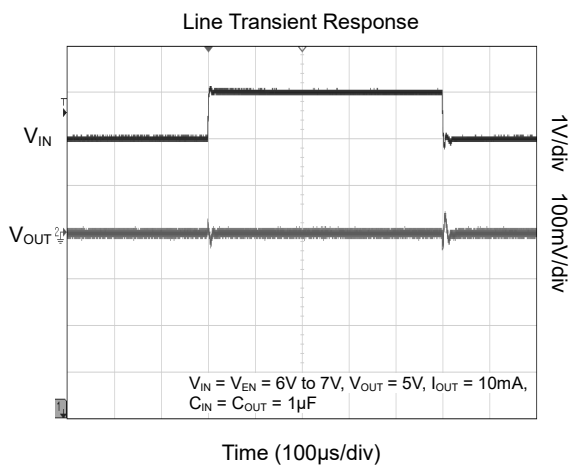
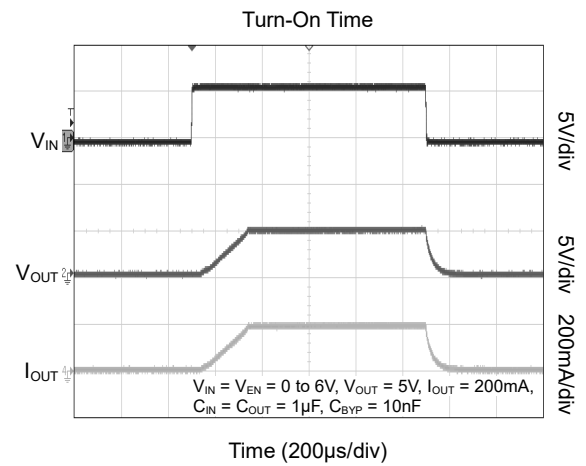
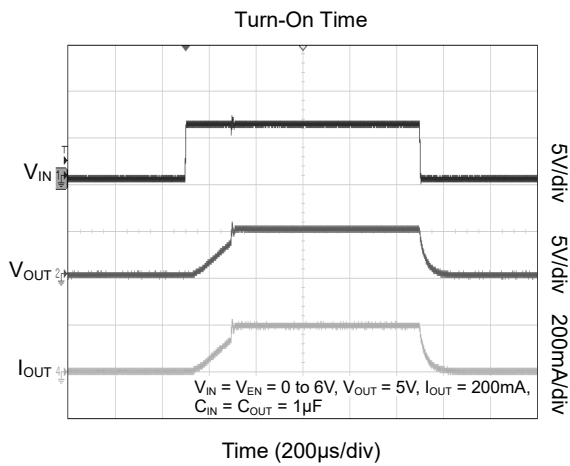
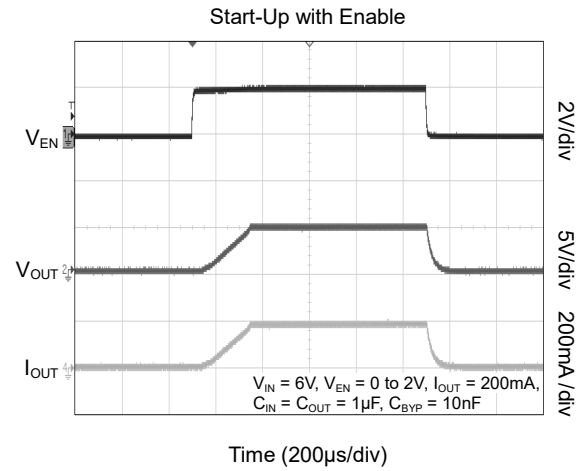
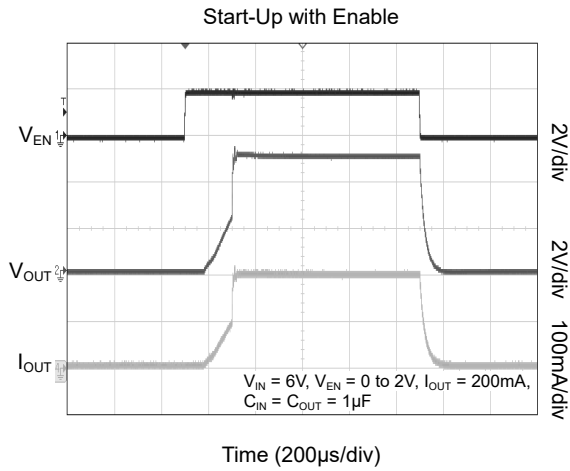

TYPICAL PERFORMANCE CHARACTERISTICS (continued)

T_J = +25°C, C_{OUT} = 2.2µF and I_{OUT} = 0.1mA, unless otherwise noted.

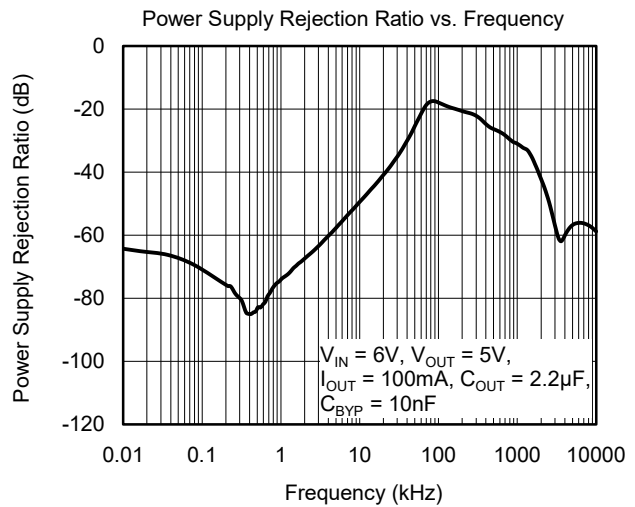
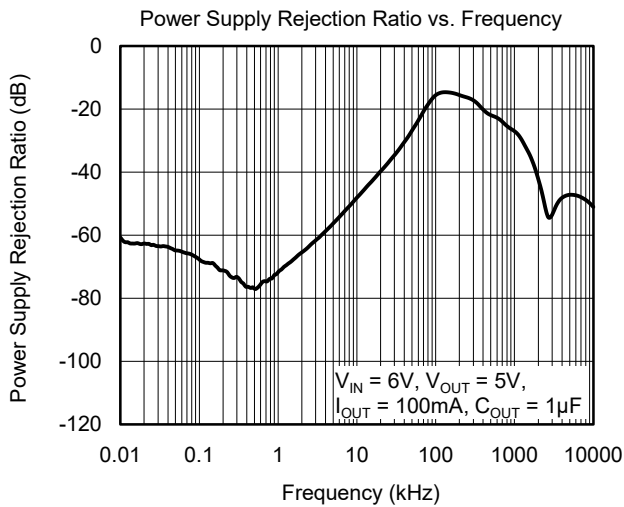
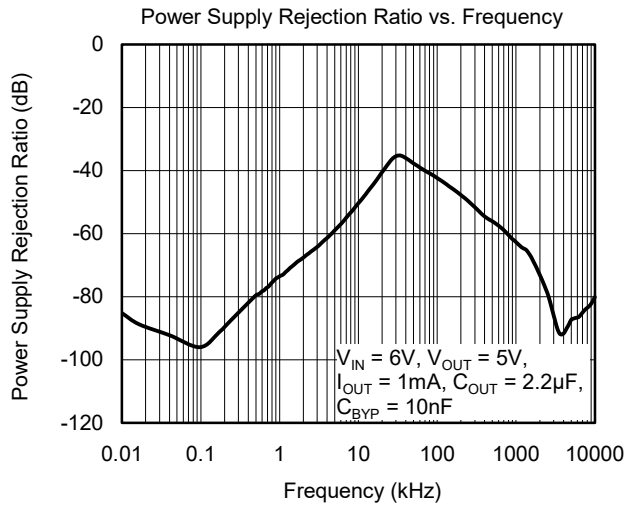
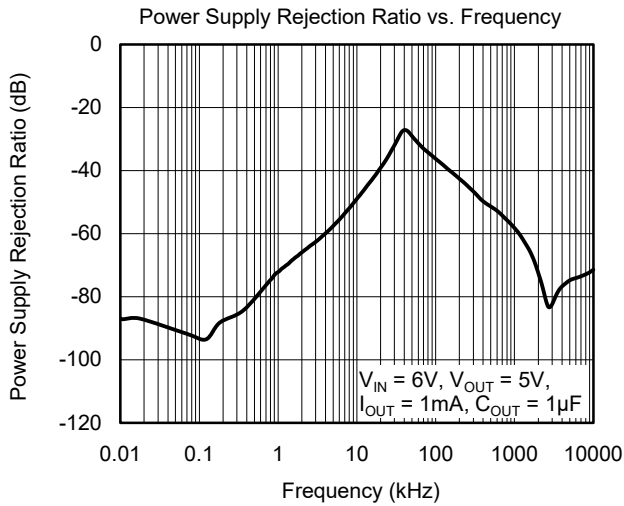
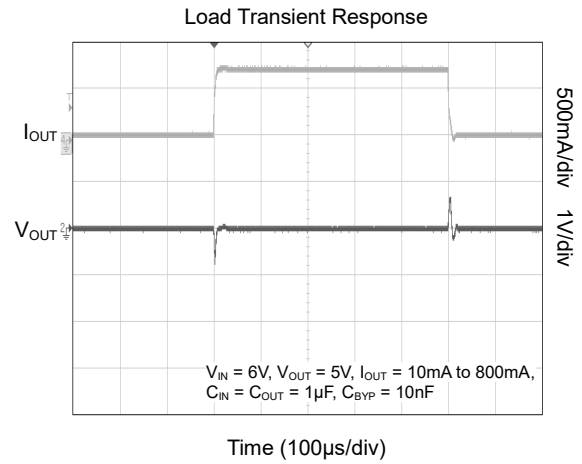
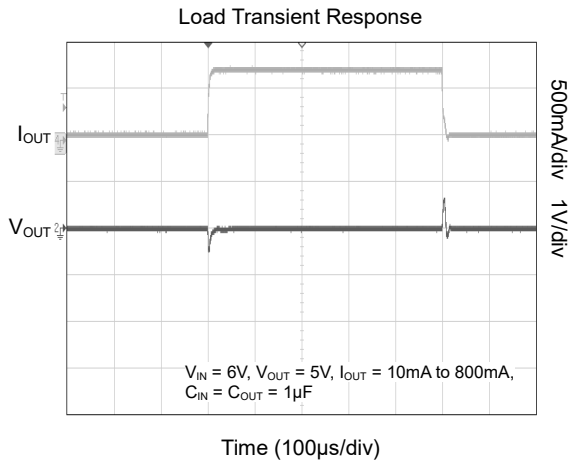

TYPICAL PERFORMANCE CHARACTERISTICS (continued)

T_J = +25°C, C_{OUT} = 2.2μF and I_{OUT} = 0.1mA, unless otherwise noted.

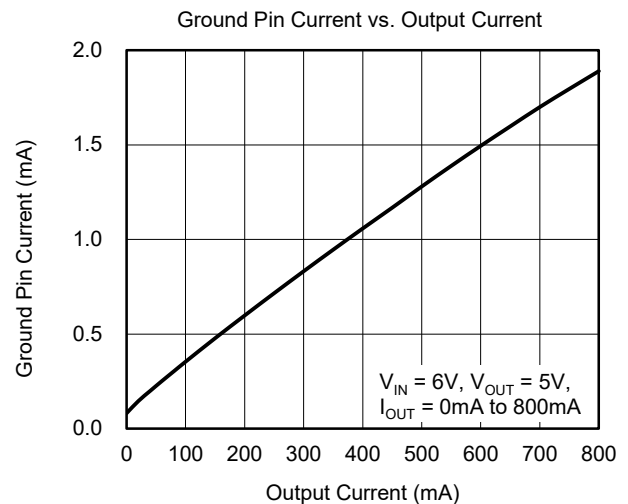
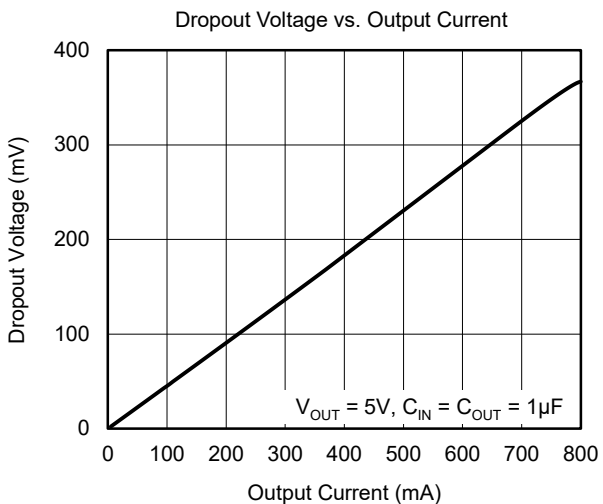
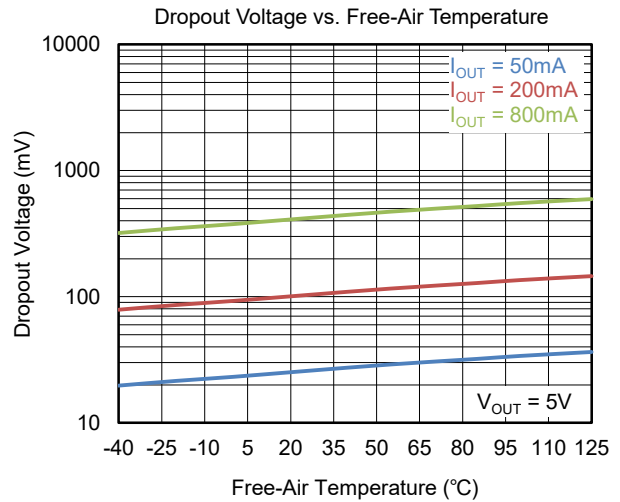
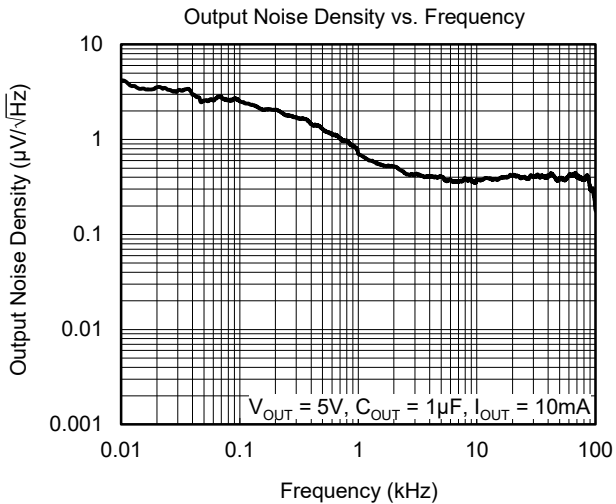
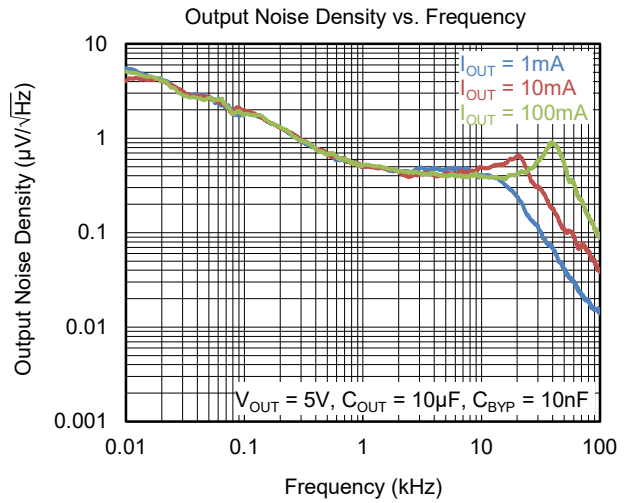
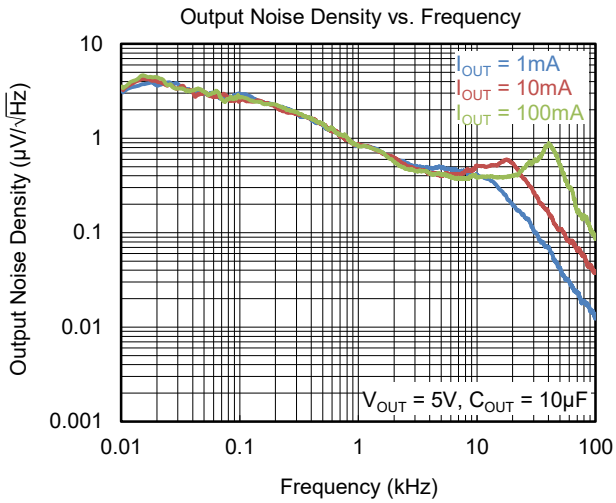

TYPICAL PERFORMANCE CHARACTERISTICS (continued)

T_J = +25°C, C_{OUT} = 2.2µF and I_{OUT} = 0.1mA, unless otherwise noted.

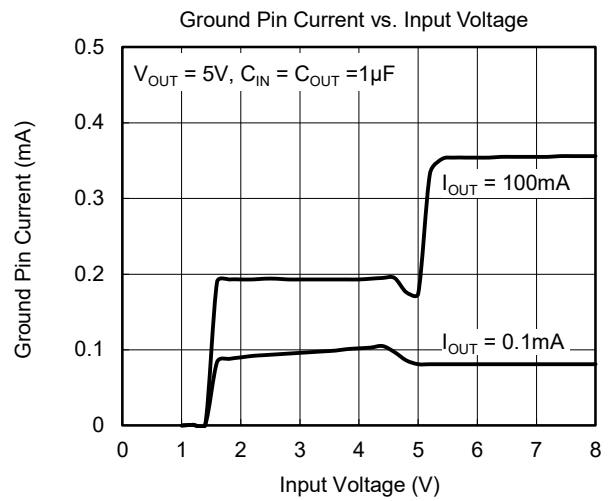
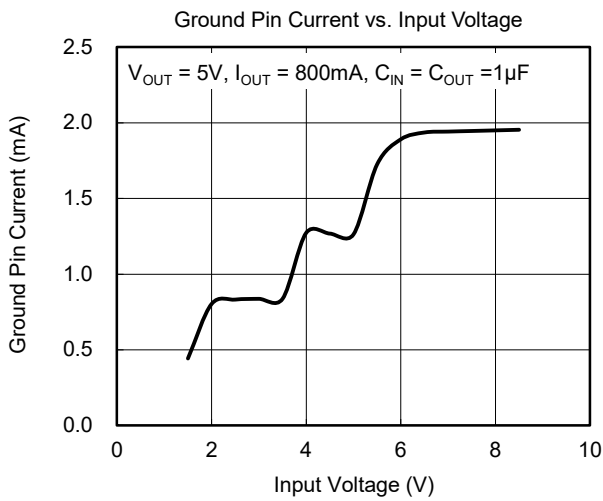
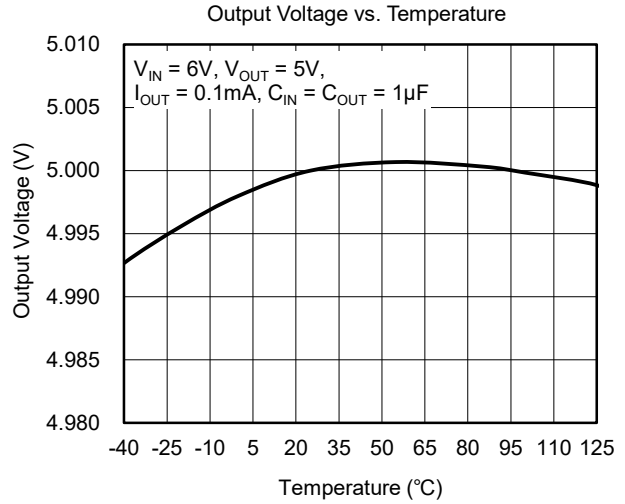
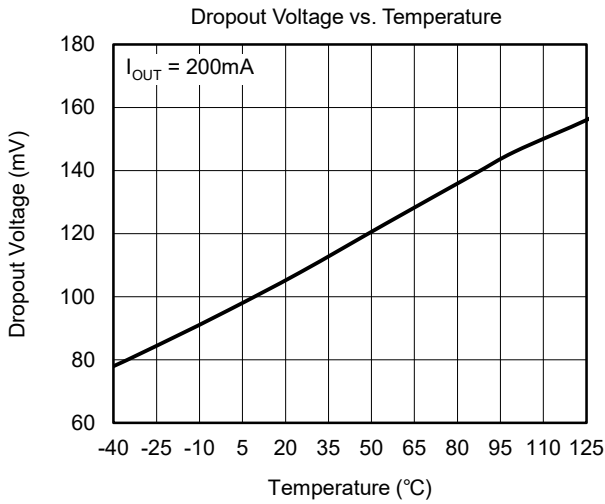

FUNCTIONAL BLOCK DIAGRAMS

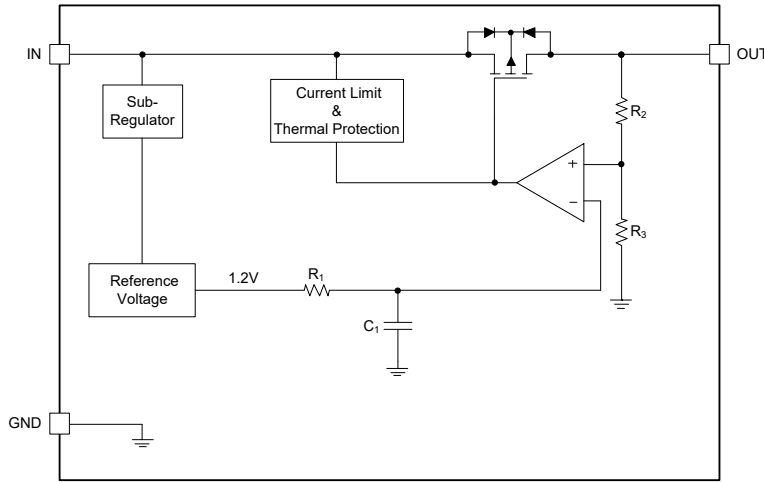

Figure 4. Internal Block Diagram of Fixed Output Voltage (SOT-89-3 and SOT-223-3 Versions)

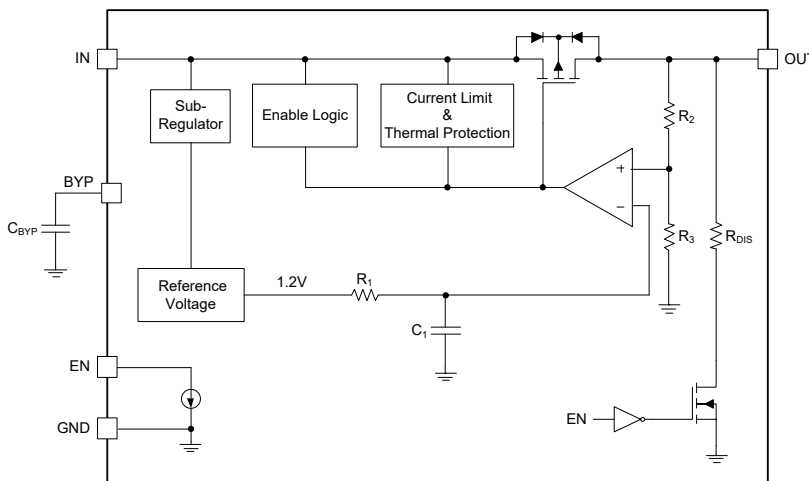

Figure 5. Internal Block Diagram of Low Noise Fixed Regulator (SOIC-8 and TO-263-5B Versions)

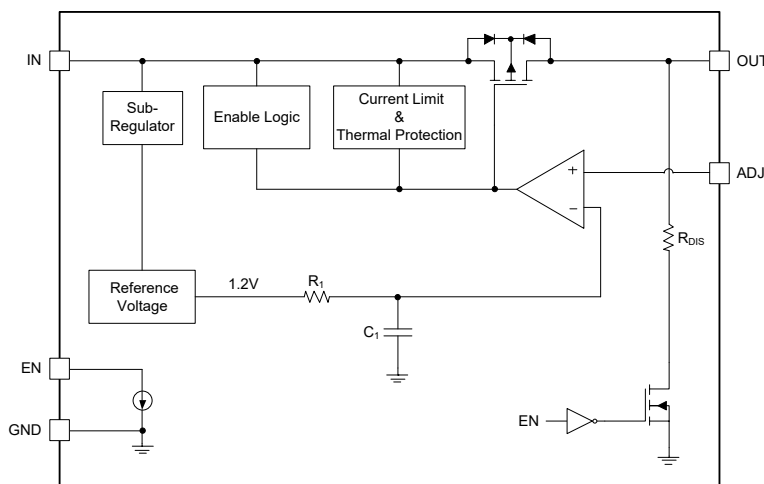

Figure 6. Internal Block Diagram of Adjustable Output Voltage (SOIC-8, TDFN-3x3-8L and TO-263-5B Versions)

APPLICATION INFORMATION

The SGM2205 is a high voltage, low noise and low dropout LDO and provides 800mA output current. These features make the device a reliable solution to solve many challenging problems in the generation of clean and accurate power supply. The high performance also makes the SGM2205 useful in a variety of applications. The SGM2205 provides protection functions for output overload, output short-circuit condition and overheating.

The SGM2205 provides an EN pin as an external chip enable control to enable/disable the device.

Input Capacitor Selection (C_{IN})

The input decoupling capacitor should be placed as close as possible to the IN pin to ensure the device stability. 1 μ F or larger X7R or X5R ceramic capacitor is selected to get good dynamic performance.

When V_{IN} is required to provide large current instantaneously, a large effective input capacitor is required. Multiple input capacitors can limit the input tracking inductance. Adding more input capacitors is available to restrict the ringing and to keep it below the device absolute maximum ratings.

Output Capacitor Selection (C_{OUT})

The output capacitor should be placed as close as possible to the OUT pin. 2.2 μ F or larger X7R or X5R ceramic capacitor is selected to get good dynamic performance. The minimum effective capacitance of C_{OUT} that SGM2205 can remain stable is 1 μ F. For ceramic capacitor, temperature, DC bias and package size will change the effective capacitance, so enough margin of C_{OUT} must be considered in design. Additionally, C_{OUT} with larger capacitance and lower ESR will help increase the high frequency PSRR and improve the load transient response.

Noise Bypass Capacitor (C_{BYP})

In noise sensitive applications, a bypass capacitor can be connected to the BYP pin (SOIC-8 and TO-263-5B packages only) to reduce the noise of output voltage. A 10nF ceramic capacitor is recommended in application.

Adjustable Regulator

The output voltage of the SGM2205-ADJ can be adjusted from 1.8V to 15V. The ADJ pin will be connected to two external resistors as shown in Figure 7, the output voltage is determined by the following equation:

$$V_{OUT} = V_{REF} \times \left(1 + \frac{R_1}{R_2} \right) \quad (1)$$

where:

V_{OUT} is output voltage and V_{FB} is the internal voltage reference, $V_{REF} = 1.2V$.

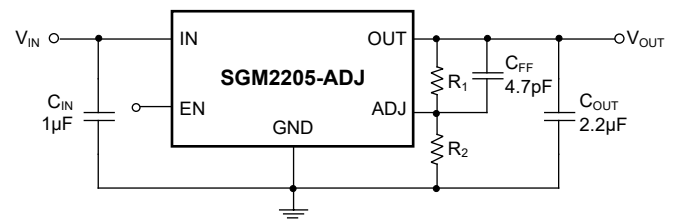

Figure 7. Adjustable Output Voltage Application

R_1 and R_2 can be calculated for any output voltage range using equation 1 and R_1 is recommended to be less than 470k Ω .

Enable Operation

The EN pin of the SGM2205 is used to enable/disable the device and to deactivate/activate the output automatic discharge function.

When the EN pin voltage is lower than 0.4V, the device is in shutdown state. There is no current flowing from IN to OUT pins. In this state, the automatic discharge transistor is active to discharge the output voltage through a resistor.

When the EN pin voltage is higher than 1.2V, the device is in active state. The output voltage is regulated to expected value and the automatic discharge transistor is turned off.

No-Load Stability

The SGM2205 can maintain stability without output load (except internal voltage divider).

APPLICATION INFORMATION (continued)

Input Power Supply

The input power supply range is from 2.5V to 20V. V_{IN} must be larger than $(V_{OUT} + V_{DROP})$ in application. The input ceramic capacitor must be placed as close as possible to the IN pin, this C_{IN} can help improve the output noise performance of LDO.

Output Current Limit and Short-Circuit Protection

When overload events happen, the output current is internally limited to 1100mA (TYP). When the OUT pin is shorted to ground, the short-circuit protection will limit the output current to 230mA (TYP).

Thermal Shutdown

The SGM2205 can detect the temperature of die. When the die temperature exceeds the threshold value of thermal shutdown, the SGM2205 will be in shutdown state and remain in this state until the die temperature decreases to +130°C.

Power Dissipation (P_D)

Thermal protection limits power dissipation in the SGM2205. When power dissipation on pass element ($P_D = (V_{IN} - V_{OUT}) \times I_{OUT}$) is too much and the operating junction temperature exceeds +155°C, the OTP circuit

starts the thermal shutdown function and turns the pass element off.

Therefore, thermal analysis for the chosen application is important to guarantee reliable performance over all conditions. To guarantee reliable operation, the junction temperature of the SGM2205 must not exceed +125°C.

The maximum allowable power dissipation depends on the thermal resistance of the IC package, the PCB layout, the rate of surrounding airflow, and the difference between the junction temperature and ambient temperature. The maximum power dissipation can be approximated using the following equation:

$$P_{D(MAX)} = (T_{J(MAX)} - T_A) / \theta_{JA} \quad (2)$$

where $T_{J(MAX)}$ is the maximum junction temperature, T_A is the ambient temperature, and θ_{JA} is the junction-to-ambient thermal resistance.

Layout Guidelines

To get good PSRR, low output noise and high transient response performance, the input and output bypass capacitors must be placed as close as possible to the IN pin and OUT pin separately. V_{IN} and V_{OUT} had better use separate ground planes and these ground planes are single point connected to the GND pin.

REVISION HISTORY

NOTE: Page numbers for previous revisions may differ from page numbers in the current version.

AUGUST 2022 – REV.A.1 to REV.A.2	Page
Updated Electrical Characteristics section	7
<hr/>	
NOVEMBER 2020 – REV.A to REV.A.1	Page
Added SGM2205-2.5XK3G/TR, SGM2205-3.3XK3G/TR, SGM2205-4.2XK3G/TR and SGM2205-5.0XK3G/TR versions.....	All
<hr/>	
Changes from Original (DECEMBER 2019) to REV.A	Page
Changed from product preview to production data.....	All

PACKAGE OUTLINE DIMENSIONS

SOT-89-3

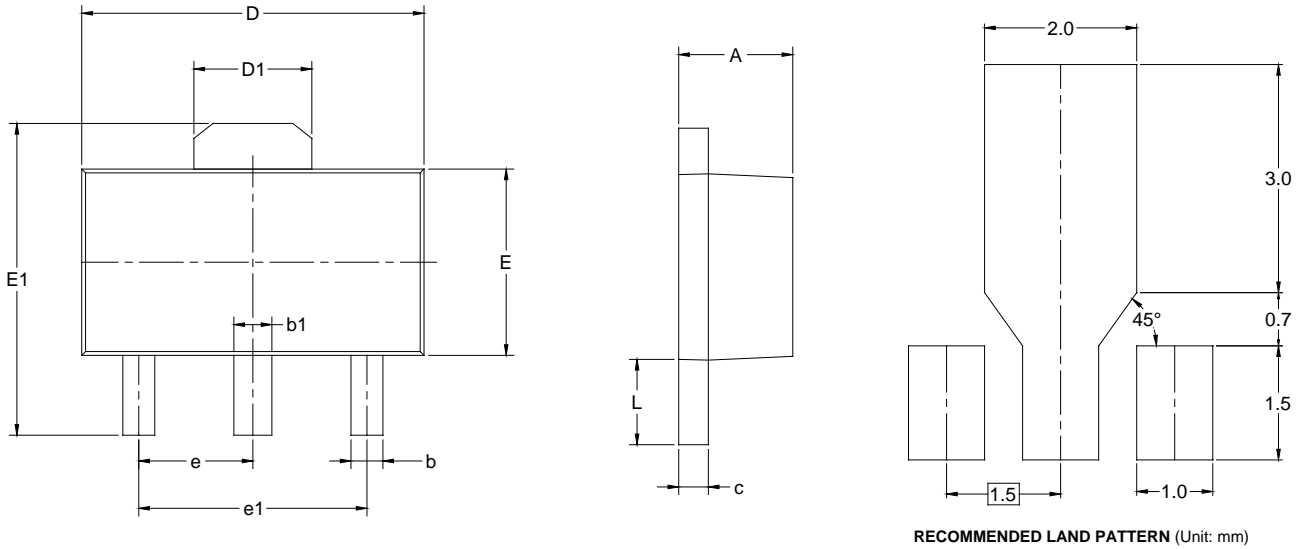

RECOMMENDED LAND PATTERN (Unit: mm)

Symbol	Dimensions In Millimeters		Dimensions In Inches	
	MIN	MAX	MIN	MAX
A	1.400	1.600	0.055	0.063
b	0.320	0.520	0.013	0.020
b1	0.400	0.580	0.016	0.023
c	0.350	0.440	0.014	0.017
D	4.400	4.600	0.173	0.181
D1	1.550 REF		0.061 REF	
E	2.300	2.600	0.091	0.102
E1	3.940	4.250	0.155	0.167
e	1.500 TYP		0.060 TYP	
e1	3.000 TYP		0.118 TYP	
L	0.900	1.200	0.035	0.047

- NOTES:
1. Body dimensions do not include mode flash or protrusion.
 2. This drawing is subject to change without notice.

PACKAGE OUTLINE DIMENSIONS

SOT-223-3

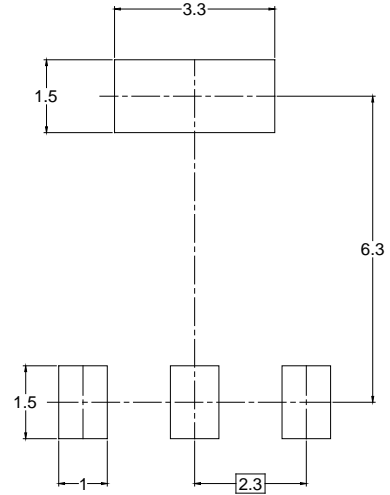
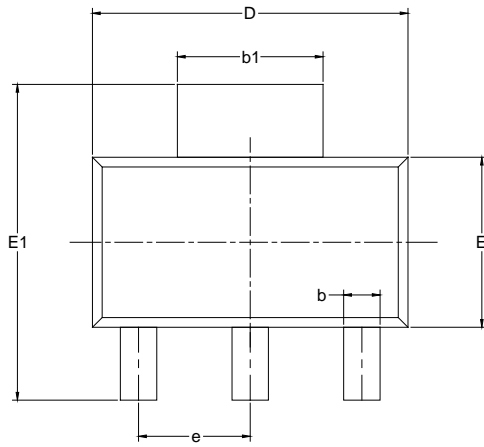

RECOMMENDED LAND PATTERN (Unit: mm)

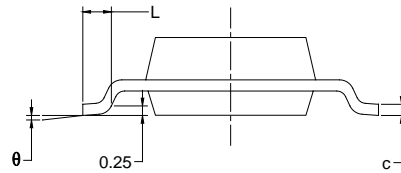
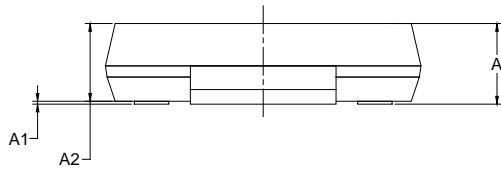

Symbol	Dimensions In Millimeters		Dimensions In Inches	
	MIN	MAX	MIN	MAX
A		1.800		0.071
A1	0.020	0.100	0.001	0.004
A2	1.500	1.700	0.059	0.067
b	0.660	0.840	0.026	0.033
b1	2.900	3.100	0.114	0.122
c	0.230	0.350	0.009	0.014
D	6.300	6.700	0.248	0.264
E	3.300	3.700	0.130	0.146
E1	6.700	7.300	0.264	0.287
e	2.300 BSC		0.091 BSC	
L	0.750		0.030	
θ	0°	10°	0°	10°

NOTES:

1. Body dimensions do not include mode flash or protrusion.
2. This drawing is subject to change without notice.

PACKAGE OUTLINE DIMENSIONS

SOIC-8

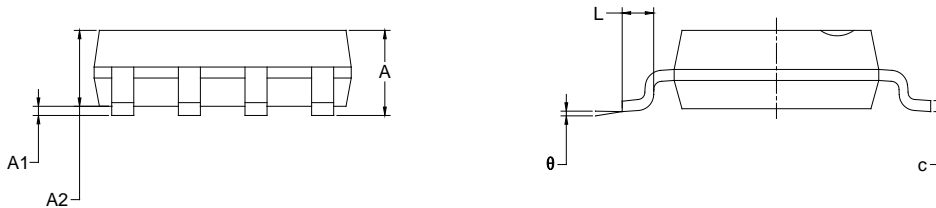
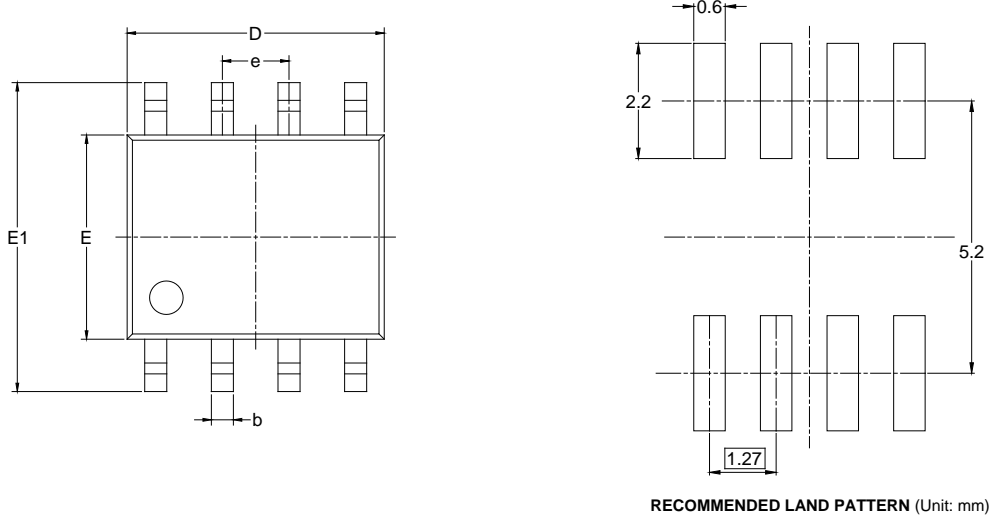

Symbol	Dimensions In Millimeters		Dimensions In Inches	
	MIN	MAX	MIN	MAX
A	1.350	1.750	0.053	0.069
A1	0.100	0.250	0.004	0.010
A2	1.350	1.550	0.053	0.061
b	0.330	0.510	0.013	0.020
c	0.170	0.250	0.006	0.010
D	4.700	5.100	0.185	0.200
E	3.800	4.000	0.150	0.157
E1	5.800	6.200	0.228	0.244
e	1.27 BSC		0.050 BSC	
L	0.400	1.270	0.016	0.050
θ	0°	8°	0°	8°

NOTES:
 1. Body dimensions do not include mode flash or protrusion.
 2. This drawing is subject to change without notice.

PACKAGE OUTLINE DIMENSIONS

TDFN-3x3-8L

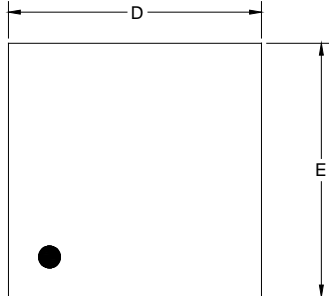

TOP VIEW

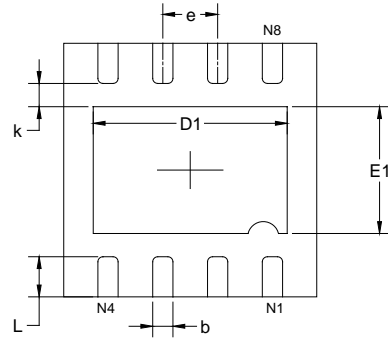

BOTTOM VIEW

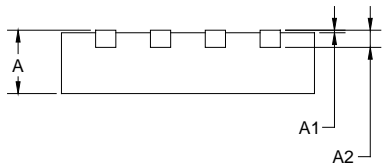

SIDE VIEW

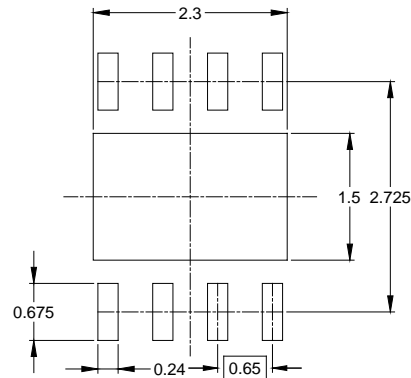

RECOMMENDED LAND PATTERN (Unit: mm)

Symbol	Dimensions In Millimeters		Dimensions In Inches	
	MIN	MAX	MIN	MAX
A	0.700	0.800	0.028	0.031
A1	0.000	0.050	0.000	0.002
A2	0.203 REF		0.008 REF	
D	2.900	3.100	0.114	0.122
D1	2.200	2.400	0.087	0.094
E	2.900	3.100	0.114	0.122
E1	1.400	1.600	0.055	0.063
k	0.200 MIN		0.008 MIN	
b	0.180	0.300	0.007	0.012
e	0.650 TYP		0.026 TYP	
L	0.375	0.575	0.015	0.023

NOTE: This drawing is subject to change without notice.

PACKAGE OUTLINE DIMENSIONS

TO-263-5B

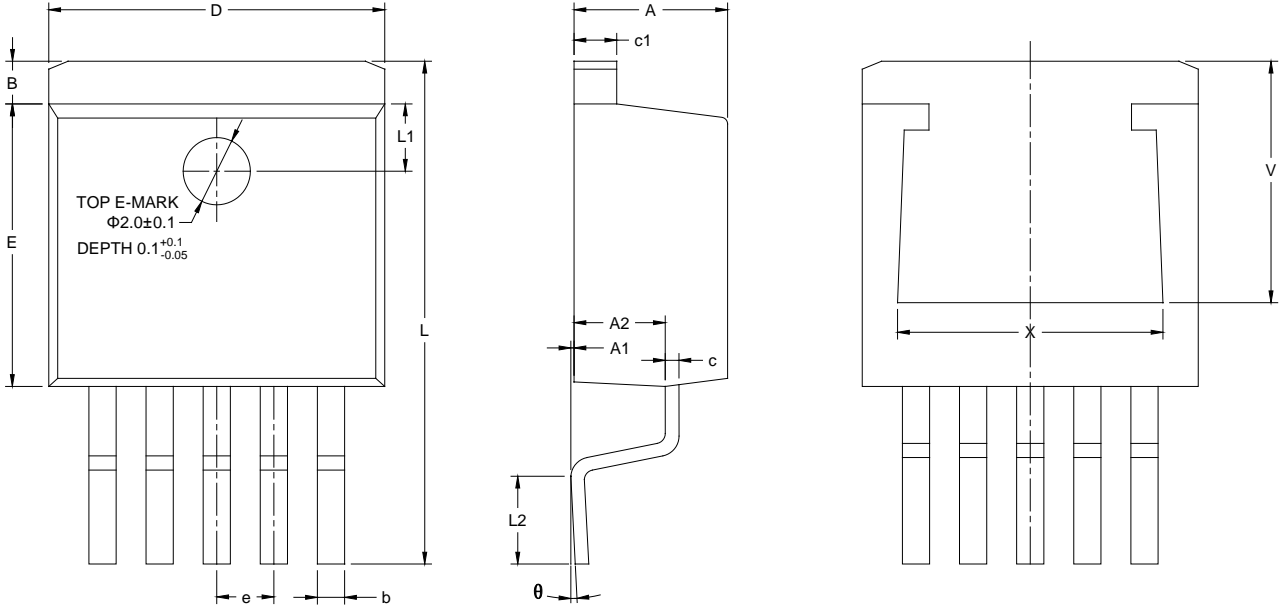

Symbol	Dimensions In Millimeters		
	MIN	MOD	MAX
A	4.40	4.57	4.70
A1	0	0.10	0.25
A2	2.59	2.69	2.79
b	0.77	-	0.90
c	0.34	-	0.47
c1	1.22	-	1.32
e	1.70 BSC		
D	10.06	10.16	10.26
E	9.05	9.15	9.25
B	1.17	1.27	1.40
V	6.86	-	7.50
X	7.50	-	8.30
L	14.70	15.10	15.50
L1	2.00 REF		
L2	2.00	2.30	2.60
theta	0°	-	8°

NOTES:
 1. Body dimensions do not include mode flash or protrusion.
 2. This drawing is subject to change without notice.

PACKAGE INFORMATION

TAPE AND REEL INFORMATION

REEL DIMENSIONS

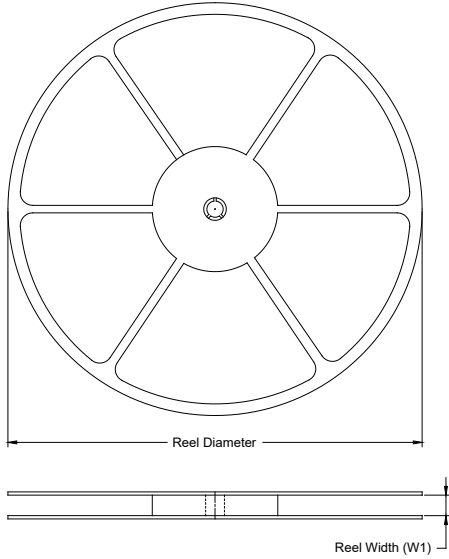

TAPE DIMENSIONS

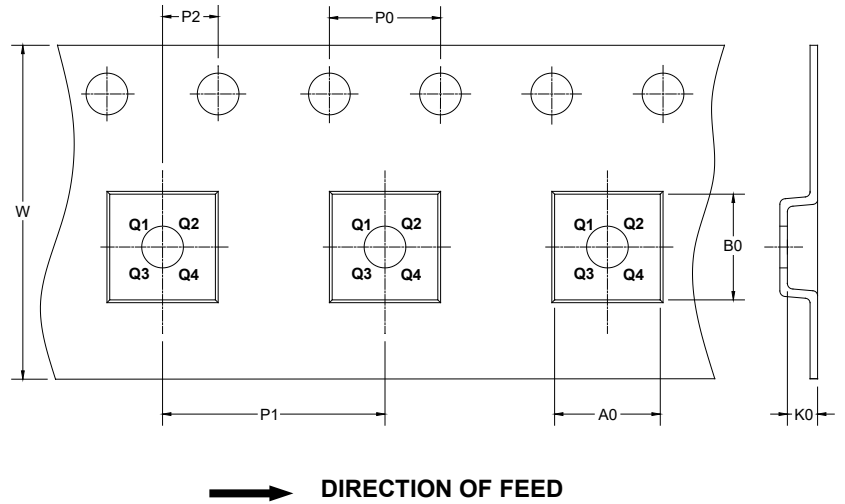

NOTE: The picture is only for reference. Please make the object as the standard.

KEY PARAMETER LIST OF TAPE AND REEL

Package Type	Reel Diameter	Reel Width W1 (mm)	A0 (mm)	B0 (mm)	K0 (mm)	P0 (mm)	P1 (mm)	P2 (mm)	W (mm)	Pin1 Quadrant
SOT-89-3	7"	13.2	4.85	4.45	1.85	4.0	8.0	2.0	12.0	Q3
SOT-223-3	13"	12.4	6.55	7.25	1.90	4.0	8.0	2.0	12.0	Q3
SOIC-8	13"	12.4	6.40	5.40	2.10	4.0	8.0	2.0	12.0	Q1
TDFN-3×3-8L	13"	12.4	3.35	3.35	1.13	4.0	8.0	2.0	12.0	Q1
TO-263-5B	13"	24.4	10.80	16.30	5.11	4.0	16.0	2.0	24.0	

PACKAGE INFORMATION

CARTON BOX DIMENSIONS



NOTE: The picture is only for reference. Please make the object as the standard.

KEY PARAMETER LIST OF CARTON BOX

Reel Type	Length (mm)	Width (mm)	Height (mm)	Pizza/Carton
7" (Option)	368	227	224	8
7"	442	410	224	18
13"	386	280	370	5

DD0002

单击下面可查看定价，库存，交付和生命周期等信息

[>>SGMICRO\(圣邦微电子\)](#)