



SGM8951/SGM8952 110kHz, Rail-to-Rail Input and Output Operational Amplifiers

GENERAL DESCRIPTION

The single SGM8951 and dual SGM8952 are high performance CMOS operational amplifiers optimized for low voltage operation. These devices operate from 1.8V to 5.5V single supply, consuming low quiescent current. They provide rail-to-rail input and output operation.

The SGM8951/2 offer impressive overall performance. They feature low offset, excellent CMRR and high linearity. These devices work well in low voltage and high quality systems, such as sensor amplification and sensor conditioning.

The SGM8951 is available in Green SOT-23-5 and SOIC-8 packages. The SGM8952 is available in Green SOIC-8 and MSOP-8 packages. They are specified over the extended -40°C to +85°C temperature range.

FEATURES

- **Low Input Offset Voltage:** 0.2mV (TYP)
- **Gain-Bandwidth Product:** 110kHz
- **Rail-to-Rail Input and Output**
- **Supply Voltage Range:** 1.8V to 5.5V
- **Low Supply Current:**
 - SGM8951 26 μ A (TYP)
 - SGM8952 34 μ A (TYP)
- **-40°C to +85°C Operating Temperature Range**
- **Small Packaging:**
 - SGM8951 Available in SOT-23-5 and SOIC-8 Packages
 - SGM8952 Available in MSOP-8 and SOIC-8 Packages

APPLICATIONS

Data Acquisition
Process Control
Active Filter
Test Equipment
Mobile Phone
Audio Processing
Video Processing
Headphone Amplifier
Portable Equipment
Broadband Communication

PACKAGE/ORDERING INFORMATION

MODEL	PACKAGE DESCRIPTION	SPECIFIED TEMPERATURE RANGE	ORDERING NUMBER	PACKAGE MARKING	PACKING OPTION
SGM8951	SOT-23-5	-40°C to +85°C	SGM8951YN5G/TR	SBEXX	Tape and Reel, 3000
	SOIC-8	-40°C to +85°C	SGM8951YS8G/TR	SGM 8951YS8 XXXXX	Tape and Reel, 2500
SGM8952	SOIC-8	-40°C to +85°C	SGM8952YS8G/TR	SGM 8952YS8 XXXXX	Tape and Reel, 2500
	MSOP-8	-40°C to +85°C	SGM8952YMS8G/TR	SGM8952 YMS8 XXXXX	Tape and Reel, 3000

MARKING INFORMATION

NOTE: XX = Date Code. XXXXX = Date Code and Vendor Code.

SOT-23-5

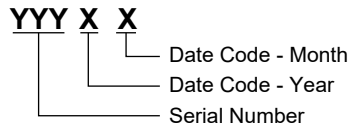

SOIC-8/MSOP-8

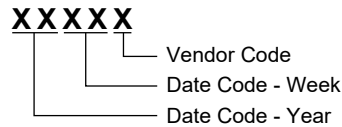

Green (RoHS & HSF): SG Micro Corp defines "Green" to mean Pb-Free (RoHS compatible) and free of halogen substances. If you have additional comments or questions, please contact your SGMICRO representative directly.

ABSOLUTE MAXIMUM RATINGS

- Supply Voltage, +Vs to -Vs.....6V
- Voltage at Input/Output Pins
..... (-Vs) - 0.3V to (+Vs) + 0.3V
- Input Common Mode Voltage Range
..... (-Vs) - 0.1V to (+Vs) + 0.1V
- Junction Temperature+150°C
- Storage Temperature Range.....-65°C to +150°C
- Lead Temperature (Soldering, 10s)+260°C
- ESD Susceptibility
- HBM.....8000V
- MM.....400V

RECOMMENDED OPERATING CONDITIONS

- Operating Temperature Range-40°C to +85°C

OVERSTRESS CAUTION

Stresses beyond those listed in Absolute Maximum Ratings may cause permanent damage to the device. Exposure to absolute maximum rating conditions for extended periods

may affect reliability. Functional operation of the device at any conditions beyond those indicated in the Recommended Operating Conditions section is not implied.

ESD SENSITIVITY CAUTION

This integrated circuit can be damaged if ESD protections are not considered carefully. SGMICRO recommends that all integrated circuits be handled with appropriate precautions. Failure to observe proper handling and installation procedures can cause damage. ESD damage can range from subtle performance degradation to complete device failure. Precision integrated circuits may be more susceptible to damage because even small parametric changes could cause the device not to meet the published specifications.

DISCLAIMER

SG Micro Corp reserves the right to make any change in circuit design, or specifications without prior notice.

PIN CONFIGURATIONS

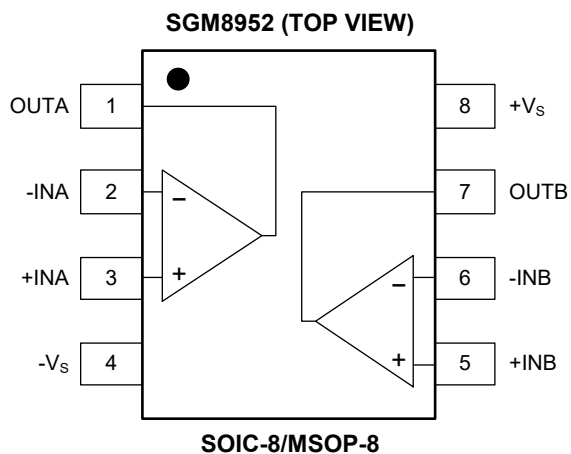
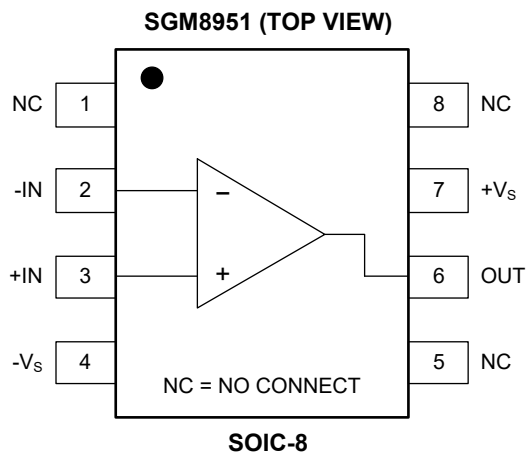
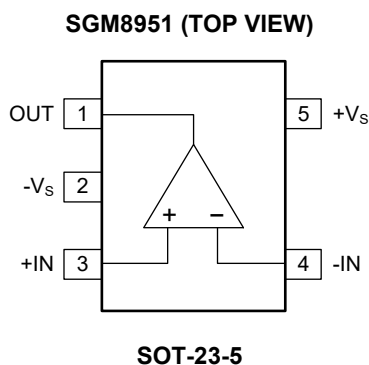

ELECTRICAL CHARACTERISTICS

(At $T_A = +25^\circ\text{C}$, $V_S = 5\text{V}$, $R_L = 100\text{k}\Omega$ connected to $V_S/2$ and $V_{OUT} = V_S/2$, Full = -40°C to $+85^\circ\text{C}$, unless otherwise noted.)

PARAMETER	CONDITIONS	TEMP	MIN	TYP	MAX	UNITS	
DC Performance							
Input Offset Voltage (V_{OS})	$V_{CM} = V_S/2$	+25°C		0.2	0.8	mV	
		Full			1.2		
Open-Loop Voltage Gain (A_{OL})	$R_L = 10\text{k}\Omega$, $V_{OUT} = 0.15\text{V}$ to 4.85V	+25°C	78	90		dB	
		Full	73				
	$R_L = 100\text{k}\Omega$, $V_{OUT} = 0.05\text{V}$ to 4.95V	+25°C		92			
Input Characteristics							
Input Common Mode Voltage Range (V_{CM})		+25°C	-0.1		5.1	V	
Common Mode Rejection Ratio (CMRR)	$V_{CM} = -0.1\text{V}$ to 5.1V	+25°C	77	92		dB	
		Full	73				
Output Characteristics							
Output Voltage Swing from Rail	$R_L = 2\text{k}\Omega$, $V_{CM} = V_S/2$	+25°C		78	94	mV	
		Full			103		
	$R_L = 10\text{k}\Omega$, $V_{CM} = V_S/2$	+25°C		16	28		
		Full			33		
Output Short-Circuit Current (I_{SC})	$R_L = 10\Omega$ to $V_S/2$	+25°C	25	32		mA	
		Full	17				
Power Supply							
Operating Voltage Range			1.8		5.5	V	
Quiescent Current	SGM8951	$I_{OUT} = 0\text{mA}$, $V_{CM} = V_S/2$	+25°C		26	35	μA
			Full			39	
	SGM8952	$I_{OUT} = 0\text{mA}$, $V_{CM} = V_S/2$	+25°C		34	48	
			Full			55	
Dynamic Performance ⁽¹⁾							
Gain-Bandwidth Product (GBP)	$C_L = 100\text{pF}$, $R_L = 100\text{k}\Omega$	+25°C		110		kHz	
Slew Rate	$V_{OUT} = 2V_{P-P}$, $A_V = 1$	+25°C		45		V/ms	
Noise/Distortion Performance							
Input Voltage Noise Density (e_n)	$f = 1\text{kHz}$	+25°C		115		$\text{nV}/\sqrt{\text{Hz}}$	
Input Voltage Noise	$f = 0.1\text{Hz}$ to 10Hz	+25°C		3.5		μV_{P-P}	

NOTE: 1. Power supply bypassing is an effective method to clear up the noise at power supply, and the low impedance path to ground of decoupling capacitor will bypass the noise to GND. A $10\mu\text{F}$ ceramic capacitor paralleled with a $0.1\mu\text{F}$ ceramic capacitor is used. The ceramic capacitors should be placed as close as possible to $+V_S$ pin. A large ground plane is also needed to ensure optimum performance.

ELECTRICAL CHARACTERISTICS (continued)

(At $T_A = +25^\circ\text{C}$, $V_S = 1.8\text{V}$, $R_L = 100\text{k}\Omega$ connected to $V_S/2$ and $V_{OUT} = V_S/2$, Full = -40°C to $+85^\circ\text{C}$, unless otherwise noted.)

PARAMETER	CONDITIONS	TEMP	MIN	TYP	MAX	UNITS	
DC Performance							
Input Offset Voltage (V_{OS})	$V_{CM} = V_S/2$	+25°C		0.3	0.9	mV	
		Full			1.25		
Open-Loop Voltage Gain (A_{OL})	$R_L = 10\text{k}\Omega$, $V_{OUT} = 0.15\text{V}$ to 1.65V	+25°C	83	100		dB	
		Full	80				
	$R_L = 100\text{k}\Omega$, $V_{OUT} = 0.05\text{V}$ to 1.75V	+25°C		107		dB	
Input Characteristics							
Input Common Mode Voltage Range (V_{CM})		+25°C	-0.1		1.9	V	
Common Mode Rejection Ratio (CMRR)	$V_{CM} = -0.1\text{V}$ to 1.9V	+25°C	73	89		dB	
		Full	70				
Output Characteristics							
Output Voltage Swing from Rail	$R_L = 2\text{k}\Omega$, $V_{CM} = V_S/2$	+25°C		49	69	mV	
		Full			76		
	$R_L = 10\text{k}\Omega$, $V_{CM} = V_S/2$	+25°C		11	23		
		Full			28		
Output Short-Circuit Current (I_{SC})	$R_L = 10\Omega$ to $V_S/2$	+25°C	0.9	4		mA	
		Full	0.5				
Power Supply							
Quiescent Current	SGM8951	$V_{CM} = V_S/2$, $I_{OUT} = 0\text{mA}$	+25°C		22	30	μA
			Full			34	
	SGM8952	$V_{CM} = V_S/2$, $I_{OUT} = 0\text{mA}$	+25°C		30	43	
			Full			49	
Power Supply Rejection Ratio (PSRR)	$V_S = 1.8\text{V}$ to 5.5V , $V_{CM} = 0.5\text{V}$	+25°C	74	80		dB	
		Full	70				
Dynamic Performance ⁽¹⁾							
Gain-Bandwidth Product (GBP)	$C_L = 100\text{pF}$, $R_L = 100\text{k}\Omega$	+25°C		100		kHz	
Slew Rate	$V_{OUT} = 1V_{P-P}$, $A_V = 1$	+25°C		40		V/ms	
Noise/Distortion Performance							
Input Voltage Noise Density (e_n)	$f = 1\text{kHz}$	+25°C		115		$\text{nV}/\sqrt{\text{Hz}}$	
Input Voltage Noise	$f = 0.1\text{Hz}$ to 10Hz	+25°C		3.5		μV_{P-P}	

NOTE: 1. Power supply bypassing is an effective method to clear up the noise at power supply, and the low impedance path to ground of decoupling capacitor will bypass the noise to GND. A $10\mu\text{F}$ ceramic capacitor paralleled with a $0.1\mu\text{F}$ ceramic capacitor is used. The ceramic capacitors should be placed as close as possible to $+V_S$ pin. A large ground plane is also needed to ensure optimum performance.

TYPICAL PERFORMANCE CHARACTERISTICS

At $T_A = +25^\circ\text{C}$, $V_S = 5\text{V}$, unless otherwise noted.

Small Signal Step Response

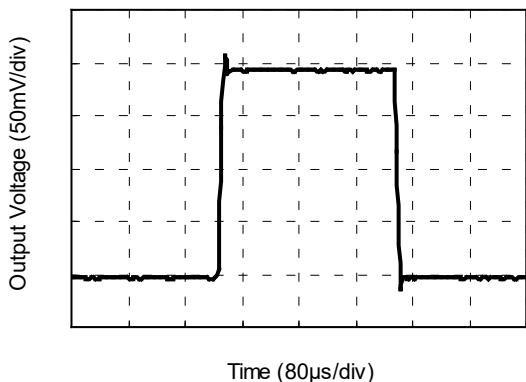

Large Signal Step Response

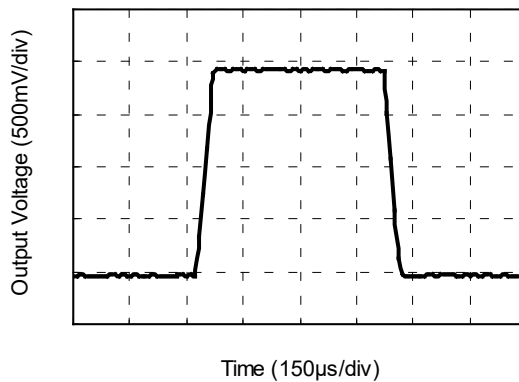

CMRR and PSRR vs. Frequency

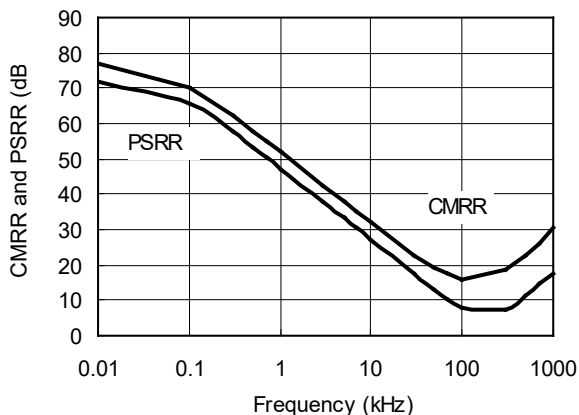

Voltage Noise Spectral Density vs. Frequency

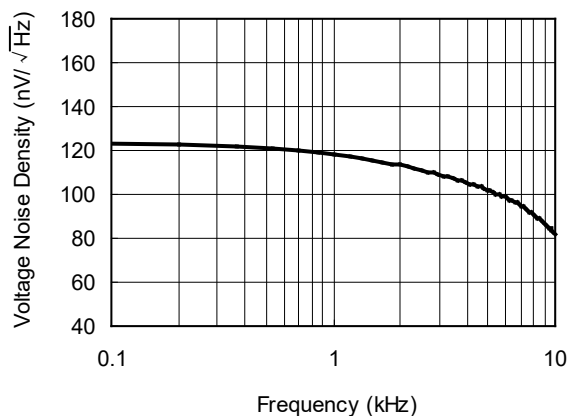

Quiescent Current vs. Temperature

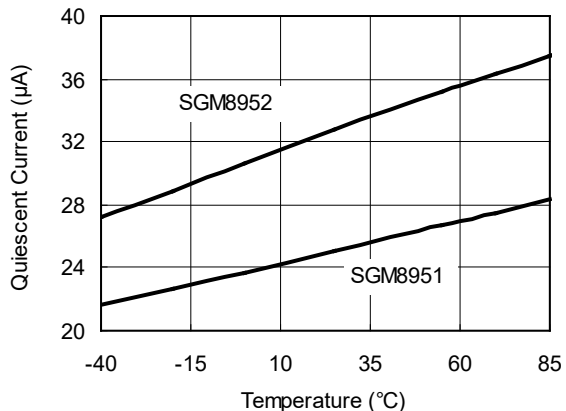

Open-Loop Voltage Gain vs. Temperature

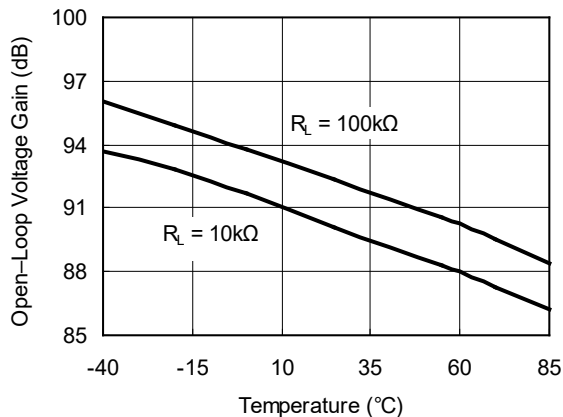

TYPICAL PERFORMANCE CHARACTERISTICS (continued)

At $T_A = +25^\circ\text{C}$, $V_S = 5\text{V}$, unless otherwise noted.

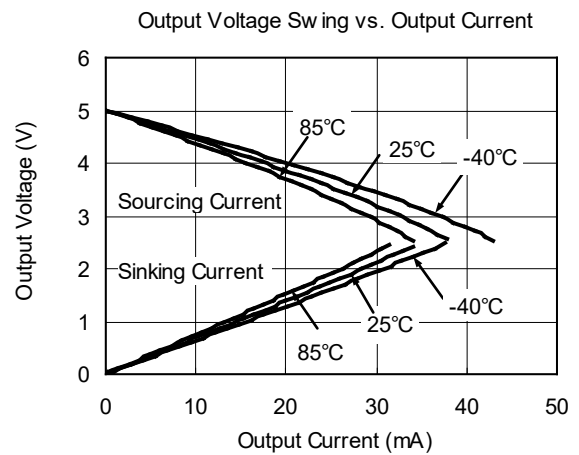
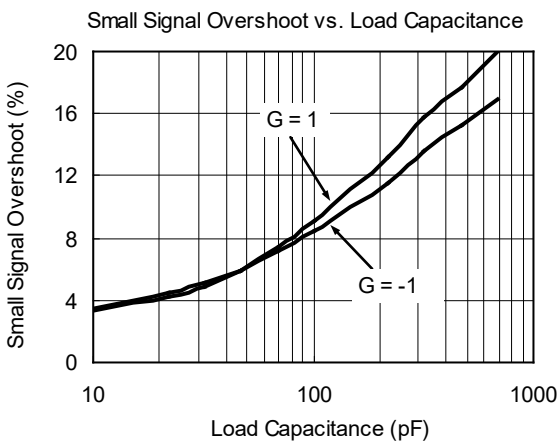
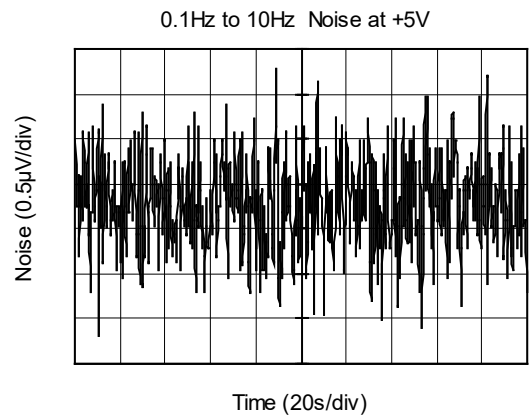
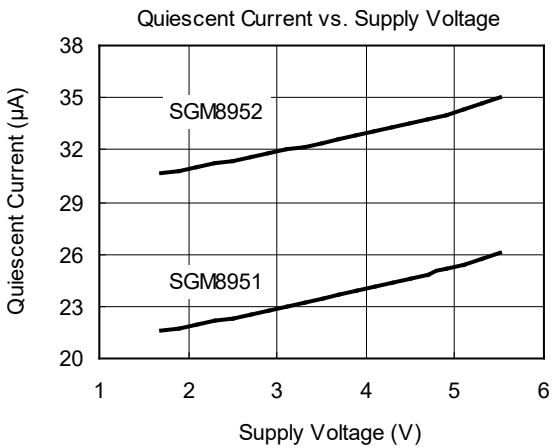
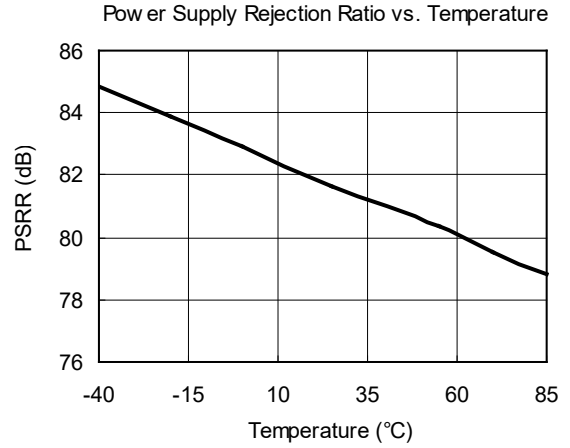
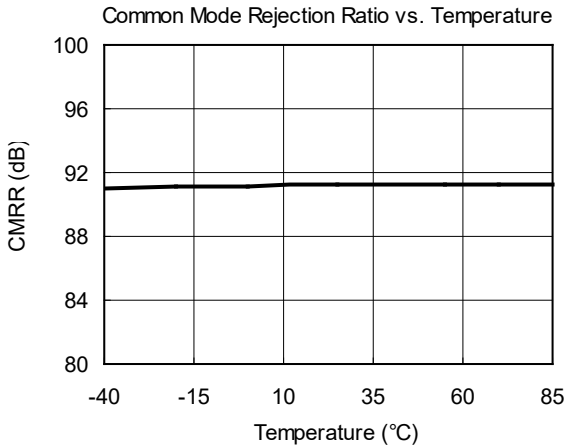

TYPICAL PERFORMANCE CHARACTERISTICS (continued)

At $T_A = +25^\circ\text{C}$, $V_S = 5\text{V}$, unless otherwise noted.

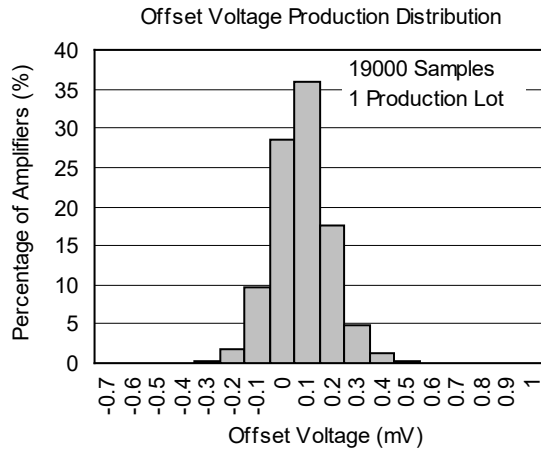

REVISION HISTORY

NOTE: Page numbers for previous revisions may differ from page numbers in the current version.

MAY 2013 – REV.A to REV.A.1	Page
Changed Electrical Characteristics section	4, 5

Changes from Original (DECEMBER 2012) to REV.A	Page
Changed from product preview to production data.....	All

PACKAGE OUTLINE DIMENSIONS

SOT-23-5

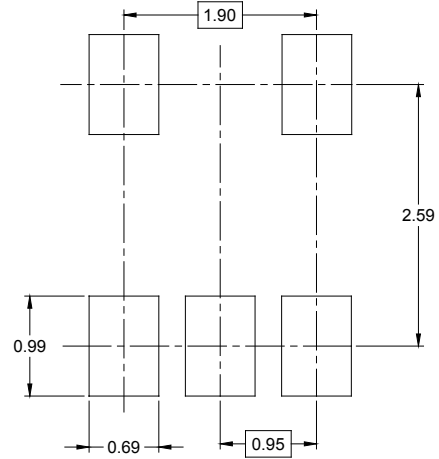

RECOMMENDED LAND PATTERN (Unit: mm)



Symbol	Dimensions In Millimeters		Dimensions In Inches	
	MIN	MAX	MIN	MAX
A	1.050	1.250	0.041	0.049
A1	0.000	0.100	0.000	0.004
A2	1.050	1.150	0.041	0.045
b	0.300	0.500	0.012	0.020
c	0.100	0.200	0.004	0.008
D	2.820	3.020	0.111	0.119
E	1.500	1.700	0.059	0.067
E1	2.650	2.950	0.104	0.116
e	0.950 BSC		0.037 BSC	
e1	1.900 BSC		0.075 BSC	
L	0.300	0.600	0.012	0.024
θ	0°	8°	0°	8°

PACKAGE OUTLINE DIMENSIONS

SOIC-8

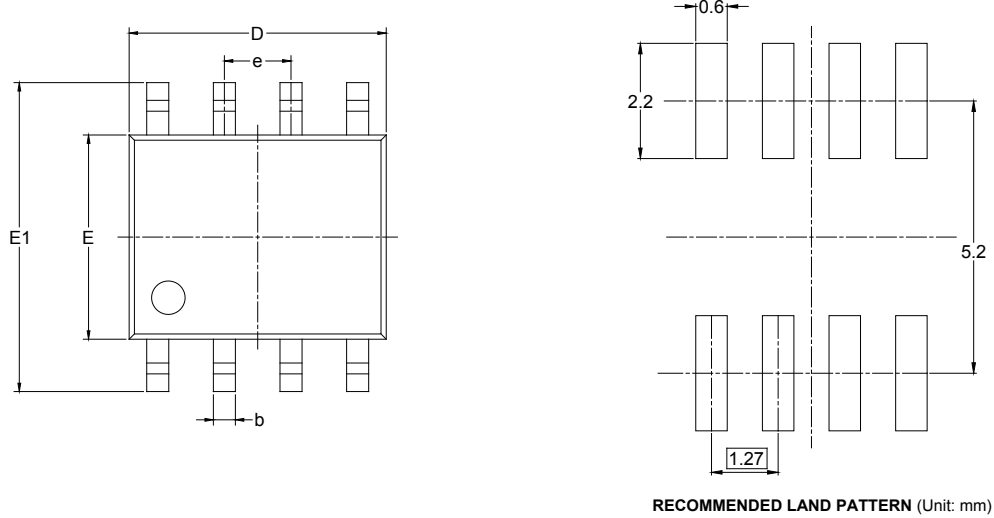

Symbol	Dimensions In Millimeters		Dimensions In Inches	
	MIN	MAX	MIN	MAX
A	1.350	1.750	0.053	0.069
A1	0.100	0.250	0.004	0.010
A2	1.350	1.550	0.053	0.061
b	0.330	0.510	0.013	0.020
c	0.170	0.250	0.006	0.010
D	4.700	5.100	0.185	0.200
E	3.800	4.000	0.150	0.157
E1	5.800	6.200	0.228	0.244
e	1.27 BSC		0.050 BSC	
L	0.400	1.270	0.016	0.050
θ	0°	8°	0°	8°

PACKAGE OUTLINE DIMENSIONS

MSOP-8

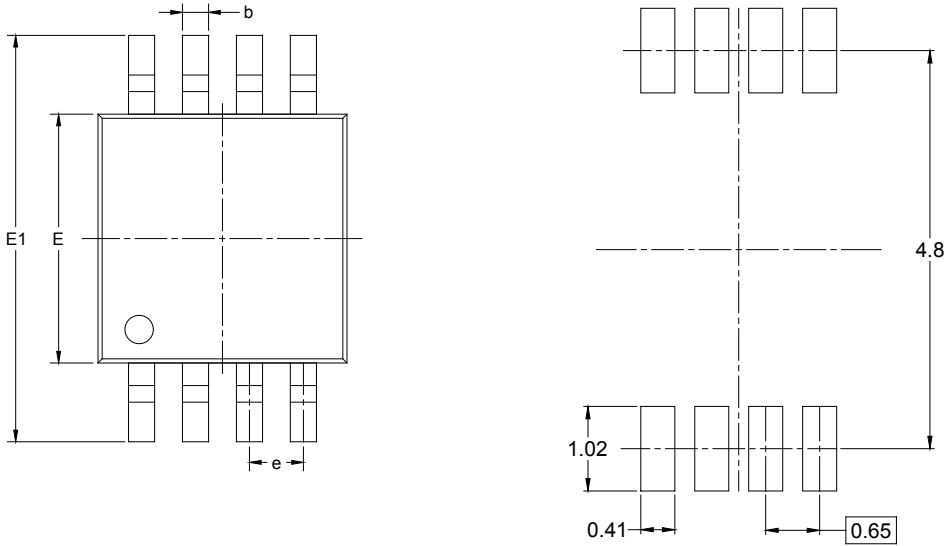

RECOMMENDED LAND PATTERN (Unit: mm)

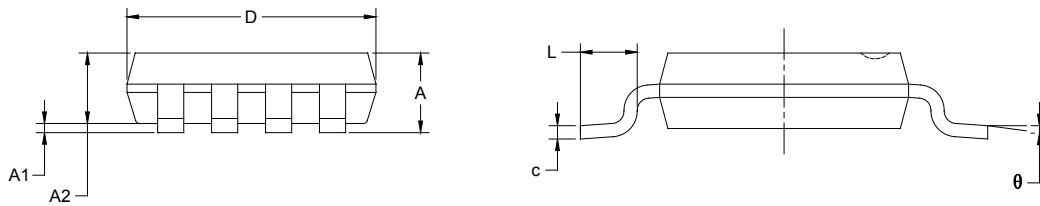

Symbol	Dimensions In Millimeters		Dimensions In Inches	
	MIN	MAX	MIN	MAX
A	0.820	1.100	0.032	0.043
A1	0.020	0.150	0.001	0.006
A2	0.750	0.950	0.030	0.037
b	0.250	0.380	0.010	0.015
c	0.090	0.230	0.004	0.009
D	2.900	3.100	0.114	0.122
E	2.900	3.100	0.114	0.122
E1	4.750	5.050	0.187	0.199
e	0.650 BSC		0.026 BSC	
L	0.400	0.800	0.016	0.031
θ	0°	6°	0°	6°

PACKAGE INFORMATION

TAPE AND REEL INFORMATION

REEL DIMENSIONS



TAPE DIMENSIONS

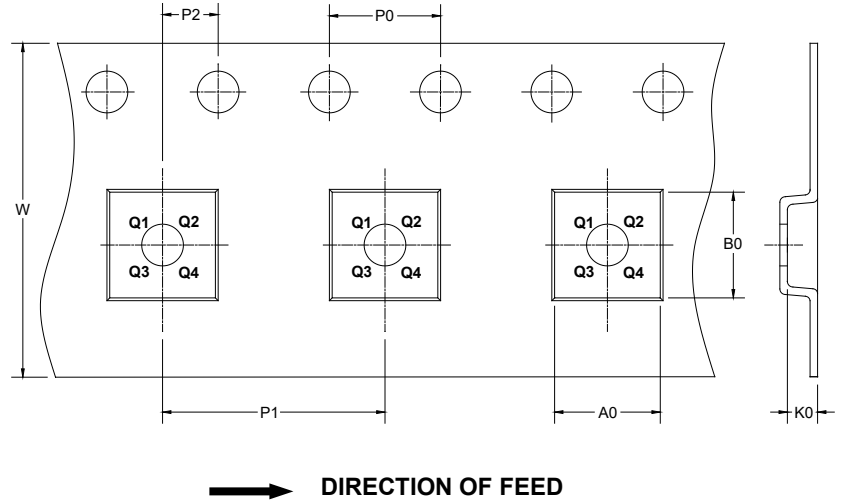

NOTE: The picture is only for reference. Please make the object as the standard.

KEY PARAMETER LIST OF TAPE AND REEL

Package Type	Reel Diameter	Reel Width W1 (mm)	A0 (mm)	B0 (mm)	K0 (mm)	P0 (mm)	P1 (mm)	P2 (mm)	W (mm)	Pin1 Quadrant
SOT-23-5	7"	9.5	3.20	3.20	1.40	4.0	4.0	2.0	8.0	Q3
SOIC-8	13"	12.4	6.40	5.40	2.10	4.0	8.0	2.0	12.0	Q1
MSOP-8	13"	12.4	5.20	3.30	1.50	4.0	8.0	2.0	12.0	Q1

DD0001

PACKAGE INFORMATION

CARTON BOX DIMENSIONS



NOTE: The picture is only for reference. Please make the object as the standard.

KEY PARAMETER LIST OF CARTON BOX

Reel Type	Length (mm)	Width (mm)	Height (mm)	Pizza/Carton
7" (Option)	368	227	224	8
7"	442	410	224	18
13"	386	280	370	5

DD0002

单击下面可查看定价，库存，交付和生命周期等信息

[>>SGMICRO\(圣邦微电子\)](#)