



# SGM8925/SGM8927

## 110kHz, 6.4 $\mu$ A, Rail-to-Rail Output CMOS Operational Amplifiers

### GENERAL DESCRIPTION

The SGM8925 (single) and SGM8927 (single with shutdown) are low offset voltage, low power, voltage feedback amplifiers. These devices can operate from 1.6V to 5.5V single supply, while consuming only 6.4 $\mu$ A quiescent current. They provide a wide input common mode voltage range and rail-to-rail output voltage swing. This feature makes SGM8925/7 appropriate for buffering ASIC.

The SGM8925/7 offer a gain-bandwidth product of 100kHz and an ultra-low input bias current of 1pA. They are well suited for piezoelectric sensors, integrators and photodiode amplifiers.

The SGM8925/7 are designed into a wide range of applications, such as battery-powered instrumentation, safety monitoring, portable systems, and transducer interface circuits in low power systems.

The SGM8925 is available in Green SOT-23-5, SC70-5, MSOP-8 and SOIC-8 packages. The SGM8927 is available in Green SOT-23-6, MSOP-8 and SOIC-8 packages. They are specified over the extended -40°C to +85°C temperature range.

### FEATURES

- **Low Offset Voltage: 0.6mV (MAX)**
- **Unity-Gain Stable**
- **Gain-Bandwidth Product: 110kHz**
- **Rail-to-Rail Output**
- **Supply Voltage Range: 1.6V to 5.5V**
- **Low Supply Current: 6.4 $\mu$ A (TYP)**
- **-40°C to +85°C Operating Temperature Range**
- **Small Packaging:**
  - SGM8925 Available in Green SOT-23-5, SC70-5, SOIC-8 and MSOP-8 Packages**
  - SGM8927 Available in Green SOT-23-6, SOIC-8 and MSOP-8 Packages**

### APPLICATIONS

ASIC Input or Output Amplifiers  
Piezoelectric Transducer Amplifiers  
Battery-Powered Equipment  
Portable Systems  
Sensor Interfaces  
Medical Instrumentation  
Mobile Communications  
Audio Outputs  
Smoke Detectors  
Mobile Telephones  
Notebook PCs  
PCMCIA Cards

**PACKAGE/ORDERING INFORMATION**

MODEL	PACKAGE DESCRIPTION	SPECIFIED TEMPERATURE RANGE	ORDERING NUMBER	PACKAGE MARKING	PACKING OPTION
SGM8925	SC70-5	-40°C to +85°C	SGM8925YC5G/TR	SACXX	Tape and Reel, 3000
	SOT-23-5	-40°C to +85°C	SGM8925AYN5G/TR	SADXX	Tape and Reel, 3000
	SC70-5	-40°C to +85°C	SGM8925BYC5G/TR	ST9XX	Tape and Reel, 3000
	SOT-23-5	-40°C to +85°C	SGM8925BYN5G/TR	SAEXX	Tape and Reel, 3000
	SOIC-8	-40°C to +85°C	SGM8925YS8G/TR	SGM 8925YS8 XXXXX	Tape and Reel, 2500
	MSOP-8	-40°C to +85°C	SGM8925YMS8G/TR	SGM8925 YMS8 XXXXX	Tape and Reel, 3000
SGM8927	SOT-23-6	-40°C to +85°C	SGM8927YN6G/TR	SAFXX	Tape and Reel, 3000
	SOIC-8	-40°C to +85°C	SGM8927YS8G/TR	SGM 8927YS8 XXXXX	Tape and Reel, 2500
	MSOP-8	-40°C to +85°C	SGM8927YMS8G/TR	SGM8927 YMS8 XXXXX	Tape and Reel, 3000

**MARKING INFORMATION**

NOTE: XX = Date Code. XXXXX = Date Code and Vendor Code.

**SC70-5/SOT-23-5/SOT-23-6**

**YYY X X**

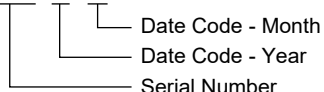

**SOIC-8/MSOP-8**

**XXXXX**

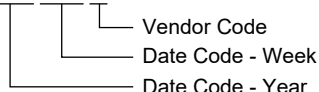

Green (RoHS & HSF): SG Micro Corp defines "Green" to mean Pb-Free (RoHS compatible) and free of halogen substances. If you have additional comments or questions, please contact your SGMICRO representative directly.

# SGM8925 SGM8927

# 110kHz, 6.4µA, Rail-to-Rail Output CMOS Operational Amplifiers

## ABSOLUTE MAXIMUM RATINGS

Supply Voltage, +Vs to -Vs .....	6V
Input Common Mode Voltage Range .....	(-Vs) - 0.1V to (+Vs) - 1.3V
Junction Temperature .....	+150°C
Storage Temperature Range .....	-65°C to +150°C
Lead Temperature (Soldering, 10s) .....	+260°C
ESD Susceptibility	
HBM .....	4000V
MM .....	400V

## RECOMMENDED OPERATING CONDITIONS

Operating Temperature Range .....	-40°C to +85°C
-----------------------------------	----------------

## OVERSTRESS CAUTION

Stresses beyond those listed in Absolute Maximum Ratings may cause permanent damage to the device. Exposure to absolute maximum rating conditions for extended periods

may affect reliability. Functional operation of the device at any conditions beyond those indicated in the Recommended Operating Conditions section is not implied.

## ESD SENSITIVITY CAUTION

This integrated circuit can be damaged if ESD protections are not considered carefully. SGMICRO recommends that all integrated circuits be handled with appropriate precautions. Failure to observe proper handling and installation procedures can cause damage. ESD damage can range from subtle performance degradation to complete device failure. Precision integrated circuits may be more susceptible to damage because even small parametric changes could cause the device not to meet the published specifications.

## DISCLAIMER

SG Micro Corp reserves the right to make any change in circuit design, or specifications without prior notice.

## PIN CONFIGURATIONS

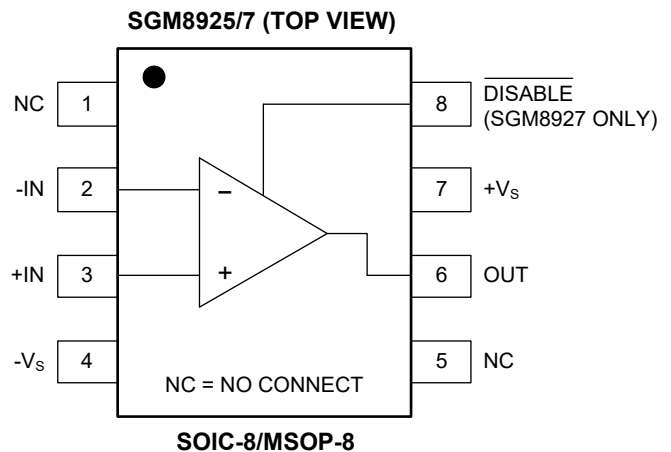
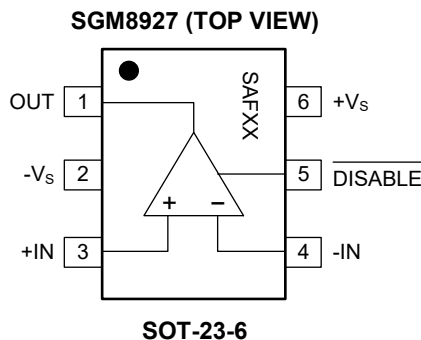
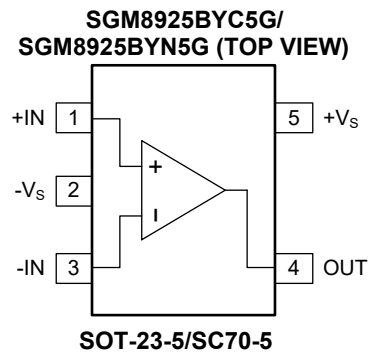
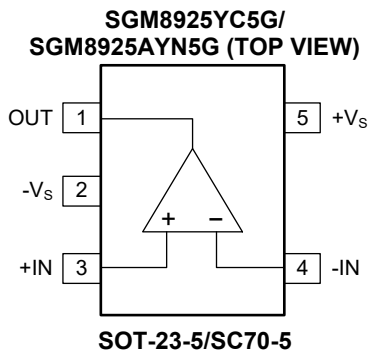

NOTE: The location of pin 1 on the SOT-23-6 is determined by orienting the package marking as shown.

## ELECTRICAL CHARACTERISTICS

(At  $T_A = +25^\circ\text{C}$ ,  $V_S = 5\text{V}$ ,  $V_{OUT} = V_S/2$ , Full =  $-40^\circ\text{C}$  to  $+85^\circ\text{C}$ , unless otherwise noted.)

PARAMETER	CONDITIONS	TEMP	MIN	TYP	MAX	UNITS
<b>DC Performance</b>						
Input Offset Voltage ( $V_{OS}$ )	$V_{CM} = V_S/2$	+25°C		0.13	0.6	mV
		+25°C	SGM8925YC5G only		0.75	
Input Offset Voltage Drift ( $\Delta V_{OS}/\Delta T$ )		Full		2.5		$\mu\text{V}/^\circ\text{C}$
Open-Loop Voltage Gain ( $A_{OL}$ )	$R_L = 100\text{k}\Omega$ to $V_S/2$ , $V_{OUT} = 0.05\text{V}$ to $4.95\text{V}$	+25°C		93		dB
		+25°C	80	88		
		Full	78			
<b>Input Characteristics</b>						
Common Mode Rejection Ratio (CMRR)	$V_{CM} = -0.1\text{V}$ to $3.7\text{V}$	+25°C	70	85		dB
		Full	68			
<b>Output Characteristics</b>						
Output Voltage Swing from Rail	$R_L = 10\text{k}\Omega$ to $V_S/2$	+25°C		21	36	mV
		Full			40	
	$R_L = 2\text{k}\Omega$ to $V_S/2$	+25°C		80	100	
		Full			110	
Output Short-Circuit Current ( $I_{SC}$ )	$R_L = 10\Omega$ to $V_S/2$	+25°C	29	36		mA
		Full	23			
<b>Power-Down (SGM8927 Only)</b>						
Logic Low Voltage ( $V_{IL}$ )		+25°C			0.8	V
Logic High Voltage ( $V_{IH}$ )		+25°C	2			
<b>Power Supply</b>						
Quiescent Current ( $I_Q$ )	$I_{OUT} = 0\text{mA}$	+25°C		6.4	11.5	$\mu\text{A}$
		Full			13.5	
Supply Current when Disabled (SGM8927 Only)		+25°C		0.1	1.5	$\mu\text{A}$
Power Supply Rejection Ratio (PSRR)	$V_S = 1.6\text{V}$ to $5.5\text{V}$ , $V_{CM} = 0.3\text{V}$	+25°C	64	77		dB
		Full	62			
<b>Dynamic Performance</b>						
Gain-Bandwidth Product (GBP)	$R_L = 100\text{k}\Omega$ , $C_L = 100\text{pF}$ , $V_{CM} = 2.5\text{V}$	+25°C		110		kHz
Slew Rate (SR)	$V_{CM} = 2.5\text{V}$	+25°C		0.04		$\text{V}/\mu\text{s}$
<b>Noise Performance</b>						
Input Voltage Noise Density ( $e_n$ )	$f = 1\text{kHz}$	+25°C		105		$\text{nV}/\sqrt{\text{Hz}}$

**ELECTRICAL CHARACTERISTICS (continued)**

(At T<sub>A</sub> = +25°C, V<sub>S</sub> = 1.6V, V<sub>CM</sub> = 0.3V, V<sub>OUT</sub> = V<sub>S</sub>/2, Full = -40°C to +85°C, unless otherwise noted.)

PARAMETER	CONDITIONS	TEMP	MIN	TYP	MAX	UNITS	
<b>DC Performance</b>							
Input Offset Voltage (V <sub>OS</sub> )		+25°C		0.28	0.6	mV	
	SGM8925YC5G only	+25°C			0.75		
Input Offset Voltage Drift (ΔV <sub>OS</sub> /ΔT)		Full		1.8		μV/°C	
Open-Loop Voltage Gain (A <sub>OL</sub> )	R <sub>L</sub> = 100kΩ to V <sub>S</sub> /2, V <sub>OUT</sub> = 0.05V to 1.55V	+25°C		99		dB	
	R <sub>L</sub> = 10kΩ to V <sub>S</sub> /2, V <sub>OUT</sub> = 0.15V to 1.45V	+25°C	80	91			
		Full	78				
<b>Input Characteristics</b>							
Common Mode Rejection Ratio (CMRR)	V <sub>CM</sub> = -0.1V to 0.3V	+25°C	65	78		dB	
		Full	62				
<b>Output Characteristics</b>							
Output Voltage Swing from Rail	R <sub>L</sub> = 10kΩ to V <sub>S</sub> /2	+25°C		13	25	mV	
		Full			30		
	R <sub>L</sub> = 2kΩ to V <sub>S</sub> /2	+25°C		63	87		
		Full			95		
Output Short-Circuit Current (I <sub>SC</sub> )	R <sub>L</sub> = 10Ω to V <sub>S</sub> /2	+25°C	0.5	2.6		mA	
		SGM8925YC5G only	+25°C	0.35			
		Full	0.3				
<b>Power-Down (SGM8927 Only)</b>							
Logic Low Voltage (V <sub>IL</sub> )		+25°C			0.4	V	
Logic High Voltage (V <sub>IH</sub> )		+25°C	1.1				
<b>Power Supply</b>							
Quiescent Current (I <sub>Q</sub> )	I <sub>OUT</sub> = 0mA	+25°C		5.8	10.5	μA	
		Full			13		
Supply Current when Disabled (SGM8927 Only)		+25°C		0.1	1.5	μA	
<b>Dynamic Performance</b>							
Gain-Bandwidth Product (GBP)	R <sub>L</sub> = 100kΩ, C <sub>L</sub> = 100pF	+25°C		110		kHz	
Slew Rate (SR)		+25°C		0.04		V/μs	
<b>Noise Performance</b>							
Input Voltage Noise Density (e <sub>n</sub> )	f = 1kHz	+25°C		105		nV/√Hz	

**TYPICAL PERFORMANCE CHARACTERISTICS**

At  $T_A = +25^\circ\text{C}$ ,  $V_S = 5\text{V}$ , unless otherwise noted.

Small Signal Step Response

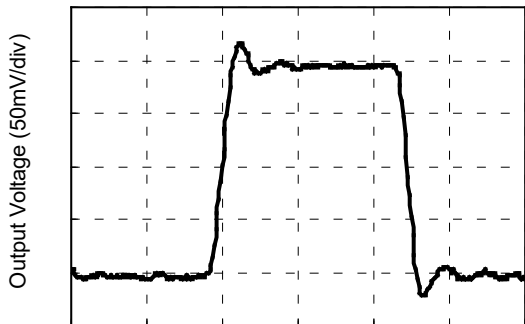

Time (20μs/div)

Large Signal Step Response

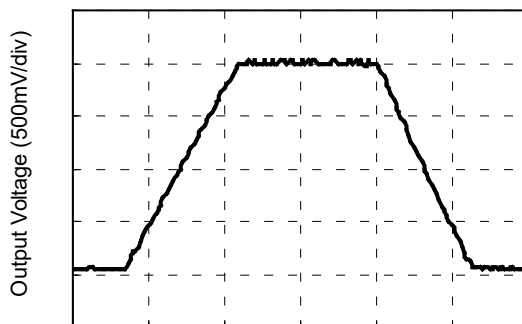

Time (30μs/div)

CMRR and PSRR vs. Frequency

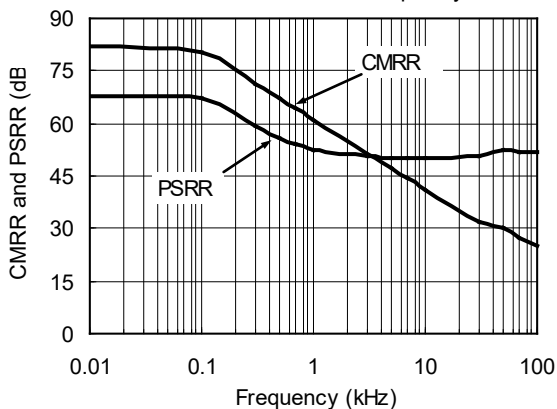

Input Voltage Noise Spectral Density vs. Frequency

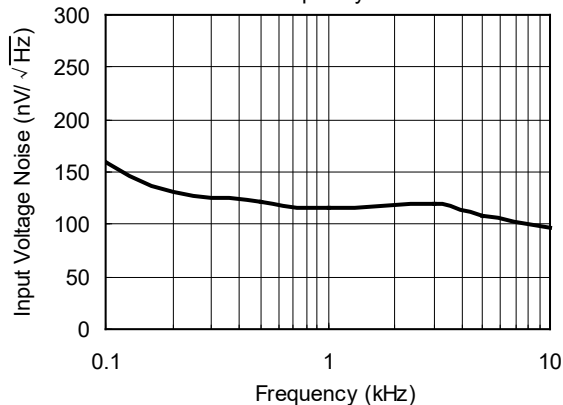

Quiescent Current vs. Temperature

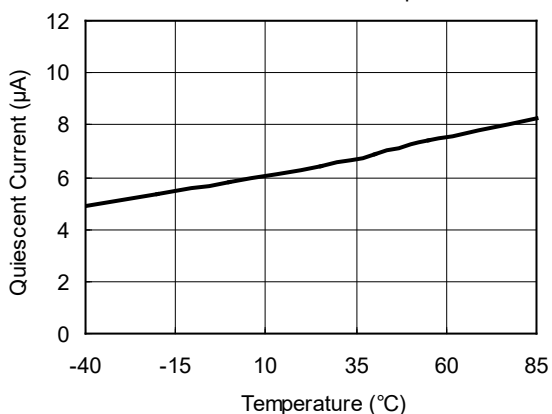

Open-Loop Voltage Gain vs. Temperature

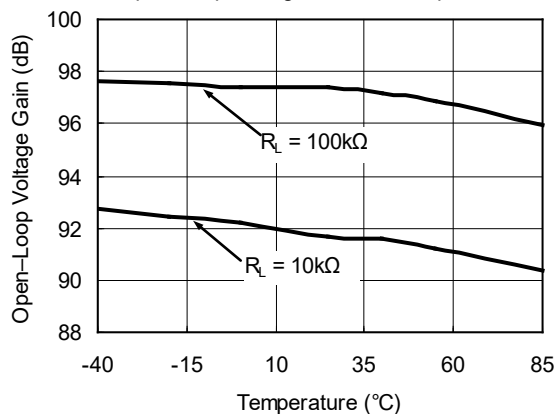

**TYPICAL PERFORMANCE CHARACTERISTICS (continued)**

At  $T_A = +25^\circ\text{C}$ ,  $V_S = 5\text{V}$ , unless otherwise noted.

Common Mode Rejection Ratio vs. Temperature

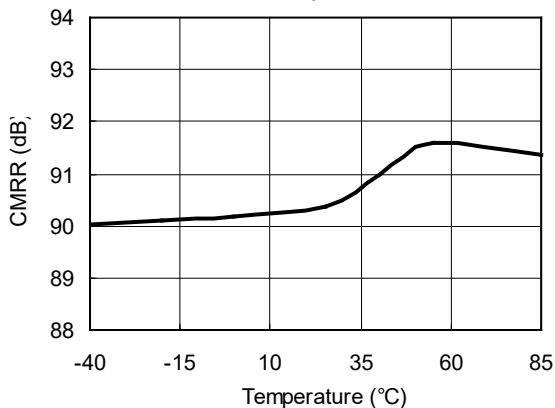

Power Supply Rejection Ratio vs. Temperature

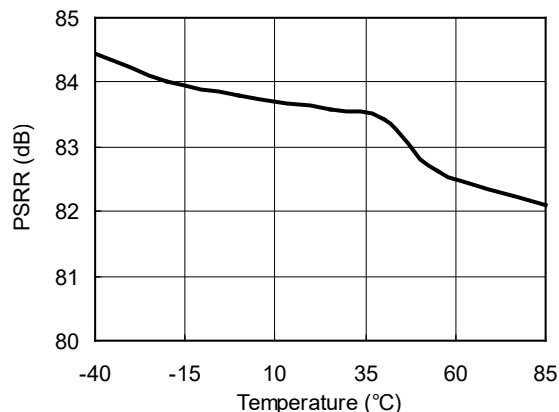

Supply Current vs. Supply Voltage

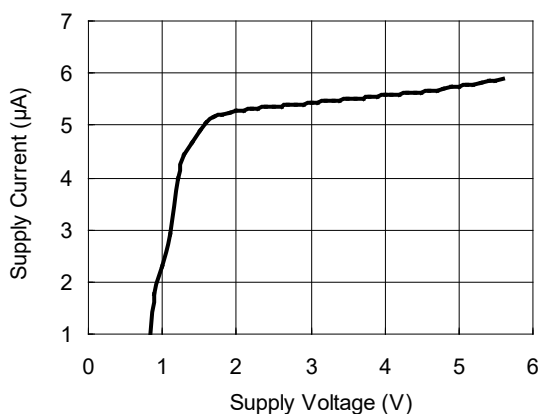

Output Voltage vs. Output Current

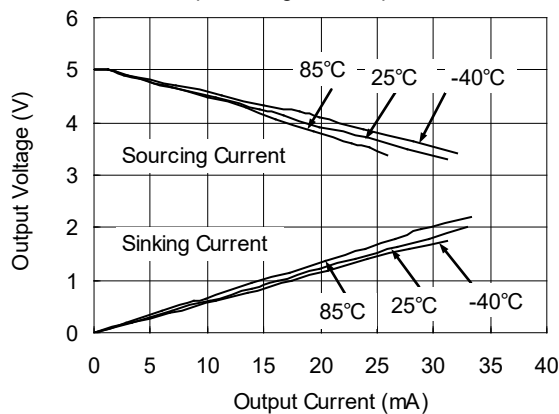

Small Signal Disable/Enable Response

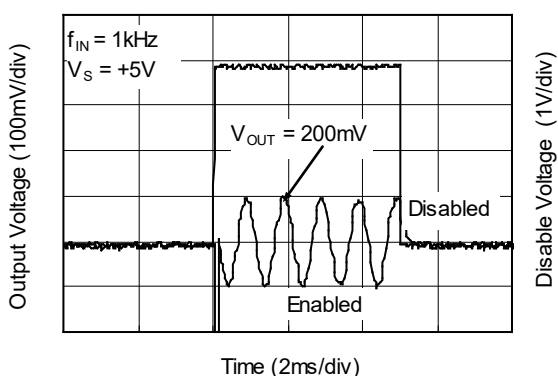

0.1Hz to 10Hz Noise at +5V

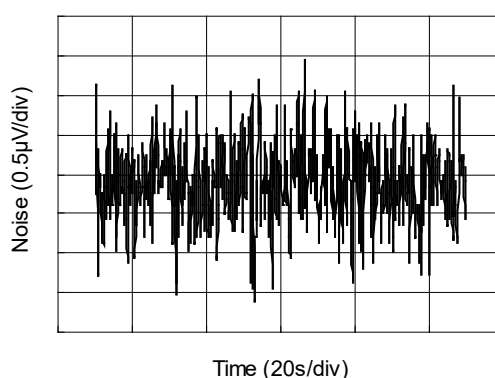

**TYPICAL PERFORMANCE CHARACTERISTICS (continued)**

At  $T_A = +25^\circ\text{C}$ ,  $V_S = 5\text{V}$ , unless otherwise noted.

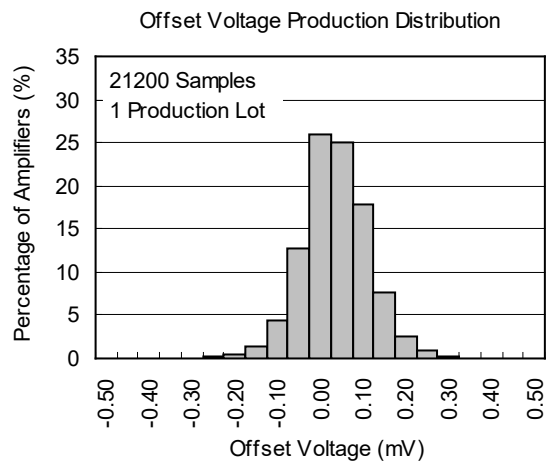
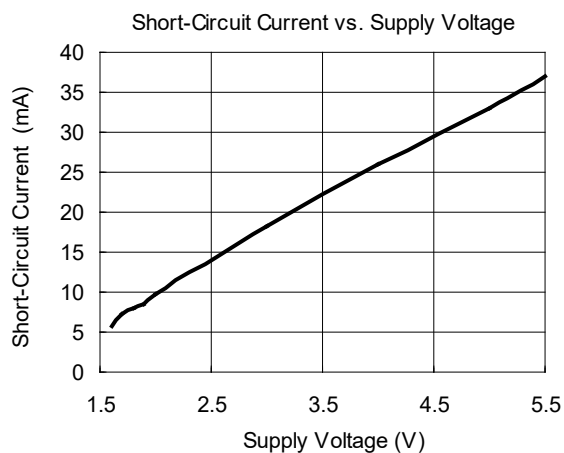
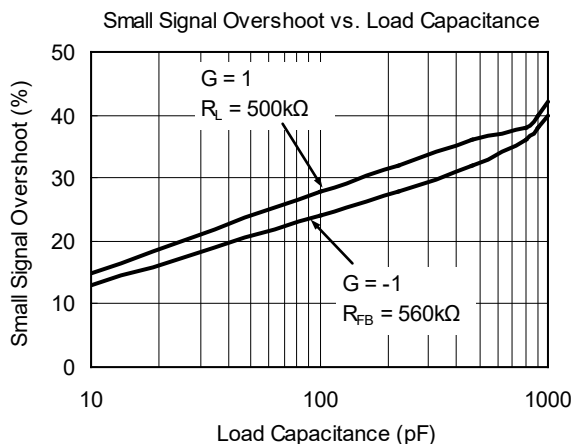



## REVISION HISTORY

NOTE: Page numbers for previous revisions may differ from page numbers in the current version.

<b>DECEMBER 2014 – REV.A.2 to REV.A.3</b>	<b>Page</b>
Added SC70-5 Package from product preview to production data .....	1
Added Ordering Information of SC70-5 package for SGM8925 .....	2
Added SC70-5 package for SGM8925 .....	3
<b>DECEMBER 2013 – REV.A.1 to REV.A.2</b>	<b>Page</b>
Changed Electrical Characteristics section .....	5
Added input offset voltage ( $V_{OS}$ ) max value of SGM8925YC5G .....	5
Changed Electrical Characteristics section .....	6
Added input offset voltage ( $V_{OS}$ ) max value of SGM8925YC5G .....	6
Added output short-circuit current ( $I_{SC}$ ) min value of SGM8925YC5G .....	6
Changed output short-circuit current ( $I_{SC}$ ) min value from 0.4V to 0.3V .....	6
<b>MAY 2013 – REV.A to REV.A.1</b>	<b>Page</b>
Changed Electrical Characteristics section .....	5
Deleted open-loop voltage gain ( $A_{OL}$ ) min value in $R_L = 100k\Omega$ to $V_S/2$ test condition .....	5
Changed Electrical Characteristics section .....	6
Deleted open-loop voltage gain ( $A_{OL}$ ) min value in $R_L = 100k\Omega$ to $V_S/2$ test condition .....	6
<b>Changes from Original (AUGUST 2012) to REV.A</b>	<b>Page</b>
Changed from product preview to production data .....	All

PACKAGE OUTLINE DIMENSIONS

SC70-5

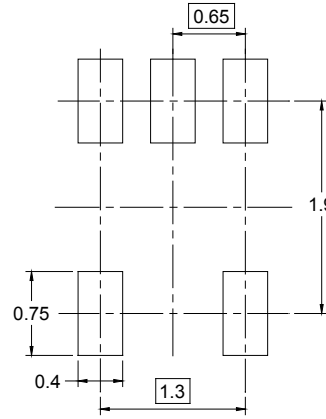
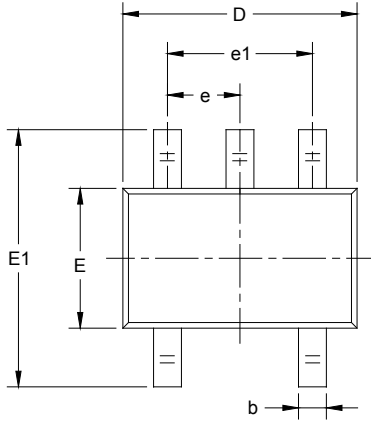

RECOMMENDED LAND PATTERN (Unit: mm)

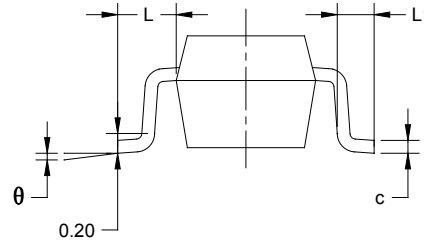
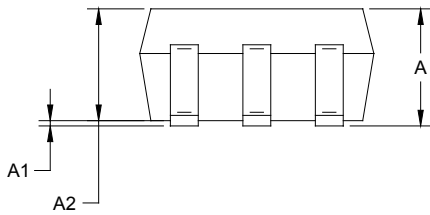

Symbol	Dimensions In Millimeters		Dimensions In Inches	
	MIN	MAX	MIN	MAX
A	0.900	1.100	0.035	0.043
A1	0.000	0.100	0.000	0.004
A2	0.900	1.000	0.035	0.039
b	0.150	0.350	0.006	0.014
c	0.080	0.150	0.003	0.006
D	2.000	2.200	0.079	0.087
E	1.150	1.350	0.045	0.053
E1	2.150	2.450	0.085	0.096
e	0.65 TYP		0.026 TYP	
e1	1.300 BSC		0.051 BSC	
L	0.525 REF		0.021 REF	
L1	0.260	0.460	0.010	0.018
$\theta$	0°	8°	0°	8°

# PACKAGE INFORMATION

## PACKAGE OUTLINE DIMENSIONS

### SOT-23-5

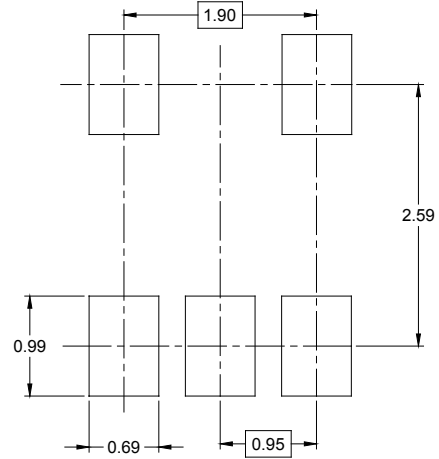

RECOMMENDED LAND PATTERN (Unit: mm)



Symbol	Dimensions In Millimeters		Dimensions In Inches	
	MIN	MAX	MIN	MAX
A	1.050	1.250	0.041	0.049
A1	0.000	0.100	0.000	0.004
A2	1.050	1.150	0.041	0.045
b	0.300	0.500	0.012	0.020
c	0.100	0.200	0.004	0.008
D	2.820	3.020	0.111	0.119
E	1.500	1.700	0.059	0.067
E1	2.650	2.950	0.104	0.116
e	0.950 BSC		0.037 BSC	
e1	1.900 BSC		0.075 BSC	
L	0.300	0.600	0.012	0.024
$\theta$	0°	8°	0°	8°

PACKAGE OUTLINE DIMENSIONS

SOT-23-6

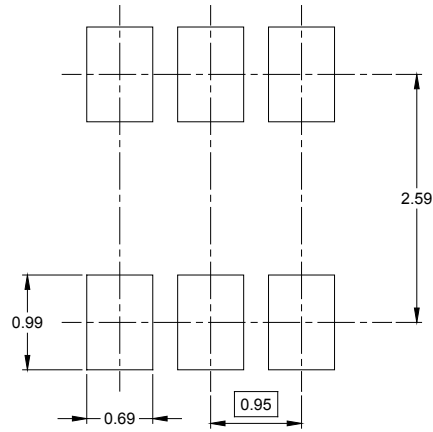
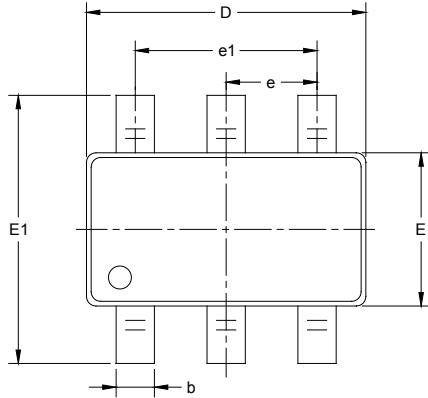

RECOMMENDED LAND PATTERN (Unit: mm)

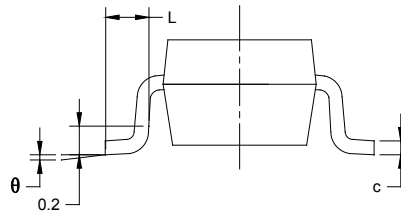
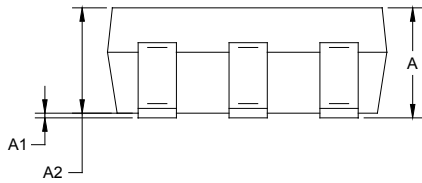

Symbol	Dimensions In Millimeters		Dimensions In Inches	
	MIN	MAX	MIN	MAX
A	1.050	1.250	0.041	0.049
A1	0.000	0.100	0.000	0.004
A2	1.050	1.150	0.041	0.045
b	0.300	0.500	0.012	0.020
c	0.100	0.200	0.004	0.008
D	2.820	3.020	0.111	0.119
E	1.500	1.700	0.059	0.067
E1	2.650	2.950	0.104	0.116
e	0.950 BSC		0.037 BSC	
e1	1.900 BSC		0.075 BSC	
L	0.300	0.600	0.012	0.024
$\theta$	0°	8°	0°	8°

PACKAGE OUTLINE DIMENSIONS

SOIC-8

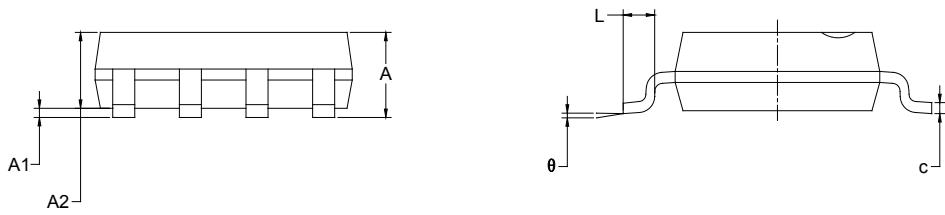
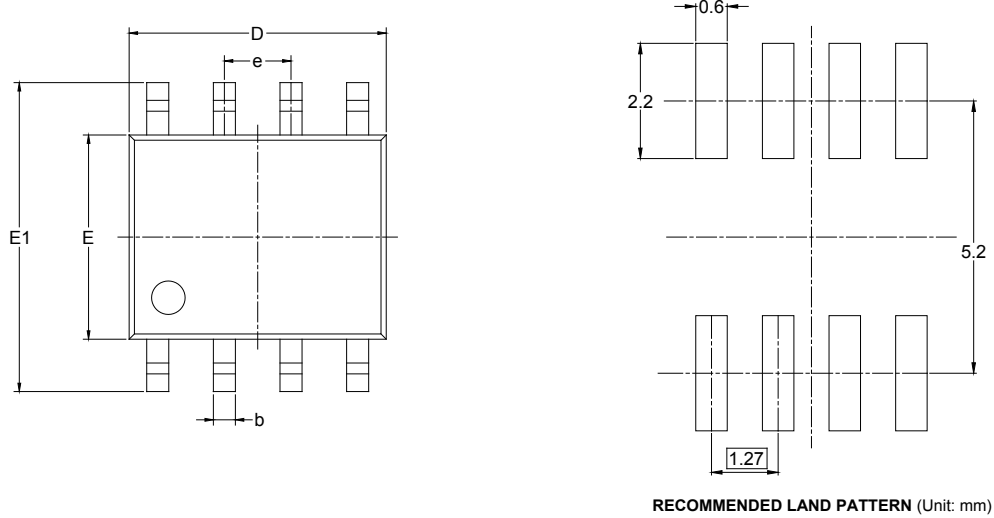

Symbol	Dimensions In Millimeters		Dimensions In Inches	
	MIN	MAX	MIN	MAX
A	1.350	1.750	0.053	0.069
A1	0.100	0.250	0.004	0.010
A2	1.350	1.550	0.053	0.061
b	0.330	0.510	0.013	0.020
c	0.170	0.250	0.006	0.010
D	4.700	5.100	0.185	0.200
E	3.800	4.000	0.150	0.157
E1	5.800	6.200	0.228	0.244
e	1.27 BSC		0.050 BSC	
L	0.400	1.270	0.016	0.050
θ	0°	8°	0°	8°

PACKAGE OUTLINE DIMENSIONS

MSOP-8

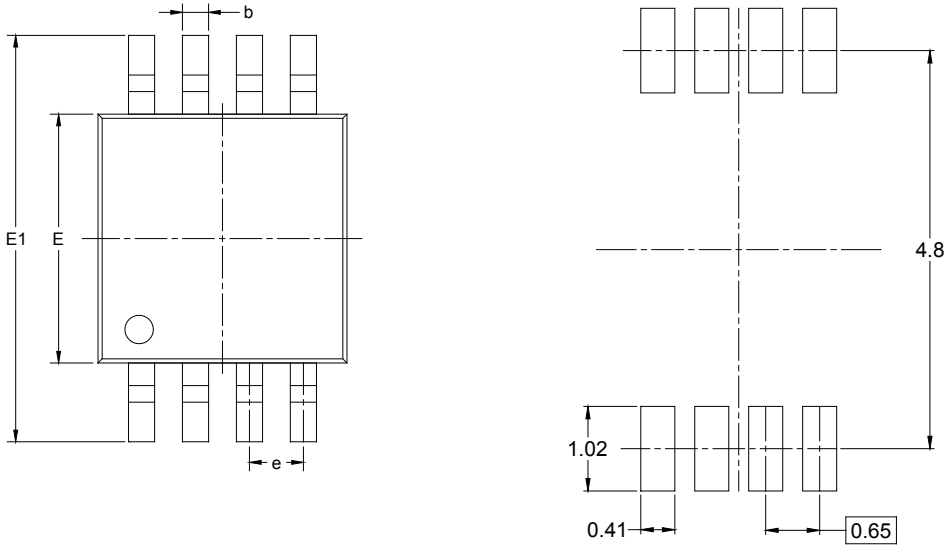

RECOMMENDED LAND PATTERN (Unit: mm)

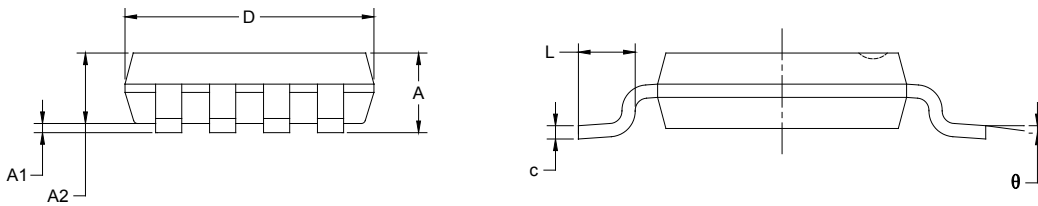

Symbol	Dimensions In Millimeters		Dimensions In Inches	
	MIN	MAX	MIN	MAX
A	0.820	1.100	0.032	0.043
A1	0.020	0.150	0.001	0.006
A2	0.750	0.950	0.030	0.037
b	0.250	0.380	0.010	0.015
c	0.090	0.230	0.004	0.009
D	2.900	3.100	0.114	0.122
E	2.900	3.100	0.114	0.122
E1	4.750	5.050	0.187	0.199
e	0.650 BSC		0.026 BSC	
L	0.400	0.800	0.016	0.031
θ	0°	6°	0°	6°

# PACKAGE INFORMATION

## TAPE AND REEL INFORMATION

### REEL DIMENSIONS



### TAPE DIMENSIONS



NOTE: The picture is only for reference. Please make the object as the standard.

### KEY PARAMETER LIST OF TAPE AND REEL

Package Type	Reel Diameter	Reel Width W1 (mm)	A0 (mm)	B0 (mm)	K0 (mm)	P0 (mm)	P1 (mm)	P2 (mm)	W (mm)	Pin1 Quadrant
SC70-5	7"	9.5	2.25	2.55	1.20	4.0	4.0	2.0	8.0	Q3
SOT-23-5	7"	9.5	3.20	3.20	1.40	4.0	4.0	2.0	8.0	Q3
SOT-23-6	7"	9.5	3.17	3.23	1.37	4.0	4.0	2.0	8.0	Q3
SOIC-8	13"	12.4	6.40	5.40	2.10	4.0	8.0	2.0	12.0	Q1
MSOP-8	13"	12.4	5.20	3.30	1.50	4.0	8.0	2.0	12.0	Q1

D20001

# PACKAGE INFORMATION

## CARTON BOX DIMENSIONS



NOTE: The picture is only for reference. Please make the object as the standard.

## KEY PARAMETER LIST OF CARTON BOX

Reel Type	Length (mm)	Width (mm)	Height (mm)	Pizza/Carton
7" (Option)	368	227	224	8
7"	442	410	224	18
13"	386	280	370	5

DD0002



单击下面可查看定价，库存，交付和生命周期等信息

[>>SGMICRO\(圣邦微电子\)](#)