



SGM8931/SGM8932 SGM8933/SGM8934 1.5MHz, Rail-to-Rail Output Operational Amplifiers

GENERAL DESCRIPTION

The SGM8931/2/3/4 are a family of single, dual and quad operational amplifiers designed for 5V operation. These devices can operate from 1.8V to 5.5V single supply. They provide a wide input common mode voltage range and rail-to-rail output voltage swing.

The SGM8931/2/3/4 provide excellent overall performance. They feature low offset, low noise and low distortion. These devices work well in low voltage or battery-powered audio systems requiring high quality.

The SGM8931 is available in Green SOT-23-5, SC70-5, SOIC-8 and MSOP-8 packages. The SGM8932 is available in Green SOIC-8 and MSOP-8 packages. The SGM8933 is available in Green SOT-23-6, SOIC-8 and MSOP-8 packages. The SGM8934 is available in Green SOIC-14 and TSSOP-14 packages. They are specified over the -40°C to +85°C temperature range.

FEATURES

- **Low Input Voltage Noise:** $30\text{nV}/\sqrt{\text{Hz}}$
- **Low Distortion**
- **Low Offset Voltage:** 0.9mV (MAX)
- **Gain-Bandwidth Product:** 1.5MHz
- **Slew Rate:** 0.8V/ μs
- **Rail-to-Rail Output**
- **Supply Voltage Range:** 1.8V to 5.5V
- **Low Supply Current:**
80 μA /Amplifier (TYP)
0.1 μA Shutdown Current for SGM8933
- **-40°C to +85°C Operating Temperature Range**
- **Small Packaging:**
SGM8931 Available in SOT-23-5, SC70-5, SOIC-8 and MSOP-8 Packages
SGM8932 Available in SOIC-8 and MSOP-8 Packages
SGM8933 Available in SOT-23-6, SOIC-8 and MSOP-8 Packages
SGM8934 Available in SOIC-14 and TSSOP-14 Packages

APPLICATIONS

Data Acquisition
Process Control
Active Filter
Test Equipment
Mobile Phone
Audio Processing
Portable Equipment

PACKAGE/ORDERING INFORMATION

MODEL	PACKAGE DESCRIPTION	SPECIFIED TEMPERATURE RANGE	ORDERING NUMBER	PACKAGE MARKING	PACKING OPTION
SGM8931	SOT-23-5	-40°C to +85°C	SGM8931AYN5G/TR	SAAXX	Tape and Reel, 3000
	SOT-23-5	-40°C to +85°C	SGM8931BYN5G/TR	SB1XX	Tape and Reel, 3000
	SC70-5	-40°C to +85°C	SGM8931YC5G/TR	SABXX	Tape and Reel, 3000
	SOIC-8	-40°C to +85°C	SGM8931YS8G/TR	SGM8931YS8 XXXXX	Tape and Reel, 2500
	MSOP-8	-40°C to +85°C	SGM8931YMS8G/TR	SGM8931 YMS8 XXXXX	Tape and Reel, 3000
SGM8932	SOIC-8	-40°C to +85°C	SGM8932YS8G/TR	SGM8932YS8 XXXXX	Tape and Reel, 2500
	MSOP-8	-40°C to +85°C	SGM8932YMS8G/TR	SGM8932 YMS8 XXXXX	Tape and Reel, 3000
SGM8933	SOT-23-6	-40°C to +85°C	SGM8933YN6G/TR	SA8XX	Tape and Reel, 3000
	SOIC-8	-40°C to +85°C	SGM8933YS8G/TR	SGM 8933YS8 XXXXX	Tape and Reel, 2500
	MSOP-8	-40°C to +85°C	SGM8933YMS8G/TR	SGM8933 YMS8 XXXXX	Tape and Reel, 3000
SGM8934	SOIC-14	-40°C to +85°C	SGM8934YS14G/TR	SGM8934YS14 XXXXX	Tape and Reel, 2500
	TSSOP-14	-40°C to +85°C	SGM8934YTS14G/TR	SGM8934 YTS14 XXXXX	Tape and Reel, 3000

MARKING INFORMATION

NOTE: XX = Date Code. XXXXX = Date Code and Vendor Code.

SC70-5/SOT-23-5/SOT-23-6

YYY X X

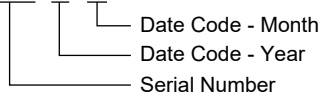

SOIC-8/MSOP-8/SOIC-14/TSSOP-14

XXXXX

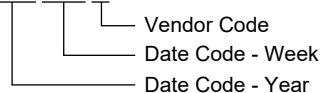

Green (RoHS & HSF): SG Micro Corp defines "Green" to mean Pb-Free (RoHS compatible) and free of halogen substances. If you have additional comments or questions, please contact your SGMICRO representative directly.

ABSOLUTE MAXIMUM RATINGS

Supply Voltage, +Vs to -Vs.....	6V
Common Mode Input Voltage	-0.1V to (+Vs) - 1.3V
Junction Temperature.....	+150°C
Storage Temperature Range	-65°C to +150°C
Lead Temperature (Soldering, 10s).....	+260°C
ESD Susceptibility	
HBM (SGM8931/2/4)	8000V
HBM (SGM8933)	4000V
MM.....	400V

RECOMMENDED OPERATING CONDITIONS

Operating Temperature Range	-40°C to +85°C
-----------------------------------	----------------

OVERSTRESS CAUTION

Stresses beyond those listed in Absolute Maximum Ratings may cause permanent damage to the device. Exposure to absolute maximum rating conditions for extended periods

may affect reliability. Functional operation of the device at any conditions beyond those indicated in the Recommended Operating Conditions section is not implied.

ESD SENSITIVITY CAUTION

This integrated circuit can be damaged if ESD protections are not considered carefully. SGMICRO recommends that all integrated circuits be handled with appropriate precautions. Failure to observe proper handling and installation procedures can cause damage. ESD damage can range from subtle performance degradation to complete device failure. Precision integrated circuits may be more susceptible to damage because even small parametric changes could cause the device not to meet the published specifications.

DISCLAIMER

SG Micro Corp reserves the right to make any change in circuit design, or specifications without prior notice.

PIN CONFIGURATIONS

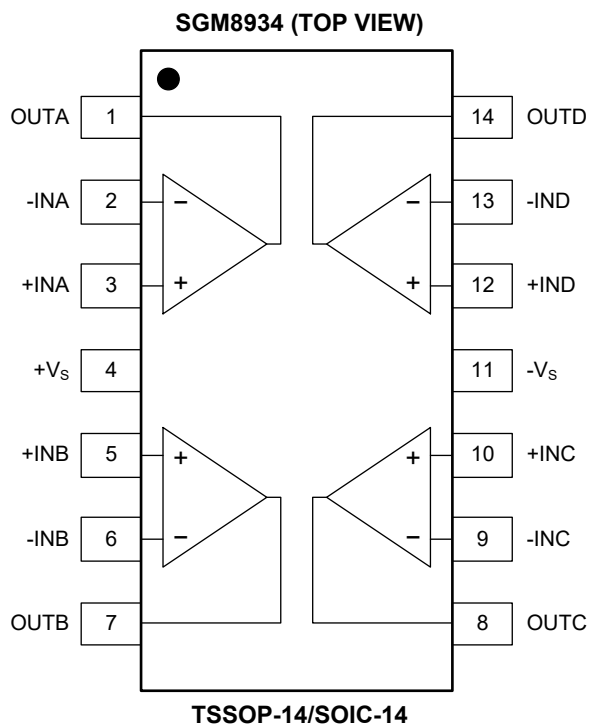
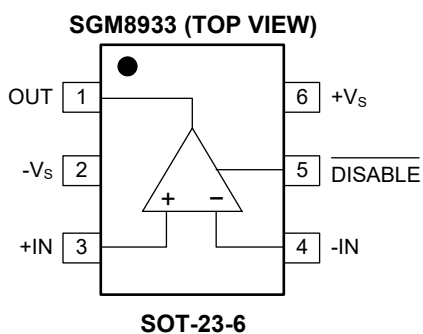
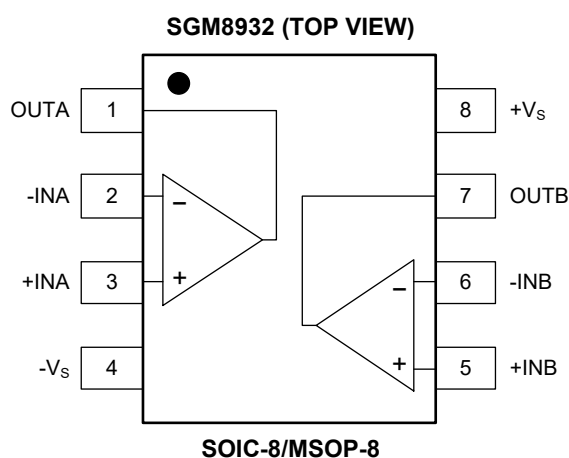
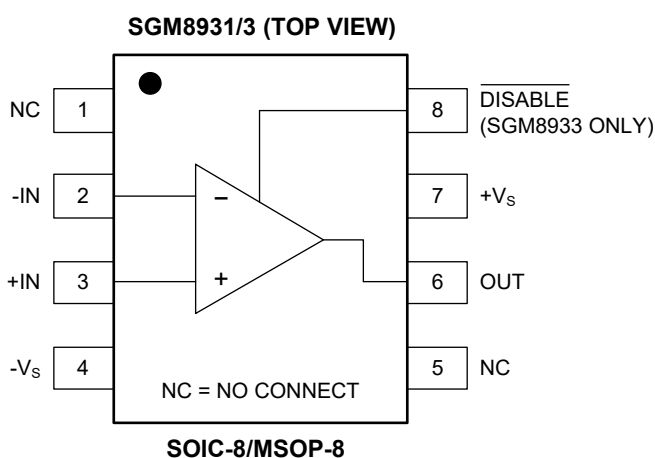
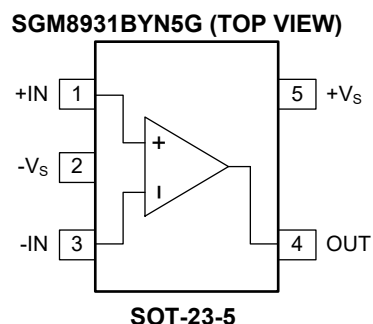
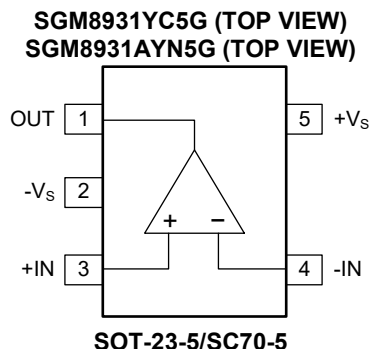

ELECTRICAL CHARACTERISTICS

(At T_A = +25°C, V_S = 5V, V_{OUT} = V_S/2, Full = -40°C to +85°C, unless otherwise noted.)

PARAMETER	CONDITIONS	TEMP	MIN	TYP	MAX	UNITS
DC Performance						
Input Offset Voltage (V _{OS})	V _{CM} = V _S /2	+25°C		0.2	0.9	mV
		Full			1.4	
Input Bias Current (I _b)		+25°C		3		pA
Input Offset Current (I _{OS})		+25°C		3		pA
Input Offset Voltage Drift	V _{CM} = V _S /2	Full		1.5		μV/°C
Open-Loop Gain (A _{OL})	R _L = 2kΩ, V _{OUT} = 0.2V to 4.8V	+25°C	80	90		dB
		Full	76			
	R _L = 100kΩ, V _{OUT} = 0.035V to 4.965V	+25°C		100		
Input Characteristics						
Input Common Mode Voltage Range (V _{CM})		+25°C	-0.1		3.7	V
Common Mode Rejection Ratio (CMRR)	V _{CM} = -0.1V to 3.7V	+25°C	70	86		dB
		Full	67			
Output Characteristics						
Output Voltage Swing from Rail	R _L = 2kΩ	+25°C		80	110	mV
		Full			120	
Output Short-Circuit Current (I _{SC})		+25°C	19	35		mA
		Full	15			
Power-Down (SGM8933 Only)						
Logic Low Voltage (V _{IL})		+25°C			0.8	V
Logic High Voltage (V _{IH})		+25°C	2			
Power Supply						
Quiescent Current/Amplifier	I _{OUT} = 0mA	+25°C		80	130	μA
		Full			150	
Supply Current when Disabled (SGM8933 only)		+25°C		0.1	6	μA
Power Supply Rejection Ratio (PSRR)	V _S = 1.8V to 5.5V, V _{CM} = 0.5V	+25°C	68	80		dB
		Full	64			
Dynamic Performance						
Gain-Bandwidth Product (GBP)	R _L = 2kΩ, C _L = 100pF	+25°C		1.5		MHz
Slew Rate	V _{OUT} = 2V _{PP} , A _V = 1	+25°C		0.8		V/μs
Crosstalk	f = 1kHz	+25°C		110		dB
Settling Time to 0.1% (t _S)	V _{OUT} = 2V _{PP} , f = 1kHz, A _V = 1, R _L = 2kΩ, C _L = 100pF	+25°C		3.5		μs
Overload Recovery Time	R _L = 2kΩ, A _V = -50	+25°C		7		μs
Noise Performance						
Input Voltage Noise Density (e _n)	f = 1kHz	+25°C		30		nV/√Hz

ELECTRICAL CHARACTERISTICS (continued)

(At $T_A = +25^\circ\text{C}$, $V_S = 1.8\text{V}$, $V_{OUT} = V_S/2$, Full = -40°C to $+85^\circ\text{C}$, unless otherwise noted.)

PARAMETER	CONDITIONS	TEMP	MIN	TYP	MAX	UNITS
DC Performance						
Input Offset Voltage (V_{OS})	$V_{CM} = 0.5\text{V}$	$+25^\circ\text{C}$		0.3	0.9	mV
		Full			1.3	
Input Bias Current (I_b)		$+25^\circ\text{C}$		3		pA
Input Offset Current (I_{OS})		$+25^\circ\text{C}$		3		pA
Input Offset Voltage Drift	$V_{CM} = 0.5\text{V}$	Full		1.5		$\mu\text{V}/^\circ\text{C}$
Open-Loop Gain (A_{OL})	$R_L = 2\text{k}\Omega$, $V_{OUT} = 0.2\text{V}$ to 1.6V	$+25^\circ\text{C}$	75	85		dB
		Full	70			
	$R_L = 100\text{k}\Omega$, $V_{OUT} = 0.035\text{V}$ to 1.765V	$+25^\circ\text{C}$		105		
Input Characteristics						
Input Common Mode Voltage Range (V_{CM})		$+25^\circ\text{C}$	-0.1		0.5	V
Common Mode Rejection Ratio (CMRR)	$V_{CM} = -0.1\text{V}$ to 0.5V	$+25^\circ\text{C}$	65	80		dB
		Full	62			
Output Characteristics						
Output Voltage Swing from Rail	$R_L = 2\text{k}\Omega$	$+25^\circ\text{C}$		55	75	mV
		Full			95	
Output Short-Circuit Current (I_{SC})		$+25^\circ\text{C}$	2	5		mA
		Full	1.5			
Power-Down (SGM8933 Only)						
Logic Low Voltage (V_{IL})		$+25^\circ\text{C}$			0.4	V
Logic High Voltage (V_{IH})		$+25^\circ\text{C}$	1.3			
Power Supply						
Quiescent Current/Amplifier	$I_{OUT} = 0\text{mA}$	$+25^\circ\text{C}$		75	125	μA
		Full			145	
Supply Current when Disabled (SGM8933 only)		$+25^\circ\text{C}$		0.01	2	μA
Dynamic Performance						
Gain-Bandwidth Product (GBP)	$R_L = 2\text{k}\Omega$, $C_L = 100\text{pF}$	$+25^\circ\text{C}$		1.3		MHz
Slew Rate	$V_{OUT} = 0.5V_{PP}$, $A_V = 1$	$+25^\circ\text{C}$		0.7		$\text{V}/\mu\text{s}$
Crosstalk	$f = 1\text{kHz}$	$+25^\circ\text{C}$		110		dB
Settling Time to 0.1% (t_S)	$V_{OUT} = 0.5V_{PP}$, $f = 1\text{kHz}$, $A_V = 1$, $R_L = 2\text{k}\Omega$, $C_L = 100\text{pF}$	$+25^\circ\text{C}$		2.5		μs
Overload Recovery Time	$R_L = 2\text{k}\Omega$, $A_V = -50$	$+25^\circ\text{C}$		6		μs
Noise Performance						
Input Voltage Noise Density (e_n)	$f = 1\text{kHz}$	$+25^\circ\text{C}$		35		$\text{nV}/\sqrt{\text{Hz}}$

TYPICAL PERFORMANCE CHARACTERISTICS

At $T_A = +25^\circ\text{C}$, $V_S = 5\text{V}$, unless otherwise noted.

Large Signal Step Response

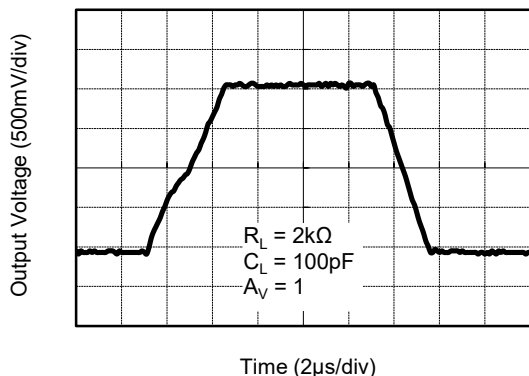

Small Signal Step Response

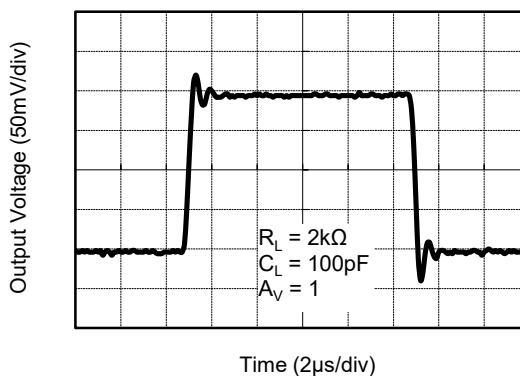

Positive Overvoltage Recovery

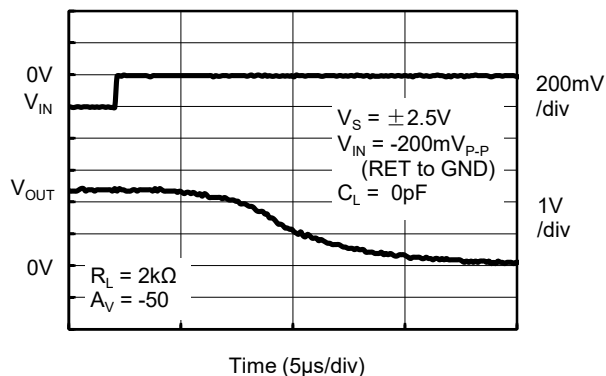

Negative Overvoltage Recovery

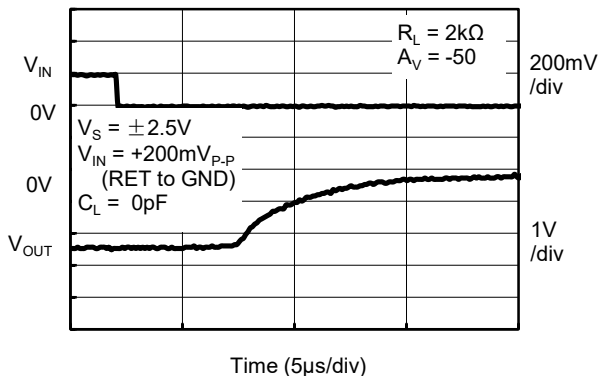

Input Voltage Noise Spectral Density vs. Frequency

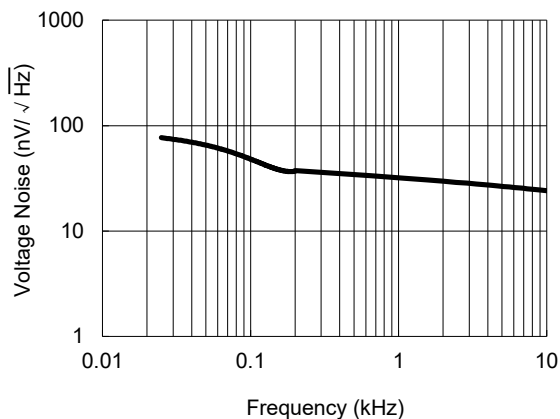

Quiescent Current vs. Temperature

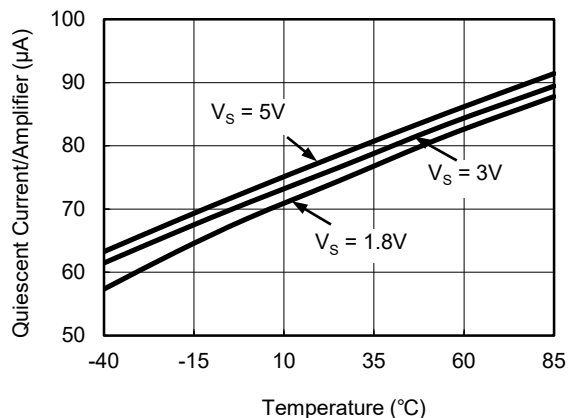

TYPICAL PERFORMANCE CHARACTERISTICS (continued)

At $T_A = +25^\circ\text{C}$, $V_S = 5\text{V}$, unless otherwise noted.

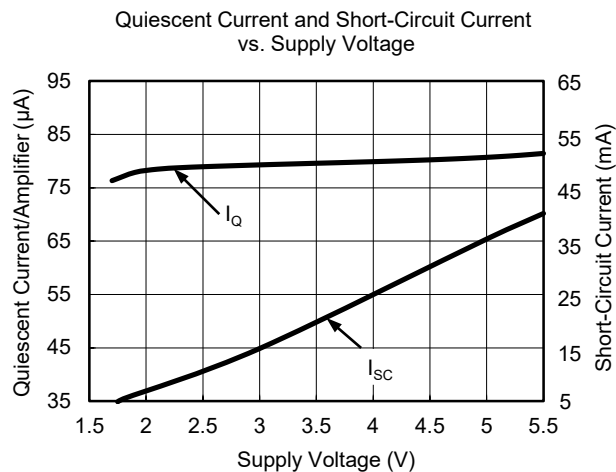
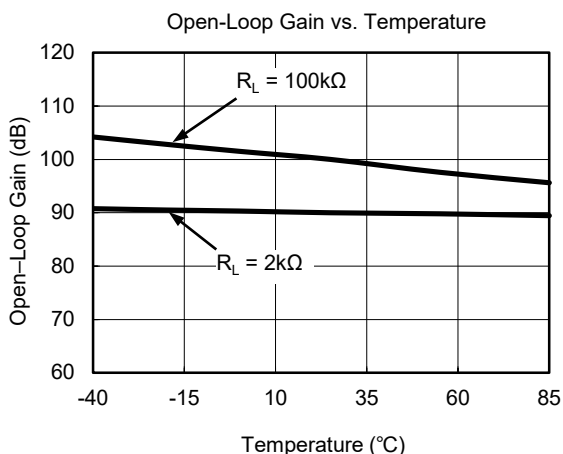
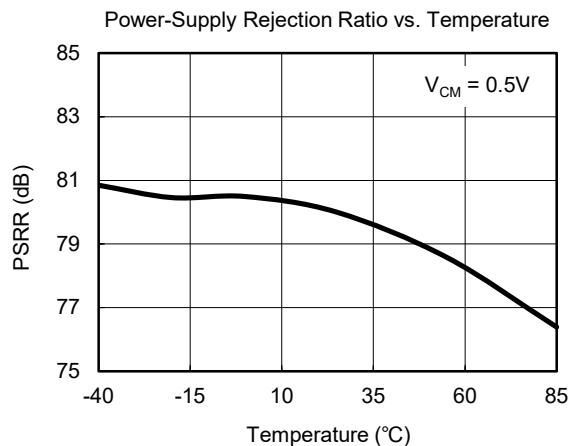
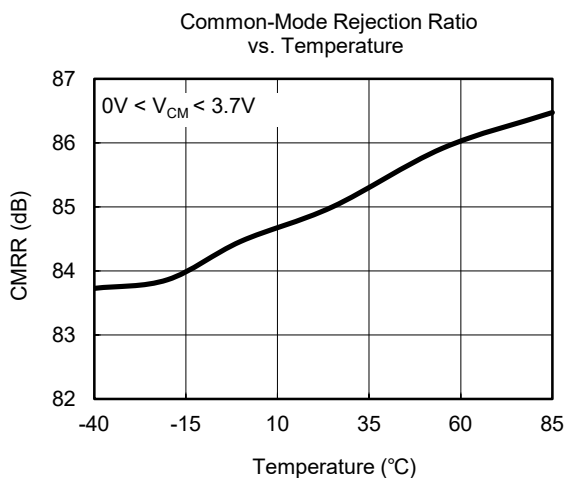

REVISION HISTORY

NOTE: Page numbers for previous revisions may differ from page numbers in the current version.

SEPTEMBER 2013 – REV.A.1 to REV.A.2	Page
Changed Electrical Characteristics section	5, 6

JANUARY 2013 – REV.A to REV.A.1	Page
Added Tape and Reel Information section	15, 16

Changes from Original (APRIL 2012) to REV.A	Page
Changed from product preview to production data	All

PACKAGE OUTLINE DIMENSIONS

SOT-23-5

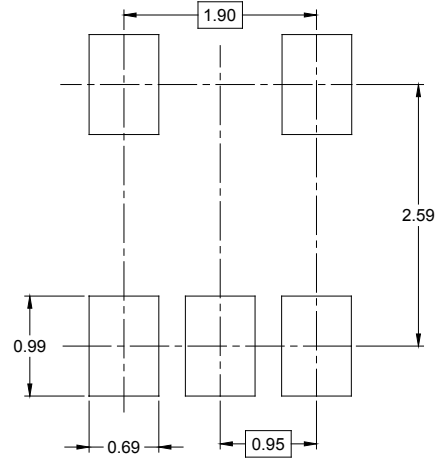

RECOMMENDED LAND PATTERN (Unit: mm)



Symbol	Dimensions In Millimeters		Dimensions In Inches	
	MIN	MAX	MIN	MAX
A	1.050	1.250	0.041	0.049
A1	0.000	0.100	0.000	0.004
A2	1.050	1.150	0.041	0.045
b	0.300	0.500	0.012	0.020
c	0.100	0.200	0.004	0.008
D	2.820	3.020	0.111	0.119
E	1.500	1.700	0.059	0.067
E1	2.650	2.950	0.104	0.116
e	0.950 BSC		0.037 BSC	
e1	1.900 BSC		0.075 BSC	
L	0.300	0.600	0.012	0.024
θ	0°	8°	0°	8°

PACKAGE OUTLINE DIMENSIONS

SC70-5

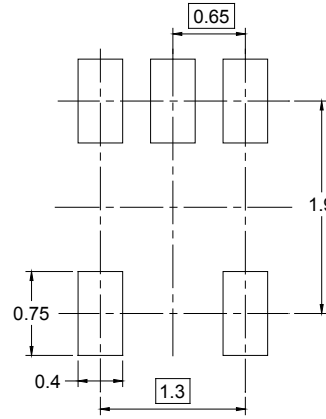
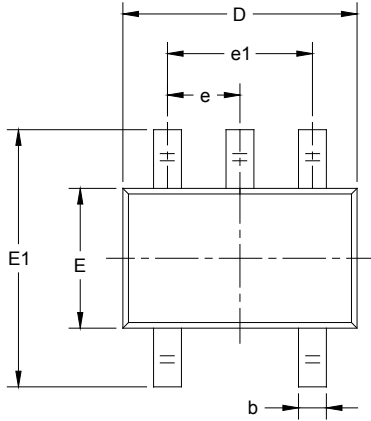

RECOMMENDED LAND PATTERN (Unit: mm)

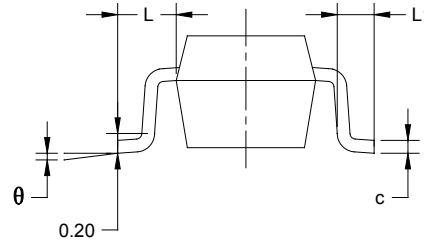
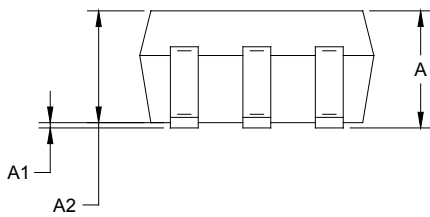

Symbol	Dimensions In Millimeters		Dimensions In Inches	
	MIN	MAX	MIN	MAX
A	0.900	1.100	0.035	0.043
A1	0.000	0.100	0.000	0.004
A2	0.900	1.000	0.035	0.039
b	0.150	0.350	0.006	0.014
c	0.080	0.150	0.003	0.006
D	2.000	2.200	0.079	0.087
E	1.150	1.350	0.045	0.053
E1	2.150	2.450	0.085	0.096
e	0.65 TYP		0.026 TYP	
e1	1.300 BSC		0.051 BSC	
L	0.525 REF		0.021 REF	
L1	0.260	0.460	0.010	0.018
θ	0°	8°	0°	8°

PACKAGE OUTLINE DIMENSIONS

SOT-23-6

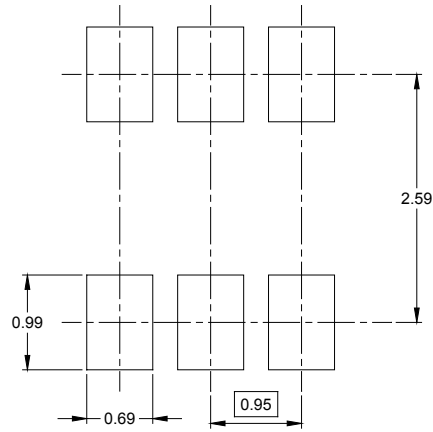
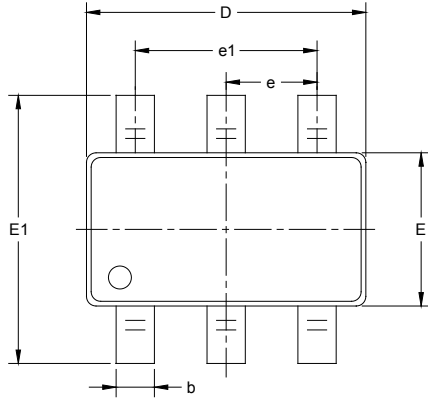

RECOMMENDED LAND PATTERN (Unit: mm)

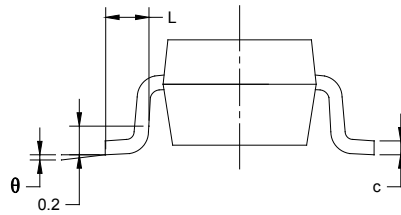
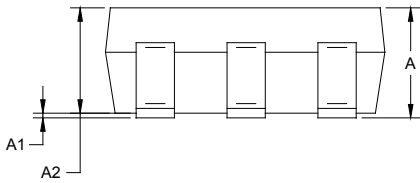

Symbol	Dimensions In Millimeters		Dimensions In Inches	
	MIN	MAX	MIN	MAX
A	1.050	1.250	0.041	0.049
A1	0.000	0.100	0.000	0.004
A2	1.050	1.150	0.041	0.045
b	0.300	0.500	0.012	0.020
c	0.100	0.200	0.004	0.008
D	2.820	3.020	0.111	0.119
E	1.500	1.700	0.059	0.067
E1	2.650	2.950	0.104	0.116
e	0.950 BSC		0.037 BSC	
e1	1.900 BSC		0.075 BSC	
L	0.300	0.600	0.012	0.024
θ	0°	8°	0°	8°

PACKAGE OUTLINE DIMENSIONS

SOIC-8

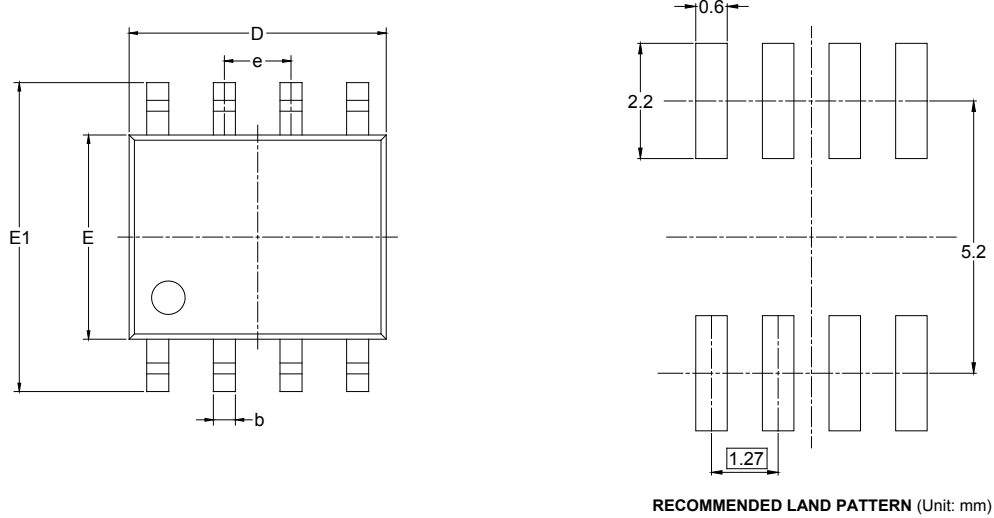

Symbol	Dimensions In Millimeters		Dimensions In Inches	
	MIN	MAX	MIN	MAX
A	1.350	1.750	0.053	0.069
A1	0.100	0.250	0.004	0.010
A2	1.350	1.550	0.053	0.061
b	0.330	0.510	0.013	0.020
c	0.170	0.250	0.006	0.010
D	4.700	5.100	0.185	0.200
E	3.800	4.000	0.150	0.157
E1	5.800	6.200	0.228	0.244
e	1.27 BSC		0.050 BSC	
L	0.400	1.270	0.016	0.050
θ	0°	8°	0°	8°

PACKAGE OUTLINE DIMENSIONS

MSOP-8

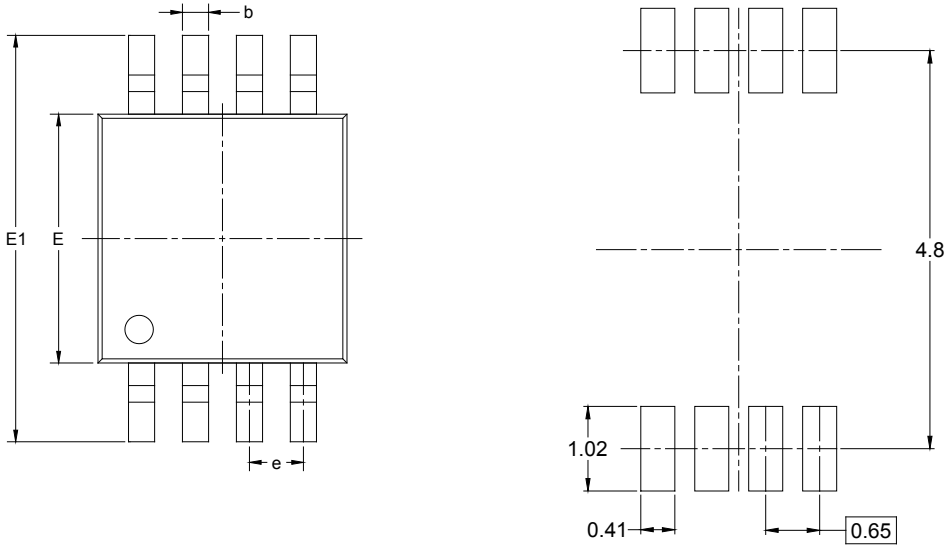

RECOMMENDED LAND PATTERN (Unit: mm)

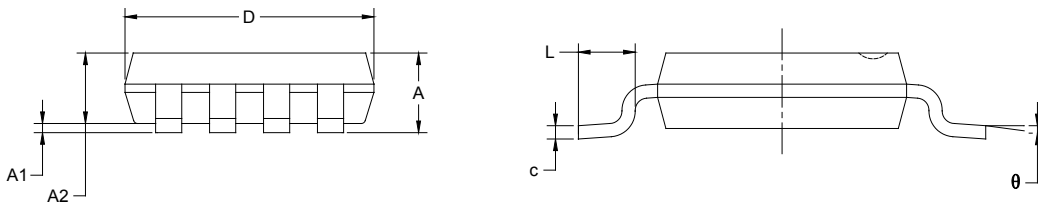

Symbol	Dimensions In Millimeters		Dimensions In Inches	
	MIN	MAX	MIN	MAX
A	0.820	1.100	0.032	0.043
A1	0.020	0.150	0.001	0.006
A2	0.750	0.950	0.030	0.037
b	0.250	0.380	0.010	0.015
c	0.090	0.230	0.004	0.009
D	2.900	3.100	0.114	0.122
E	2.900	3.100	0.114	0.122
E1	4.750	5.050	0.187	0.199
e	0.650 BSC		0.026 BSC	
L	0.400	0.800	0.016	0.031
θ	0°	6°	0°	6°

PACKAGE INFORMATION

PACKAGE OUTLINE DIMENSIONS

SOIC-14

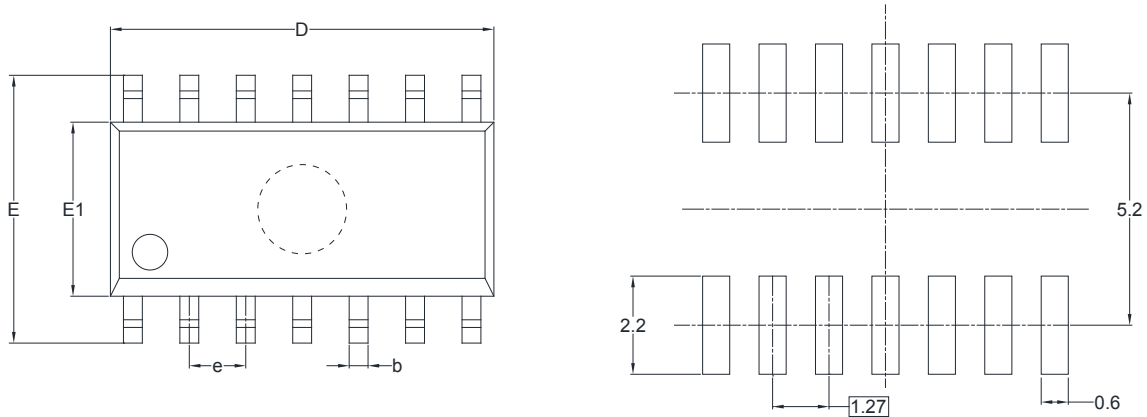

RECOMMENDED LAND PATTERN (Unit: mm)

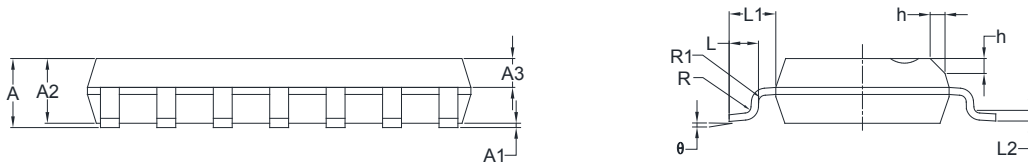

Symbol	Dimensions In Millimeters		Dimensions In Inches	
	MIN	MAX	MIN	MAX
A	1.35	1.75	0.053	0.069
A1	0.10	0.25	0.004	0.010
A2	1.25	1.65	0.049	0.065
A3	0.55	0.75	0.022	0.030
b	0.36	0.49	0.014	0.019
D	8.53	8.73	0.336	0.344
E	5.80	6.20	0.228	0.244
E1	3.80	4.00	0.150	0.157
e	1.27 BSC		0.050 BSC	
L	0.45	0.80	0.018	0.032
L1	1.04 REF		0.040 REF	
L2	0.25 BSC		0.01 BSC	
R	0.07		0.003	
R1	0.07		0.003	
h	0.30	0.50	0.012	0.020
θ	0°	8°	0°	8°

PACKAGE OUTLINE DIMENSIONS

TSSOP-14

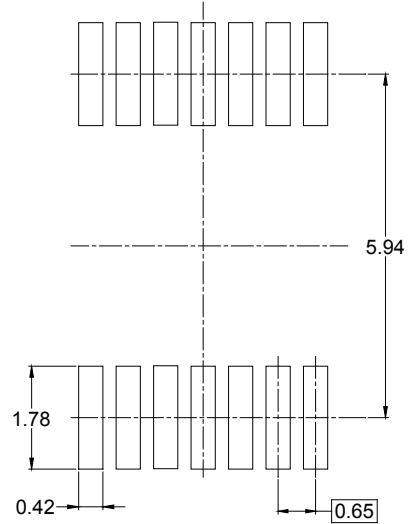
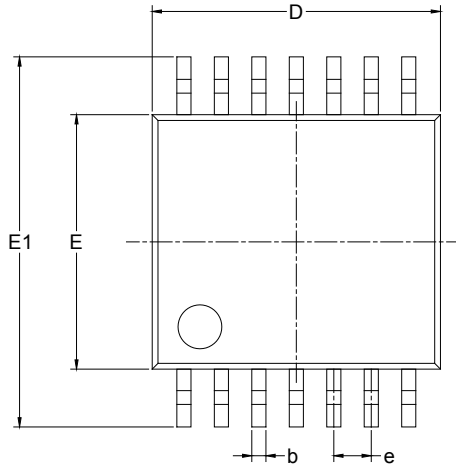

RECOMMENDED LAND PATTERN (Unit: mm)

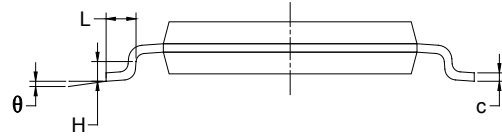
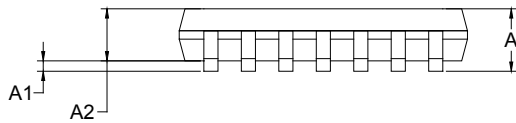

Symbol	Dimensions In Millimeters		Dimensions In Inches	
	MIN	MAX	MIN	MAX
A		1.200		0.047
A1	0.050	0.150	0.002	0.006
A2	0.800	1.050	0.031	0.041
b	0.190	0.300	0.007	0.012
c	0.090	0.200	0.004	0.008
D	4.860	5.100	0.191	0.201
E	4.300	4.500	0.169	0.177
E1	6.250	6.550	0.246	0.258
e	0.650 BSC		0.026 BSC	
L	0.500	0.700	0.02	0.028
H	0.25 TYP		0.01 TYP	
θ	1°	7°	1°	7°

PACKAGE INFORMATION

TAPE AND REEL INFORMATION

REEL DIMENSIONS

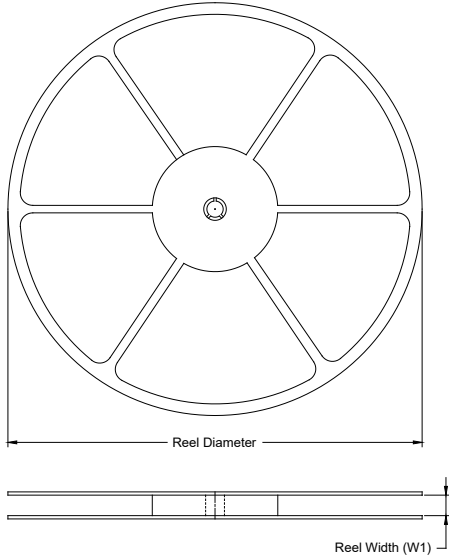

TAPE DIMENSIONS



NOTE: The picture is only for reference. Please make the object as the standard.

KEY PARAMETER LIST OF TAPE AND REEL

Package Type	Reel Diameter	Reel Width W1 (mm)	A0 (mm)	B0 (mm)	K0 (mm)	P0 (mm)	P1 (mm)	P2 (mm)	W (mm)	Pin1 Quadrant
SOT-23-5	7"	9.5	3.20	3.20	1.40	4.0	4.0	2.0	8.0	Q3
SC70-5	7"	9.5	2.25	2.55	1.20	4.0	4.0	2.0	8.0	Q3
SOT-23-6	7"	9.5	3.17	3.23	1.37	4.0	4.0	2.0	8.0	Q3
SOIC-8	13"	12.4	6.40	5.40	2.10	4.0	8.0	2.0	12.0	Q1
MSOP-8	13"	12.4	5.20	3.30	1.50	4.0	8.0	2.0	12.0	Q1
SOIC-14	13"	16.4	6.60	9.30	2.10	4.0	8.0	2.0	16.0	Q1
TSSOP-14	13"	12.4	6.95	5.60	1.20	4.0	8.0	2.0	12.0	Q1

D00001

PACKAGE INFORMATION

CARTON BOX DIMENSIONS



NOTE: The picture is only for reference. Please make the object as the standard.

KEY PARAMETER LIST OF CARTON BOX

Reel Type	Length (mm)	Width (mm)	Height (mm)	Pizza/Carton
7" (Option)	368	227	224	8
7"	442	410	224	18
13"	386	280	370	5

DD0002

单击下面可查看定价，库存，交付和生命周期等信息

[>>SGMICRO\(圣邦微电子\)](#)