

GENERAL DESCRIPTION

The SGM2578A is a single load switch with reverse current protection function. The device can operate from 1V to 5.5V single supply and has the ability to drive up to 2A continuous current.

The device contains a 30mΩ low R_{ON} N-MOSFET controlled by the ON pin. If the power supply is turned on for the first time, a smart pull-down resistor is used to float the ON pin until the system is stable. Once the ON pin reaches a high voltage (> V_{IH}), the pull-down resistor is disconnected, then the standby current is very low and power loss can be reduced. The small package and low R_{ON} make the device very suitable for space limited, battery powered applications.

The device supports a wide input voltage range, which is suitable for different voltage rails. The rise time is used to avoid inrush current. The SGM2578A offers the quick output discharge function in disable status.

The SGM2578A is available in a Green WLCSP-0.9×0.9-4B-A package.

FEATURES

- **Input Voltage Range: 1V to 5.5V**
- **Low On-Resistance**
 - ♦ R_{ON} = 29mΩ at V_{IN} = 4.35V
 - ♦ R_{ON} = 30mΩ at V_{IN} = 3.3V
 - ♦ R_{ON} = 36mΩ at V_{IN} = 1.0V
- **Low Shutdown Current: 90nA (TYP)**
- **Maximum Continuous Current: 2A**
- **Reverse Current Protection When Disabled**
- **Low Threshold 1.8V GPIO Control Input**
- **Bidirectional Power Supply for Power Zone Application**
- **Rise Time:**
 - ♦ SGM2578AAD: 200μs (TYP)
 - ♦ SGM2578ABD: 5000μs (TYP)
- **Quick Output Discharge**
- **Available in a Green WLCSP-0.9×0.9-4B-A Package**

APPLICATIONS

- Mobile Phone
- Ultrabook
- Tablet PC
- Digital Camera
- Wearable Technology
- Solid State Drive

TYPICAL APPLICATION

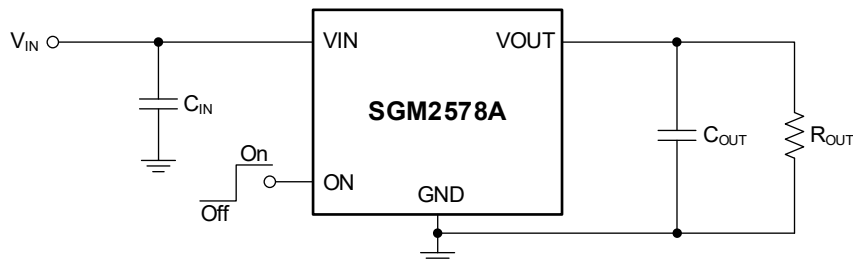

Figure 1. Typical Application Circuit

PACKAGE/ORDERING INFORMATION

MODEL	PACKAGE DESCRIPTION	SPECIFIED TEMPERATURE RANGE	ORDERING NUMBER	PACKAGE MARKING	PACKING OPTION
SGM2578AAD	WLCSP-0.9×0.9-4B-A	-40°C to +85°C	SGM2578AADYG/TR	J7 XX	Tape and Reel, 3000
SGM2578ABD	WLCSP-0.9×0.9-4B-A	-40°C to +85°C	SGM2578ABDYG/TR	J8 XX	Tape and Reel, 3000

MARKING INFORMATION

NOTE: XX = Date Code.

YY — Serial Number

XX

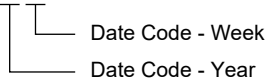

Green (RoHS & HSF): SG Micro Corp defines "Green" to mean Pb-Free (RoHS compatible) and free of halogen substances. If you have additional comments or questions, please contact your SGMICRO representative directly.

ABSOLUTE MAXIMUM RATINGS

- Input Voltage Range, V_{IN}..... -0.3V to 6V
- Output Voltage Range, V_{OUT}..... -0.3V to 6V
- ON Pin Voltage Range, V_{ON}..... -0.3V to 6V
- Maximum Continuous Switch Current, I_{MAX}..... 2A
- Maximum Pulsed Switch Current, Pulse < 300µs, 2% Duty Cycle, I_{PLS} 2.5A
- Junction Temperature +150°C
- Storage Temperature Range..... -65°C to +150°C
- Lead Temperature (Soldering, 10s) +260°C
- ESD Susceptibility
- HBM..... 4000V
- CDM 1000V

RECOMMENDED OPERATING CONDITIONS

- Input Voltage Range, V_{IN}..... 1V to 5.5V
- Output Voltage Range, V_{OUT}..... 0V to 5.5V
- ON Pin Input High Voltage, V_H..... 1.2V to 5.5V
- ON Pin Input Low Voltage, V_{IL} 0V to 0.4V
- Input Capacitance, C_{IN}..... 1µF
- Operating Ambient Temperature Range..... -40°C to +85°C
- Operating Junction Temperature Range -40°C to +125°C

OVERSTRESS CAUTION

Stresses beyond those listed in Absolute Maximum Ratings may cause permanent damage to the device. Exposure to absolute maximum rating conditions for extended periods may affect reliability. Functional operation of the device at any conditions beyond those indicated in the Recommended Operating Conditions section is not implied.

ESD SENSITIVITY CAUTION

This integrated circuit can be damaged if ESD protections are not considered carefully. SGMICRO recommends that all integrated circuits be handled with appropriate precautions. Failure to observe proper handling and installation procedures can cause damage. ESD damage can range from subtle performance degradation to complete device failure. Precision integrated circuits may be more susceptible to damage because even small parametric changes could cause the device not to meet the published specifications.

DISCLAIMER

SG Micro Corp reserves the right to make any change in circuit design, or specifications without prior notice.

PIN CONFIGURATION

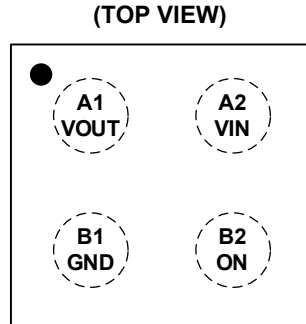

WLCSP-0.9×0.9-4B-A

PIN DESCRIPTION

PIN	NAME	DESCRIPTION
A1	VOUT	Switch Output.
A2	VIN	Switch Input. It is recommended to use a bypass capacitor (ceramic) to ground.
B1	GND	Ground.
B2	ON	Switch Control Input. Active high enables the device. Do not float this pin.

FUNCTIONAL BLOCK DIAGRAM

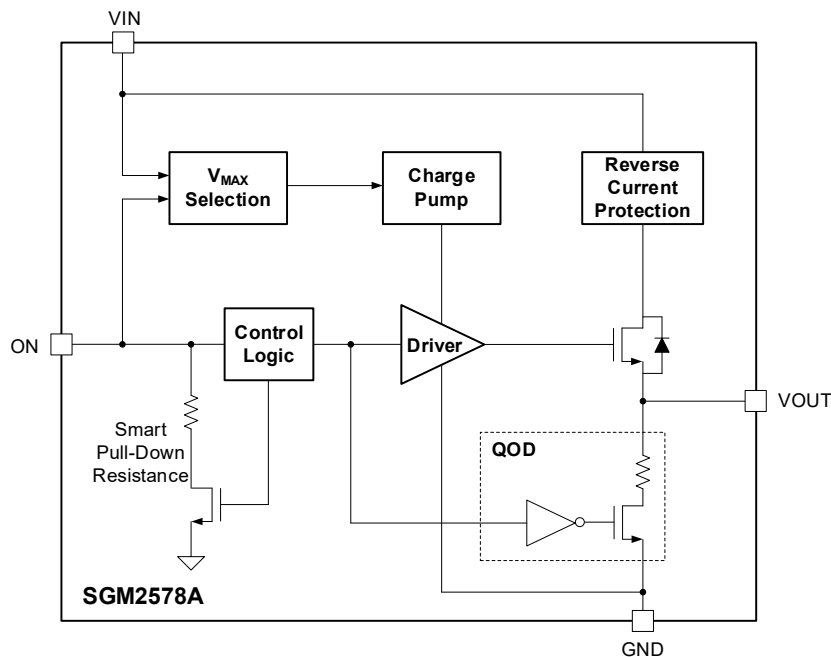

ELECTRICAL CHARACTERISTICS(T_J = -40°C to +85°C, V_{IN} = 1V to 5.5V, C_{IN} = 1μF, C_{OUT} = 0.1μF, typical values are at T_J = +25°C, unless otherwise noted.)

PARAMETER	SYMBOL	CONDITIONS	MIN	TYP	MAX	UNITS
Input Voltage Range	V _{IN}		1		5.5	V
Quiescent Current	I _Q	V _{IN} = 5.5V, V _{ON} = 1.2V, I _{OUT} = 0mA		320	950	nA
		V _{IN} = 3.3V, V _{ON} = 1.2V, I _{OUT} = 0mA		220	650	
		V _{IN} = 1V, V _{ON} = 1.2V, I _{OUT} = 0mA		150	500	
Shutdown Current	I _{SD}	V _{IN} = 5.5V, V _{ON} = 0V		90	650	nA
Supply Leakage Current in Shutdown Mode	I _{LEAKAGE}	V _{IN} = 5.5V, V _{ON} = 0V, V _{OUT} = 0V			660	nA
On-Resistance	R _{ON}	V _{IN} = 4.35V, V _{ON} = 1.2V, I _{OUT} = -200mA		29	50	mΩ
		V _{IN} = 3.3V, V _{ON} = 1.2V, I _{OUT} = -200mA		30	50	
		V _{IN} = 1.0V, V _{ON} = 1.2V, I _{OUT} = -200mA		36	57	
ON Pin Hysteresis	V _{HYS}	V _{IN} = 5.5V		34		mV
		V _{IN} = 3.3V		30		
ON Pin Leakage Current	I _{ON}	V _{ON} = 5.5V			670	nA
Reverse Current When Disabled	I _{RC}	V _{IN} = V _{ON} = 0V, V _{OUT} = 5.5V			1	μA
Output Pull-Down Resistance	R _{PD}	V _{IN} = 3.3V, V _{ON} = 0V, I _{OUT} = 2mA		280	400	Ω
Smart Pull-Down Resistance	R _{PD_ON}	Disabled, V _{IN} = 3.3V		1200		kΩ
ON Pin Input Low Voltage	V _{IL}				0.4	V
ON Pin Input High Voltage	V _{IH}		1.2			V

SWITCHING CHARACTERISTICS

(T_J = -40°C to +85°C, V_{IN} = 3.3V, R_{OUT} = 10Ω, C_{IN} = 1μF, C_{OUT} = 0.1μF, typical values are at T_J = +25°C, unless otherwise noted.)

PARAMETER	SYMBOL	CONDITIONS	MIN	TYP	MAX	UNITS
SGM2578AAD						
Turn-On Time	t _{ON}	V _{IH} = 1.2V, V _{IL} = 0V, Figure 2 and Figure 3		180		μs
Turn-Off Time	t _{OFF}			20		
VOUT Rise Time	t _R			200	450	
VOUT Fall Time	t _F			3		
Delay Time	t _D			130		
SGM2578ABD						
Turn-On Time	t _{ON}	V _{IH} = 1.2V, V _{IL} = 0V, Figure 2 and Figure 3		5000		μs
Turn-Off Time	t _{OFF}			20		
VOUT Rise Time	t _R			5000		
VOUT Fall Time	t _F			3		
Delay Time	t _D			2700		

PARAMETER MEASUREMENT INFORMATION

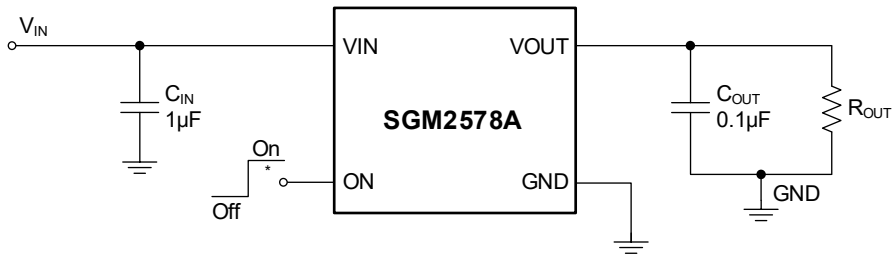

*: Rise and fall times of the control signal are 100ns.

Figure 2. Test Circuit

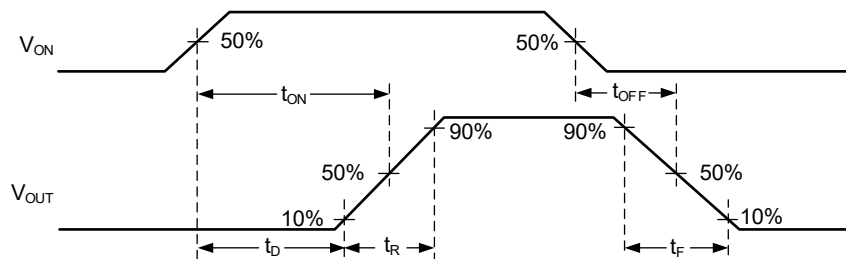
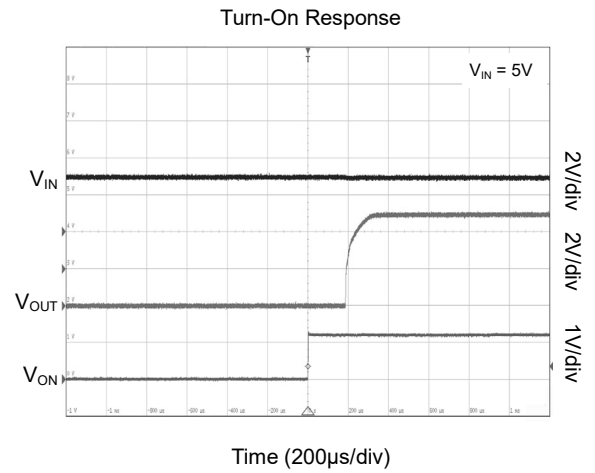
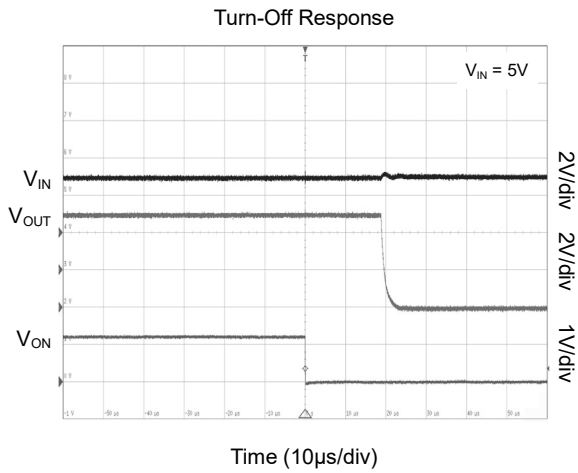
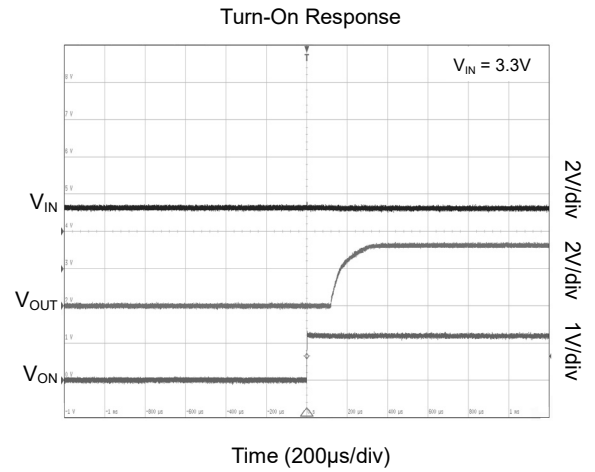
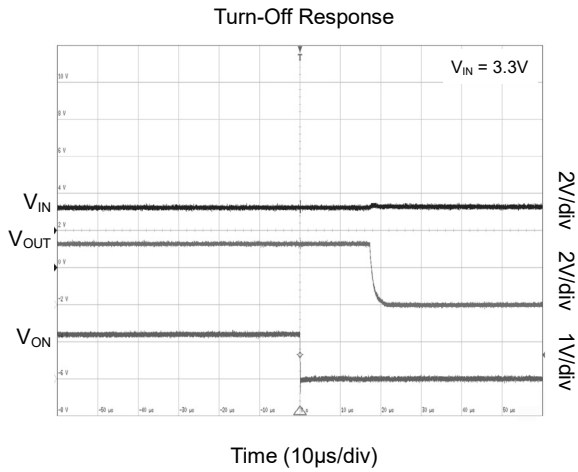
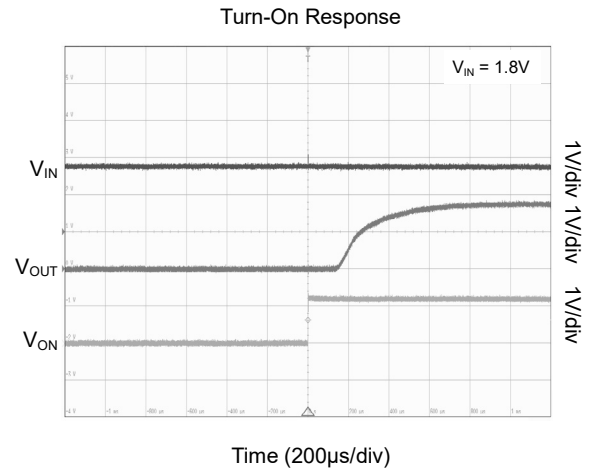
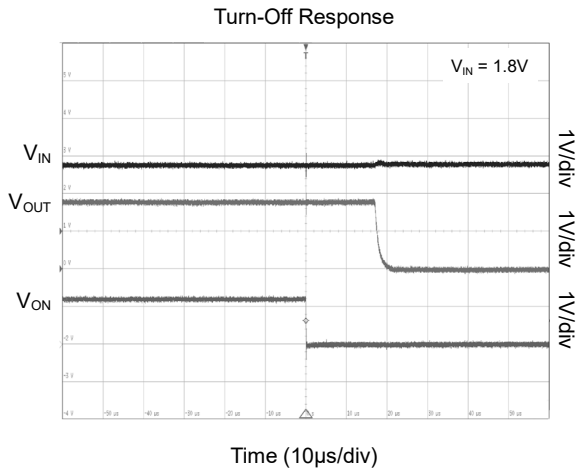

Figure 3. Timing Waveforms

TYPICAL PERFORMANCE CHARACTERISTICS

T_J = +25°C, C_{IN} = 1μF, C_{OUT} = 0.1μF, R_{OUT} = 10Ω, V_{IH} = 1.2V, V_{IL} = 0V, unless otherwise noted.



TYPICAL PERFORMANCE CHARACTERISTICS (continued)

T_J = +25°C, C_{IN} = 1μF, C_{OUT} = 0.1μF, R_{OUT} = 10Ω, V_{IH} = 1.2V, V_{IL} = 0V, unless otherwise noted.

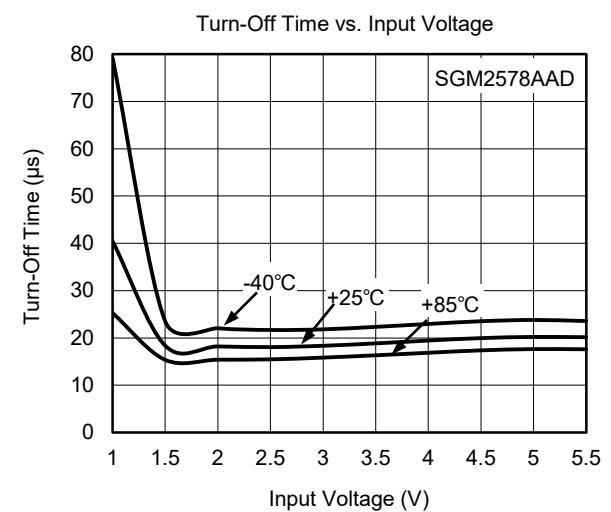
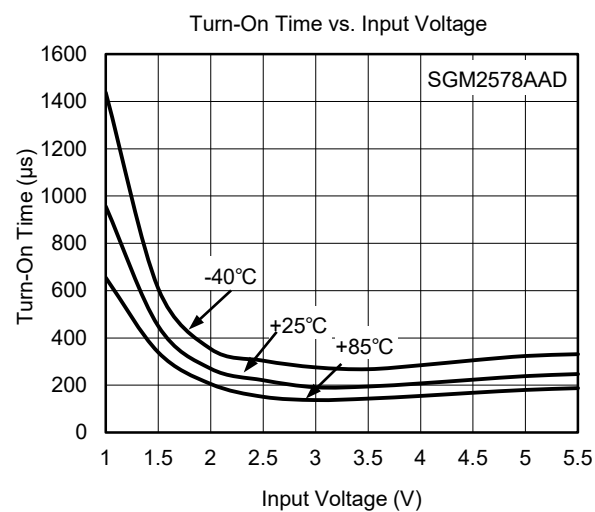
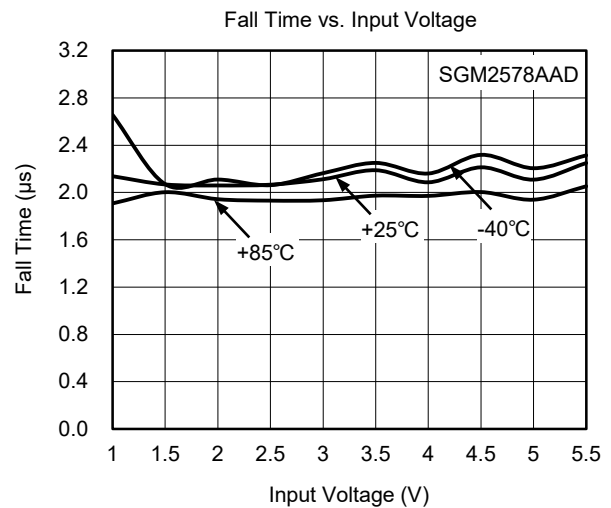
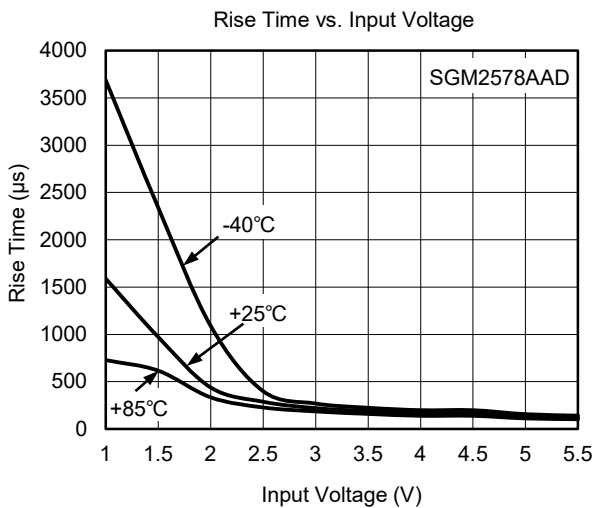
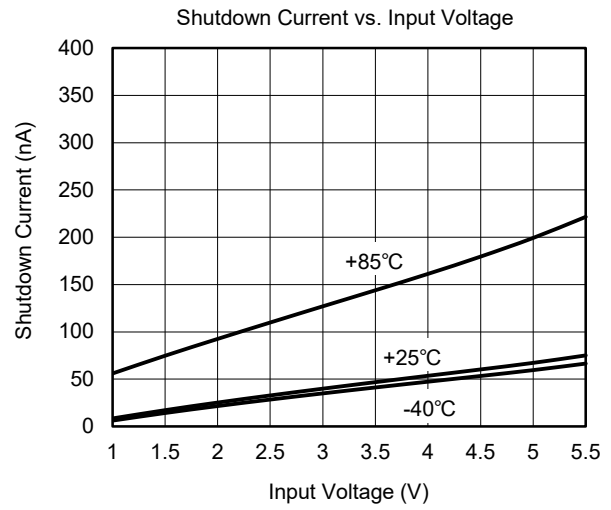
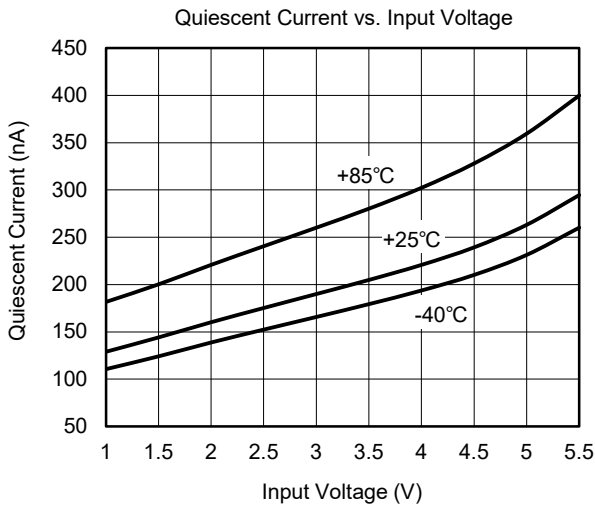

TYPICAL PERFORMANCE CHARACTERISTICS (continued)

T_J = +25°C, C_{IN} = 1μF, C_{OUT} = 0.1μF, R_{OUT} = 10Ω, V_{IH} = 1.2V, V_{IL} = 0V, unless otherwise noted.

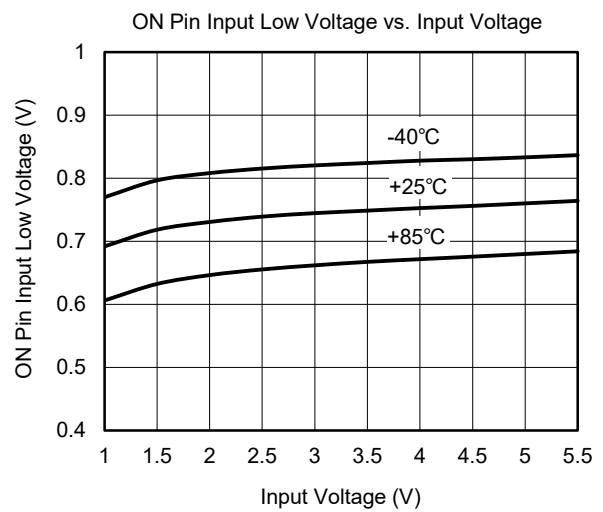
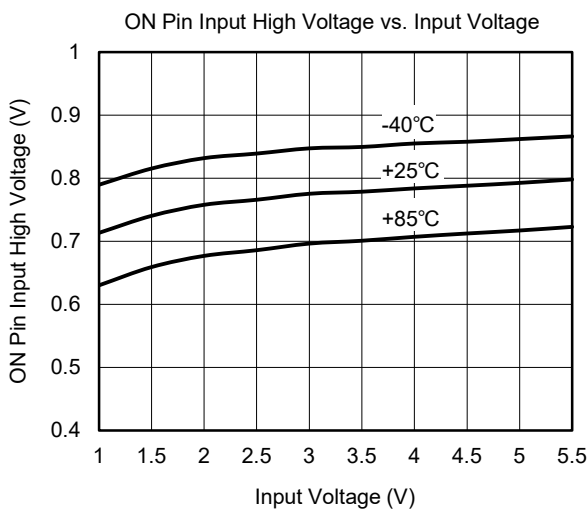
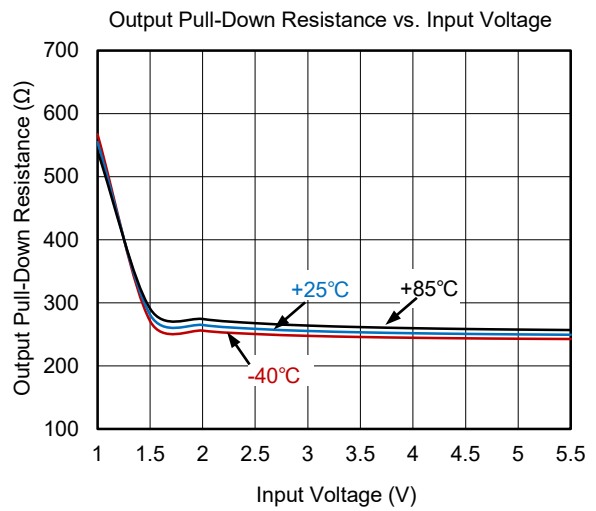
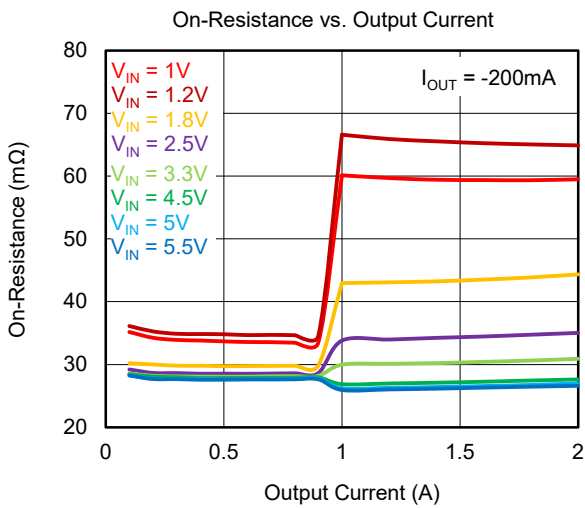
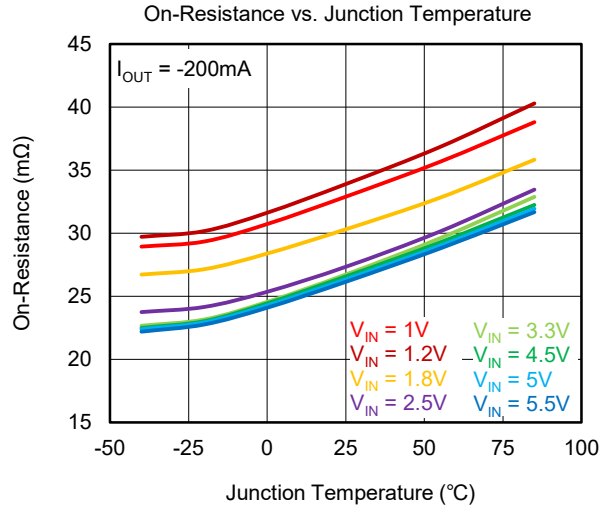
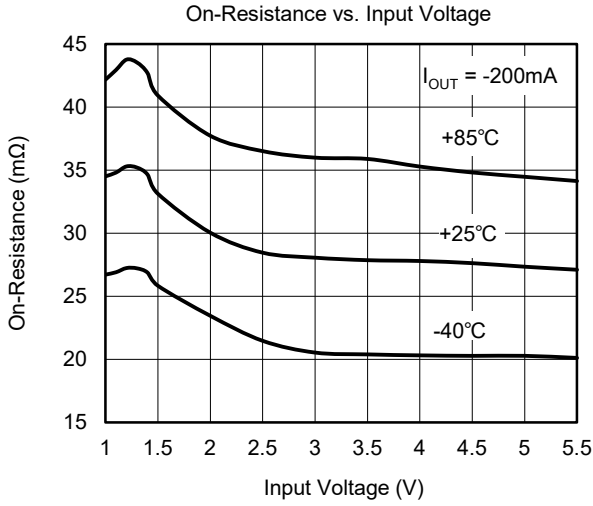

TYPICAL PERFORMANCE CHARACTERISTICS (continued)

T_J = +25°C, C_{IN} = 1μF, C_{OUT} = 0.1μF, R_{OUT} = 10Ω, V_{IH} = 1.2V, V_{IL} = 0V, unless otherwise noted.

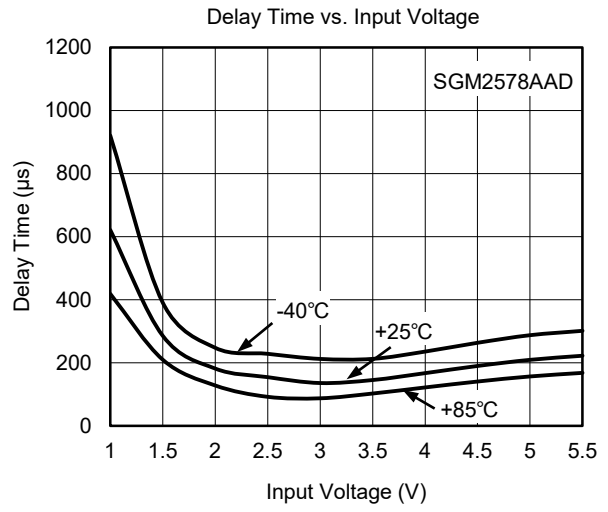
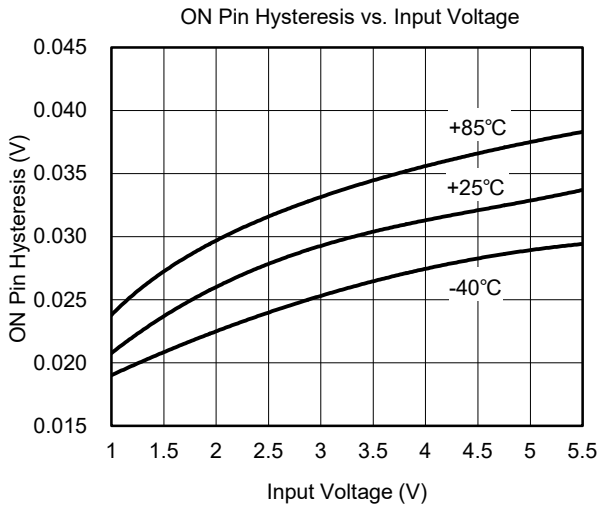

DETAILED DESCRIPTION

The SGM2578A is a single, 4-ball, 2A load switch. A low on-resistance N-MOSFET is integrated, which makes a low voltage drop across the device. To choose suitable rise time is always used to avoid inrush current.

Control Pin

The ON pin can control the device. Pulling the ON pin high enables the device. Logic high of V_{IH} (ON pin) will enable the device and V_{IL} will turn off it. It has the ability to interface with low-voltage GPIO. It can support with 1.8V, 2.5V, 3.3V GPIOs.

Quick Output Discharge (QOD)

The quick output discharge feature is available for SGM2578A. If the ON pin is pulled low, a discharge resistor of 280Ω (TYP) is connected between VOUT and GND pins to prevent the output from floating when the switch is disabled.

Functional Modes

The connection of the VOUT pin is shown in Table 1. Table 2 shows the smart-ON functions.

Table 1. VOUT Connection

ON Pin	VOUT Pin
L	GND
H	VIN

Table 2. Smart-ON Functional Modes

ON	ON Pin
Below V _{IL}	Pull-Down Active
Above V _{IH}	No Pull-Down

APPLICATION INFORMATION

SGM2578A is a single, up to 2A current capability load switch with low on-resistance. It has a wide input range, which can be used in different end equipment to set power sequence, reduce inrush current and maintain low standby leakage current. The typical application circuit of SGM2578A is shown in Figure 4.

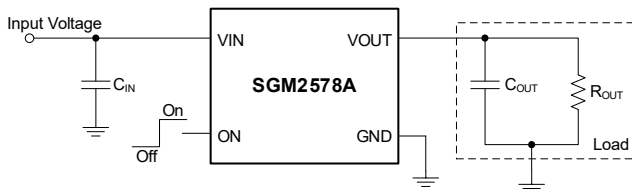

Figure 4. Typical Application Circuit

Input Capacitor

A 1μF input capacitor (C_{IN}) is recommended to use between VIN and GND close to the device pins. It can limit the voltage drop on the input supply. Larger C_{IN} can reduce voltage dip in high current applications.

Output Capacitor

A 0.1μF output capacitor (C_{OUT}) should be placed between VOUT and GND as close to the device pins as possible. This capacitor will prevent parasitic board inductances from forcing V_{OUT} below GND when the switch is shutdown. To improve the V_{IN} drooping when the device is turned on, it is recommended that C_{IN} is placed greater than C_{OUT}, due to the C_{IN} is charge for C_{OUT}.

APPLICATION INFORMATION (continued)

Reverse Current Protection

If the ON pin is pulled low, the device is disabled, while $V_{IN} > 1V$ or $V_{OUT} > 1V$ is met, the reverse current protection function is activated. This function prevents the current flowing from VOUT to VIN, and is very useful when SGM2578A is disabled and the output needs to be driven by another voltage source.

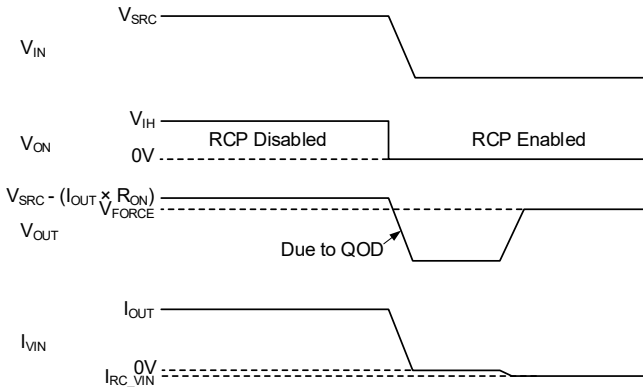

NOTES: V_{SRC} is the input power supply to the equipment. V_{FORCE} is the external power source forced at VOUT pin. I_{VIN} is the current of VIN pin. I_{OUT} is output load current.

Figure 5. Reverse Current Protection

Figure 5 shows how the reverse current protection circuit is activated in SGM2578A. Pulling the ON pin down, the device is shut down and an external voltage (V_{FORCE}) is forced to VOUT pin, the reverse current is tested very small given by I_{RC_VIN}. This will prevent any large extra current reverse from the V_{FORCE} (added on V_{OUT}) to V_{IN}.

Power Supply Recommendations

The SGM2578A is designed for a wide operate input voltage range of 1V to 5.5V. Place a 1μF input bypass capacitor close to the device pins is recommended.

Power Supply Sequencing without a GPIO Input

In many terminal devices, each module needs to be powered up in a pre-determined manner. SGM2578A can set a power sequence by the t_{DELAY} without extra GPIO, and may reduce inrush current. Figure 6 shows the sequence that the ON pin of first load switch is connected to the VIN, and the second load switch ON pin is connected to the VOUT of first load switch. The second load switch is powered up when the first load switch is turned on, this is the fixed sequence and the delay time set by default t_{DELAY}.

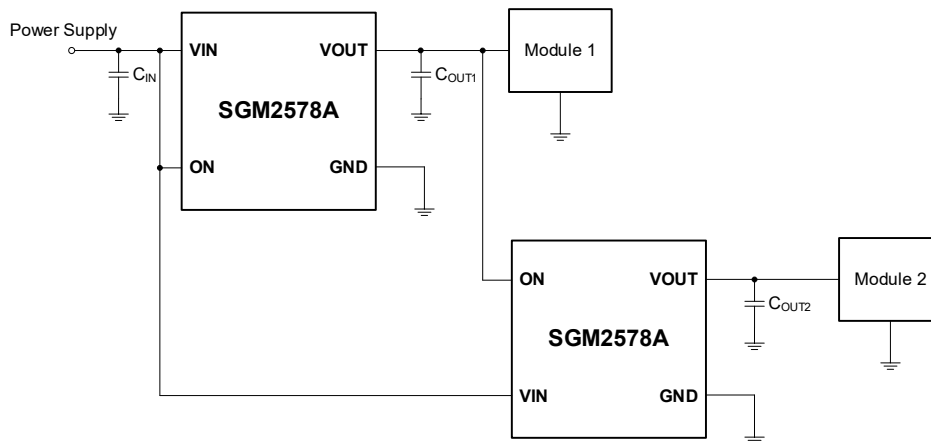

Figure 6. Power Supply Sequencing without a GPIO Input

REVISION HISTORY

NOTE: Page numbers for previous revisions may differ from page numbers in the current version.

MARCH 2023 – REV.A.1 to REV.A.2	Page
Updated Functional Block Diagram section.....	3

JANUARY 2022 – REV.A to REV.A.1	Page
Updated Package Outline Dimensions section	12

Changes from Original (JUNE 2020) to REV.A	Page
Changed from product preview to production data.....	All

PACKAGE INFORMATION

PACKAGE OUTLINE DIMENSIONS

WLCSP-0.9×0.9-4B-A

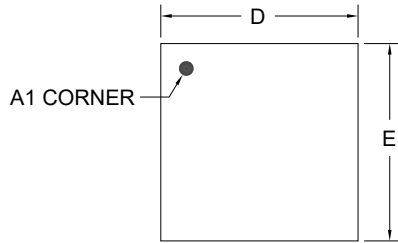

TOP VIEW

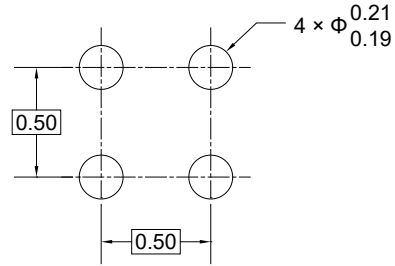

RECOMMENDED LAND PATTERN (Unit: mm)

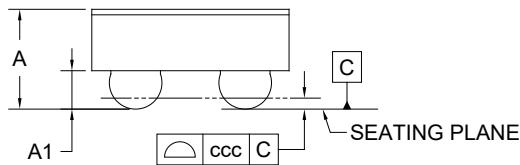

SIDE VIEW

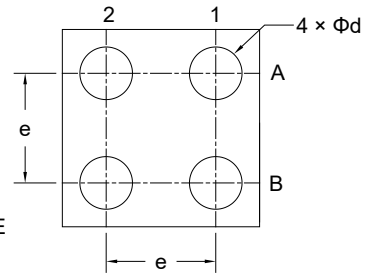

BOTTOM VIEW

Symbol	Dimensions In Millimeters		
	MIN	MOD	MAX
A	-	-	0.493
A1	0.155	-	0.195
D	0.870	-	0.930
E	0.870	-	0.930
d	0.210	-	0.270
e	0.500 BSC		
ccc	0.050		

NOTE: This drawing is subject to change without notice.

PACKAGE INFORMATION

TAPE AND REEL INFORMATION

REEL DIMENSIONS



TAPE DIMENSIONS



NOTE: The picture is only for reference. Please make the object as the standard.

KEY PARAMETER LIST OF TAPE AND REEL

Package Type	Reel Diameter	Reel Width W1 (mm)	A0 (mm)	B0 (mm)	K0 (mm)	P0 (mm)	P1 (mm)	P2 (mm)	W (mm)	Pin1 Quadrant
WLCSP-0.9×0.9-4B-A	7"	9.2	1.02	1.02	0.62	4.0	4.0	2.0	8.0	Q1

000001

PACKAGE INFORMATION

CARTON BOX DIMENSIONS



NOTE: The picture is only for reference. Please make the object as the standard.

KEY PARAMETER LIST OF CARTON BOX

Reel Type	Length (mm)	Width (mm)	Height (mm)	Pizza/Carton
7" (Option)	368	227	224	8
7"	442	410	224	18

DD0002

单击下面可查看定价，库存，交付和生命周期等信息

[>>SGMICRO\(圣邦微电子\)](#)