

### GENERAL DESCRIPTION

The SGM2231 is a low power, low noise, fast transient response and low dropout voltage linear regulator. It provides -500mA output current capability. The operating input voltage range is from -2.7V to -24V. The adjustable output voltage range is from -1.1V to  $(-V_{IN} + V_{DROPO})$ .

Other features include logic-controlled shutdown mode, short-circuit current limit and thermal shutdown protection. The SGM2231 has automatic discharge function to quickly discharge  $V_{OUT}$  in the disabled status.

The SGM2231 is available in a Green UTDFN-2x2-8CL package. It operates over an operating temperature range of -40°C to +125°C.

### APPLICATIONS

Industrial and Medical Equipment  
 Communications and Infrastructure  
 Precision Amplifiers  
 ADC and DAC Circuits

### FEATURES

- **Input Voltage Range: -2.7V to -24V**
- **Fixed Outputs of -1.1V, -1.2V, -1.5V, -1.8V, -2.5V, -2.8V, -3.0V, -3.3V and -5.0V**
- **Adjustable Output from -1.1V to  $(-V_{IN} + V_{DROPO})$**
- **Output Voltage Accuracy:  $\pm 1\%$  at +25°C**
- **-500mA Output Current**
- **Low Quiescent Current:**  
 $I_{GND} = -47\mu A$  (TYP) at No Load
- **Low Dropout Voltage:**  
 $-230mV$  (TYP) at -500mA,  $V_{OUT} = -5.0V$
- **Low Noise:  $10\mu V_{RMS}$  (TYP) at  $V_{OUT} = -1.1V$**
- **Low Shutdown Current:  $-1.2\mu A$  (TYP)**
- **PSRR: -65dB (TYP) at 10kHz,  $V_{OUT} = -1.1V$**
- **Current Limiting and Thermal Protection**
- **Positive or Negative Enable Logic**
- **Stable with Small Case Size Ceramic Capacitors**
- **-40°C to +125°C Operating Temperature Range**
- **Available in a Green UTDFN-2x2-8CL Package**

### TYPICAL APPLICATION

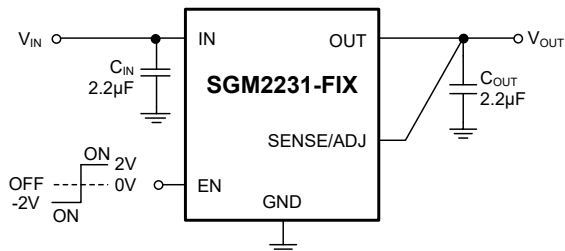

Fixed Output Voltage Version

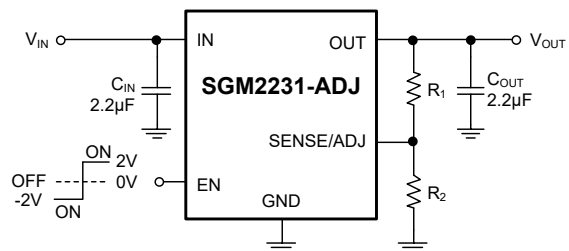

Adjustable Output Voltage Version

Figure 1. Typical Application Circuits

**PACKAGE/ORDERING INFORMATION**

| MODEL       | PACKAGE DESCRIPTION | SPECIFIED TEMPERATURE RANGE | ORDERING NUMBER      | PACKAGE MARKING | PACKING OPTION      |
|-------------|---------------------|-----------------------------|----------------------|-----------------|---------------------|
| SGM2231-1.1 | UTDFN-2x2-8CL       | -40°C to +125°C             | SGM2231-1.1XUGN8G/TR | 07D<br>XXXX     | Tape and Reel, 3000 |
| SGM2231-1.2 | UTDFN-2x2-8CL       | -40°C to +125°C             | SGM2231-1.2XUGN8G/TR | 0X0<br>XXXX     | Tape and Reel, 3000 |
| SGM2231-1.5 | UTDFN-2x2-8CL       | -40°C to +125°C             | SGM2231-1.5XUGN8G/TR | 0X1<br>XXXX     | Tape and Reel, 3000 |
| SGM2231-1.8 | UTDFN-2x2-8CL       | -40°C to +125°C             | SGM2231-1.8XUGN8G/TR | 0X2<br>XXXX     | Tape and Reel, 3000 |
| SGM2231-2.5 | UTDFN-2x2-8CL       | -40°C to +125°C             | SGM2231-2.5XUGN8G/TR | 00Y<br>XXXX     | Tape and Reel, 3000 |
| SGM2231-2.8 | UTDFN-2x2-8CL       | -40°C to +125°C             | SGM2231-2.8XUGN8G/TR | 0X3<br>XXXX     | Tape and Reel, 3000 |
| SGM2231-3.0 | UTDFN-2x2-8CL       | -40°C to +125°C             | SGM2231-3.0XUGN8G/TR | 00Z<br>XXXX     | Tape and Reel, 3000 |
| SGM2231-3.3 | UTDFN-2x2-8CL       | -40°C to +125°C             | SGM2231-3.3XUGN8G/TR | 111<br>XXXX     | Tape and Reel, 3000 |
| SGM2231-5.0 | UTDFN-2x2-8CL       | -40°C to +125°C             | SGM2231-5.0XUGN8G/TR | 0P0<br>XXXX     | Tape and Reel, 3000 |
| SGM2231-ADJ | UTDFN-2x2-8CL       | -40°C to +125°C             | SGM2231-ADJXUGN8G/TR | 05L<br>XXXX     | Tape and Reel, 3000 |

**MARKING INFORMATION**

NOTE: XXXX = Date Code, Trace Code and Vendor Code.

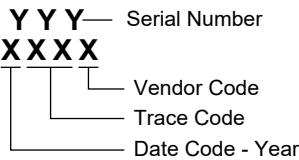

Green (RoHS & HSF): SG Micro Corp defines "Green" to mean Pb-Free (RoHS compatible) and free of halogen substances. If you have additional comments or questions, please contact your SGMICRO representative directly.

**ABSOLUTE MAXIMUM RATINGS**

|   |                                   |
|---|-----------------------------------|
| IN to GND .....                           | +0.3V to -25V                     |
| OUT to GND .....                          | +0.3V to (V <sub>IN</sub> - 0.3V) |
| EN to GND.....                            | +5V to (V <sub>IN</sub> - 0.3V)   |
| EN to IN .....                            | +25V to -0.3V                     |
| SENSE/ADJ to GND .....                    | +0.3V to V <sub>OUT</sub>         |
| Package Thermal Resistance                |                                   |
| UTDFN-2×2-8CL, θ <sub>JA</sub> .....      | 82°C/W                            |
| UTDFN-2×2-8CL, θ <sub>JB</sub> .....      | 45°C/W                            |
| UTDFN-2×2-8CL, θ <sub>JC(TOP)</sub> ..... | 52°C/W                            |
| UTDFN-2×2-8CL, θ <sub>JC(BOT)</sub> ..... | 13.7°C/W                          |
| Junction Temperature.....                 | +150°C                            |
| Storage Temperature Range .....           | -65°C to +150°C                   |
| Lead Temperature (Soldering, 10s).....    | +260°C                            |
| ESD Susceptibility                        |                                   |
| HBM.....                                  | 8000V                             |
| CDM .....                                 | 1000V                             |

**RECOMMENDED OPERATING CONDITIONS**

|  |                 |
|--|-----------------|
| Input Voltage Range .....                            | -2.7V to -24V   |
| Input Effective Capacitance, C <sub>IN</sub> .....   | 1.5µF (MIN)     |
| Output Effective Capacitance, C <sub>OUT</sub> ..... | 1.5µF to 10µF   |
| Operating Junction Temperature Range .....           | -40°C to +125°C |

**OVERSTRESS CAUTION**

Stresses beyond those listed in Absolute Maximum Ratings may cause permanent damage to the device. Exposure to absolute maximum rating conditions for extended periods may affect reliability. Functional operation of the device at any conditions beyond those indicated in the Recommended Operating Conditions section is not implied.

**ESD SENSITIVITY CAUTION**

This integrated circuit can be damaged if ESD protections are not considered carefully. SGMICRO recommends that all integrated circuits be handled with appropriate precautions. Failure to observe proper handling and installation procedures can cause damage. ESD damage can range from subtle performance degradation to complete device failure. Precision integrated circuits may be more susceptible to damage because even small parametric changes could cause the device not to meet the published specifications.

**DISCLAIMER**

SG Micro Corp reserves the right to make any change in circuit design, or specifications without prior notice.

PIN CONFIGURATION

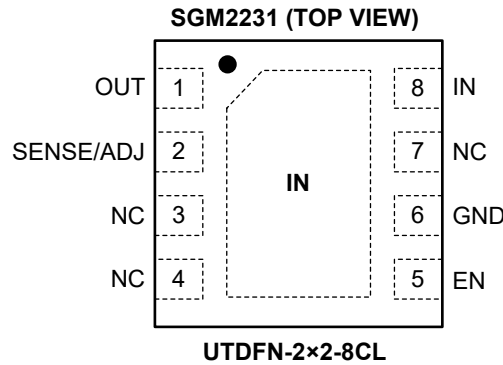

PIN DESCRIPTION

| PIN         | NAME      | FUNCTION  |
|-------------|-----------|---|
| 1           | OUT       | Regulator Output Pin. It is recommended to use a ceramic capacitor with effective capacitance in the range of 1.5μF to 10μF to ensure stability. This ceramic capacitor should be placed as close as possible to the OUT pin.   |
| 2           | SENSE/ADJ | Sense or Adjust Input Pin. For fixed output voltage version, this pin is connected to load or the OUT pin directly. For adjustable output voltage version, this pin is connected to the midpoint of an external resistor divider to set the output voltage lower than the fixed output voltage (-1.1V). |
| 3, 4, 7     | NC        | Not Connected.  |
| 5           | EN        | Enable Pin. Drive EN 2.0V above or below ground to turn on the regulator. Drive EN to ground to turn off the regulator. Connect the EN pin to the IN pin when using automatic startup.  |
| 6           | GND       | Ground.   |
| 8           | IN        | Input Voltage Supply Pin. It is recommended to use a 2.2μF or larger ceramic capacitor from the IN pin to ground to get good power supply decoupling. This ceramic capacitor should be placed as close as possible to the IN pin.   |
| Exposed Pad | IN        | Exposed Pad. Connect the exposed pad at the bottom of the package to the internal IN for maximum thermal performance. In normal use, connect the exposed pad to the IN on the board, which is the most negative potential in the negative voltage regulating circuit.                                   |

FUNCTIONAL BLOCK DIAGRAM

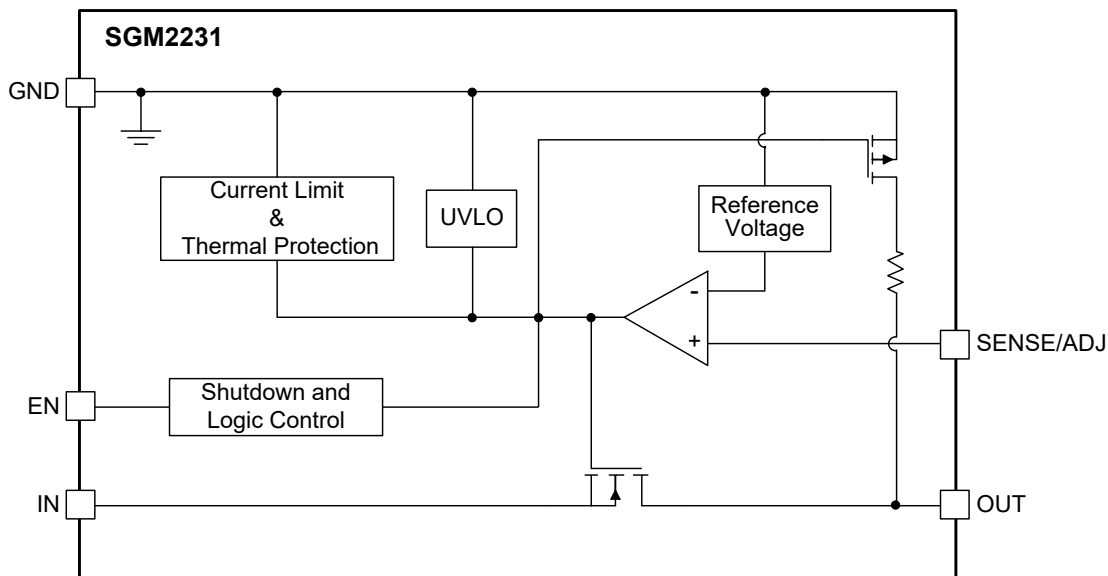

Figure 2. Internal Block Diagram

**ELECTRICAL CHARACTERISTICS**

( $V_{IN} = (V_{OUT(NOM)} - 0.5V)$  or  $-2.7V$  (whichever is greater),  $V_{EN} = V_{IN}$ ,  $I_{OUT} = -10mA$ ,  $C_{IN} = 2.2\mu F$  and  $C_{OUT} = 2.2\mu F$ .  $T_J = -40^\circ C$  to  $+125^\circ C$ , typical values are at  $T_J = +25^\circ C$ , unless otherwise noted.)

| PARAMETER                           | SYMBOL  | CONDITIONS  | MIN                    | TYP   | MAX    | UNITS         |    |
|-------------------------------------|---|---|------------------------|-------|--------|---------------|----|
| Input Voltage Range                 | $V_{IN}$  | $I_{OUT} = -250mA, T_J = +25^\circ C$   | -2.7                   |       | -24    | V             |    |
|                                     |   | $I_{OUT} = -350mA, T_J = +25^\circ C$   | -3.0                   |       | -24    | V             |    |
|                                     |   | $I_{OUT} = -500mA, T_J = +25^\circ C$   | -3.3                   |       | -24    | V             |    |
| Under-Voltage Lockout Thresholds    | $V_{UVLO}$  | $V_{IN}$ falling  |                        | -2.42 | -2.50  | V             |    |
|                                     |   | $V_{IN}$ rising   | -2.24                  | -2.33 |        | V             |    |
| Output Voltage Accuracy             | $V_{OUT}$   | $I_{OUT} = -10mA, T_J = +25^\circ C$  | -1                     |       | 1      | %             |    |
|                                     |   | $V_{IN} = (V_{OUT(NOM)} - 0.5V)$ to $-24V$ ,<br>$I_{OUT} = -1mA$ to $-500mA, T_J = -40^\circ C$ to $+125^\circ C$ | -1.5                   |       | 1.5    | %             |    |
| Feedback Voltage                    | $V_{ADJ}$   | $I_{OUT} = -10mA, T_J = +25^\circ C$  | -1.089                 | -1.1  | -1.111 | V             |    |
|                                     |   | $V_{IN} = (V_{OUT(NOM)} - 0.5V)$ to $-24V$ ,<br>$I_{OUT} = -1mA$ to $-500mA, T_J = -40^\circ C$ to $+125^\circ C$ | -1.083                 |       | -1.117 | V             |    |
| ADJ Pin Input Bias Current          | $I_{ADJ}$   | $V_{IN} = -2.7V$ to $-24V, V_{ADJ} = -1.3V$   | -3.5                   |       | 3.5    | nA            |    |
| Line Regulation                     | $\frac{\Delta V_{OUT}}{\Delta V_{IN} \times V_{OUT}}$ | $V_{IN} = (V_{OUT(NOM)} - 0.5V)$ to $-24V$  |                        | 0.002 | 0.03   | %/V           |    |
| Load Regulation                     | $\frac{\Delta V_{OUT}}{V_{OUT}}$                      | $I_{OUT} = -1mA$ to $-500mA$  |                        | 0.03  | 0.8    | %             |    |
| Dropout Voltage <sup>(1)</sup>      | $V_{DROP}$  | $I_{OUT} = -250mA$  | $V_{OUT(NOM)} = -2.5V$ |       | -200   | -350          | mV |
|                                     |   |   | $V_{OUT(NOM)} = -3.0V$ |       | -140   | -260          |    |
|                                     |   |   | $V_{OUT(NOM)} = -5.0V$ |       | -110   | -220          |    |
|                                     |   | $I_{OUT} = -350mA$  | $V_{OUT(NOM)} = -3.0V$ |       | -210   | -370          |    |
|                                     |   |   | $V_{OUT(NOM)} = -5.0V$ |       | -160   | -300          |    |
|                                     |   | $I_{OUT} = -500mA$  | $V_{OUT(NOM)} = -3.0V$ |       | -310   | -550          |    |
| $V_{OUT(NOM)} = -5.0V$              |   |   | -230                   | -420  |        |               |    |
| Output Current Limit <sup>(2)</sup> | $I_{LIMIT}$   | $V_{IN} = \text{MIN}(V_{OUT(NOM)} - 1V, -4V)$   | -0.52                  | -1.2  |        | A             |    |
| Short-Circuit Current               | $I_{SHORT}$   | $V_{IN} = -5.5V, V_{OUT} = 0V$  |                        | -410  |        | mA            |    |
| Operating Supply Current            | $I_{GND}$   | $I_{OUT} = 0\mu A$  |                        | -47   | -83    | $\mu A$       |    |
|                                     |   | $I_{OUT} = -500mA$  |                        | -1.4  | -2.1   | mA            |    |
| Shutdown Current                    | $I_{SHDN}$  | $V_{EN} = GND$  |                        | -1.2  | -3.0   | $\mu A$       |    |
|                                     |   | $V_{IN} = -24V, V_{EN} = GND$   |                        | -1.4  | -10    | $\mu A$       |    |
| Positive Enable High-Level Voltage  | $V_{EN(+HI)}$   |   | 1.22                   |       |        | V             |    |
| Positive Enable Low-Level Voltage   | $V_{EN(+LO)}$   |   |                        |       | 0.3    | V             |    |
| Negative Enable High-Level Voltage  | $V_{EN(-HI)}$   |   |                        |       | -2.0   | V             |    |
| Negative Enable Low-Level Voltage   | $V_{EN(-LO)}$   |   | -0.55                  |       |        | V             |    |
| EN Positive Input Current           | $I_{EN\_P}$   | $V_{IN} = -19V, V_{EN} = 5V$  |                        | 1     | 3      | $\mu A$       |    |
| EN Negative Input Current           | $I_{EN\_N}$   | $V_{IN} = -24V, V_{EN} = -24V$  |                        | -0.1  | -1     | $\mu A$       |    |
| Start-Up Time                       | $t_{STR}$   | From assertion of $V_{EN}$ to $V_{OUT} = 90\% \times V_{OUT(NOM)}$ ,<br>$V_{OUT} = -1.1V$                         |                        | 210   |        | $\mu s$       |    |
| Power Supply Rejection Ratio        | PSRR  | $V_{IN} = -2.7V, V_{OUT} = -1.1V$ ,<br>$\Delta V_{RIPPLE} = 0.2V_{P-P}$   | $f = 1kHz$             |       | -75    | dB            |    |
|                                     |   |   | $f = 10kHz$            |       | -65    |               |    |
|                                     |   |   | $f = 100kHz$           |       | -54    |               |    |
| Output Voltage Noise                | $e_n$   | $V_{OUT} = -1.1V, f = 10Hz$ to $100kHz$   |                        | 10    |        | $\mu V_{RMS}$ |    |
| Thermal Shutdown Temperature        | $T_{SHDN}$  |   |                        | 160   |        | $^\circ C$    |    |
| Thermal Shutdown Hysteresis         | $\Delta T_{SHDN}$                                     |   |                        | 20    |        | $^\circ C$    |    |

NOTES:

1. The dropout voltage is defined as the difference between  $V_{IN}$  and  $V_{OUT}$  when  $V_{OUT}$  falls to  $95\% \times V_{OUT(NOM)}$ .
2. Output current limit has the function of current foldback protection and refers to the current at which  $V_{OUT}$  falls to  $90\% \times V_{OUT(NOM)}$ .

**TYPICAL PERFORMANCE CHARACTERISTICS**

$T_J = +25^\circ\text{C}$ ,  $V_{IN} = (V_{OUT(NOM)} - 0.5\text{V})$  or  $-2.7\text{V}$  (whichever is greater),  $V_{EN} = V_{IN}$ ,  $I_{OUT} = -10\text{mA}$ ,  $C_{IN} = 2.2\mu\text{F}$  and  $C_{OUT} = 2.2\mu\text{F}$ , unless otherwise noted.

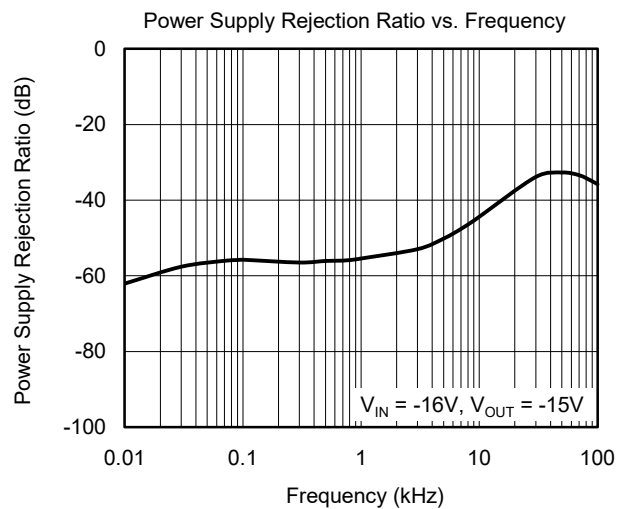
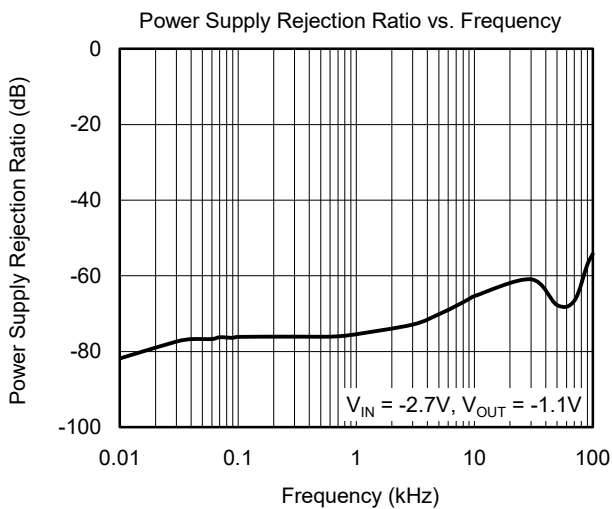
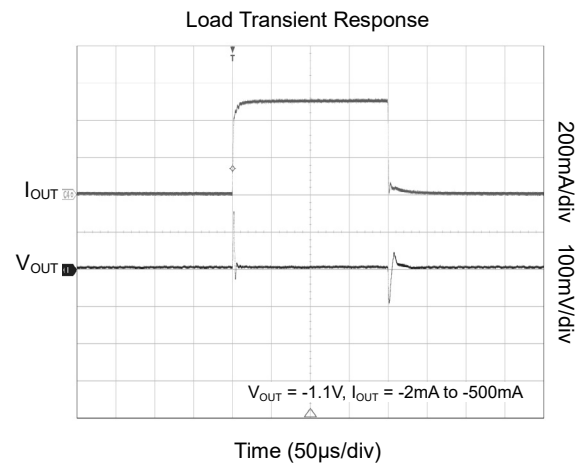
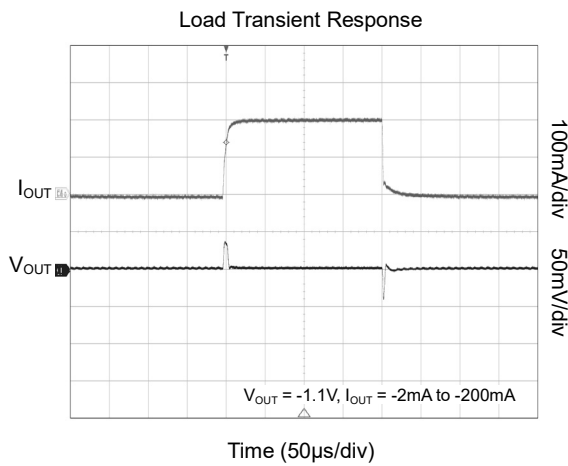
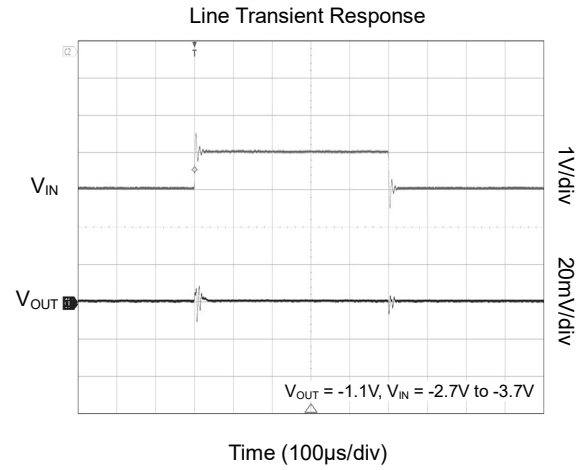
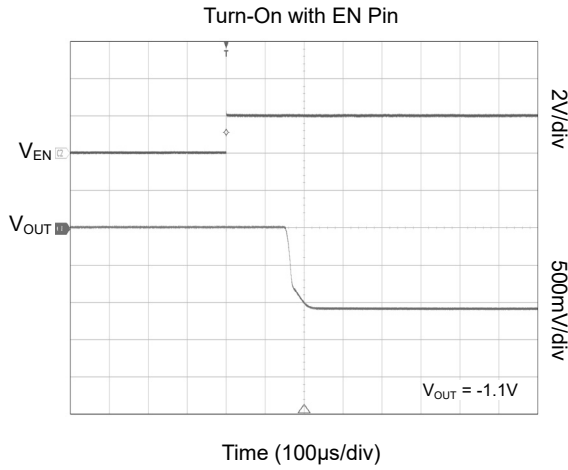

TYPICAL PERFORMANCE CHARACTERISTICS (continued)

$T_J = +25^\circ\text{C}$ ,  $V_{IN} = (V_{OUT(NOM)} - 0.5\text{V})$  or  $-2.7\text{V}$  (whichever is greater),  $V_{EN} = V_{IN}$ ,  $I_{OUT} = -10\text{mA}$ ,  $C_{IN} = 2.2\mu\text{F}$  and  $C_{OUT} = 2.2\mu\text{F}$ , unless otherwise noted.

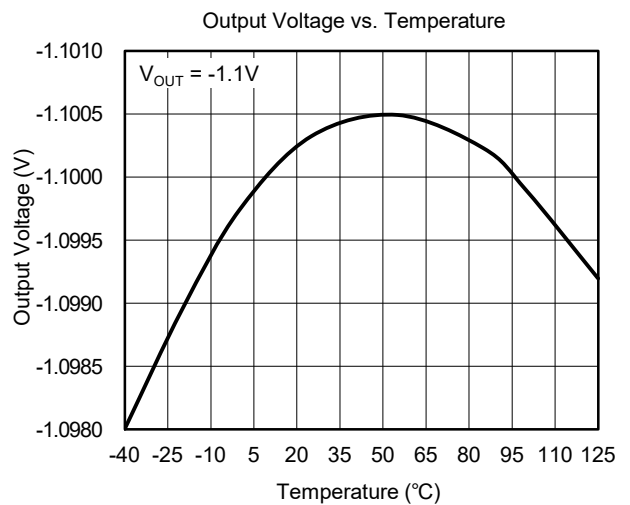
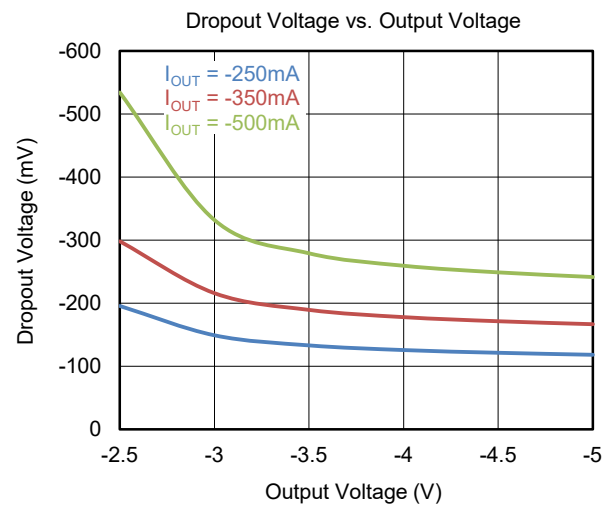
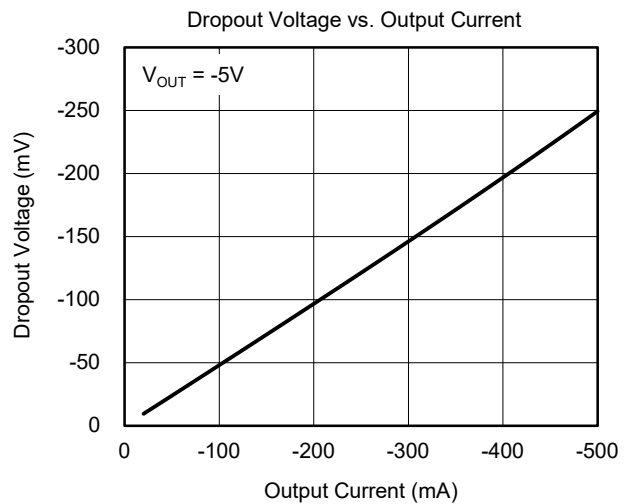
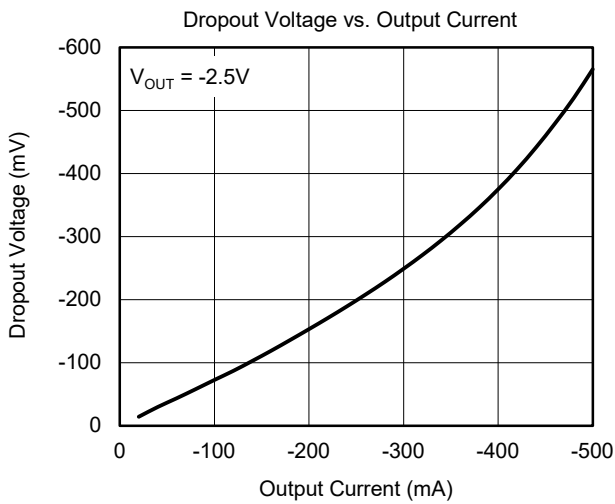
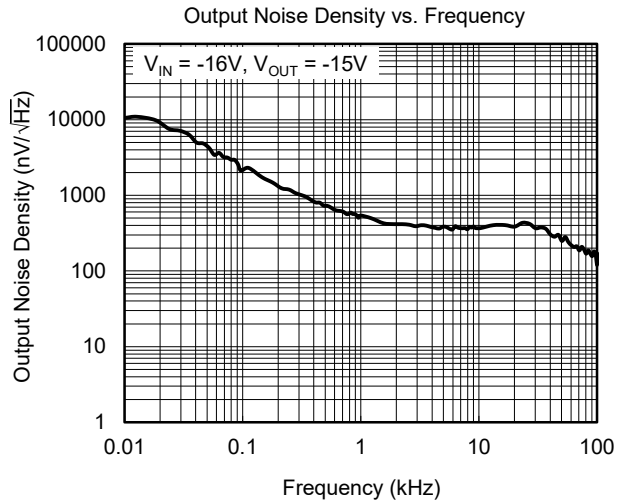
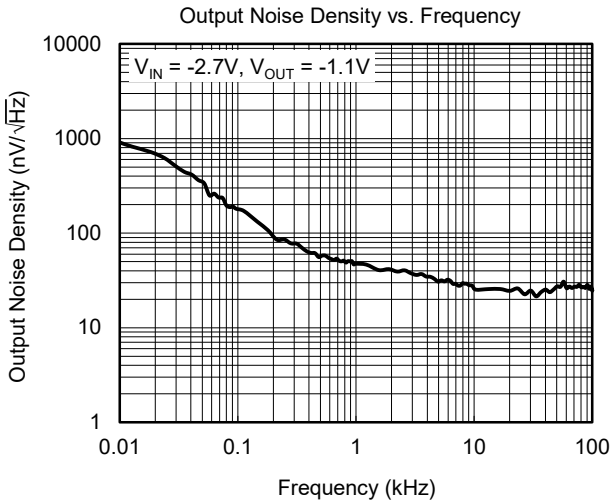



**TYPICAL PERFORMANCE CHARACTERISTICS (continued)**

$T_J = +25^\circ\text{C}$ ,  $V_{IN} = (V_{OUT(NOM)} - 0.5\text{V})$  or  $-2.7\text{V}$  (whichever is greater),  $V_{EN} = V_{IN}$ ,  $I_{OUT} = -10\text{mA}$ ,  $C_{IN} = 2.2\mu\text{F}$  and  $C_{OUT} = 2.2\mu\text{F}$ , unless otherwise noted.

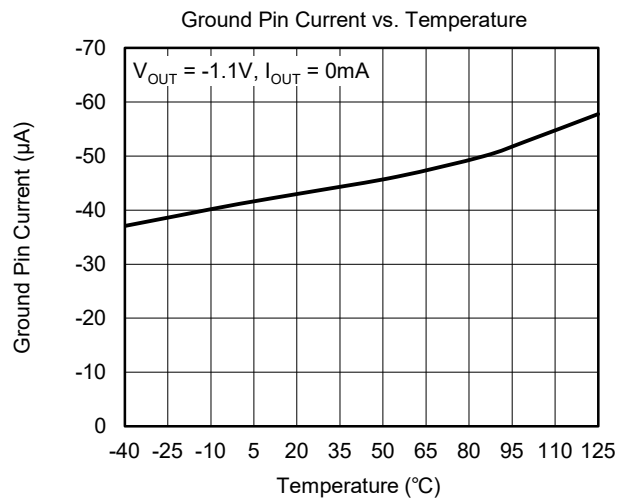
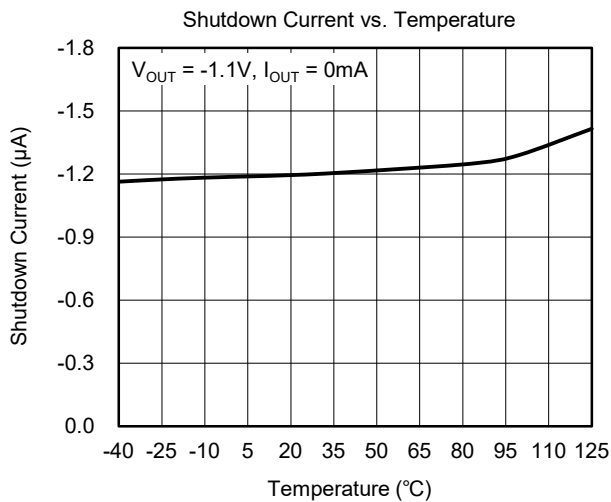
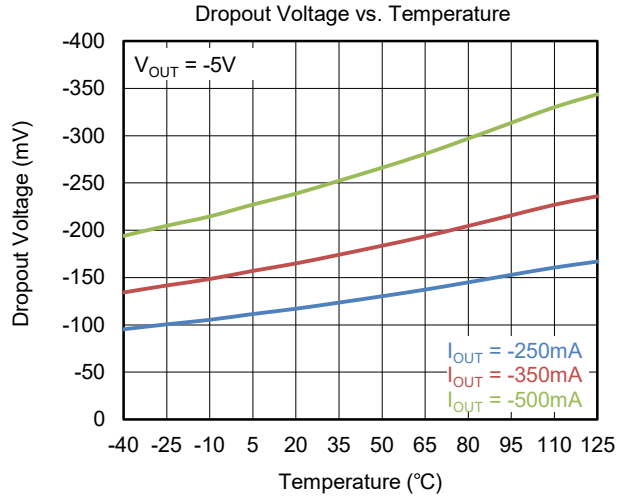
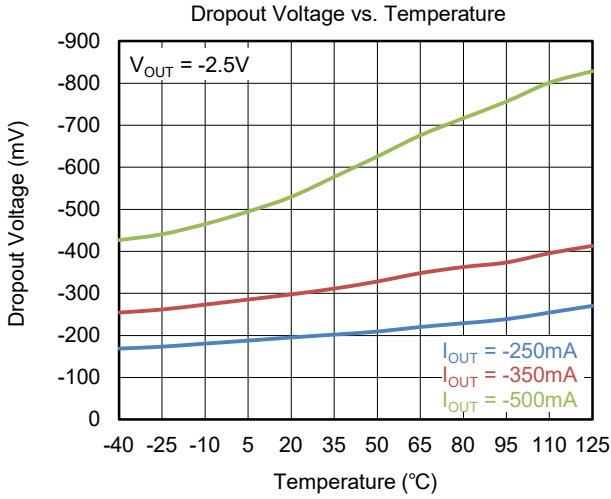

**APPLICATION INFORMATION**

The SGM2231 is a low quiescent current, low noise and low dropout LDO and provides -500mA output current. These features make the device a reliable solution to solve many challenging problems in the generation of clean and accurate power supply. The high performance also makes the SGM2231 useful in a variety of applications. The SGM2231 provides the protection functions for output overload, output short-circuit condition and overheating.

The SGM2231 provides an EN pin as an external chip enable control to enable/disable the device. When the regulator is in shutdown state, the shutdown current consumes as low as -1.2µA (TYP).

**Input Capacitor Selection (C<sub>IN</sub>)**

The input decoupling capacitor should be placed as close as possible to the IN pin to ensure the device stability. A 2.2µF or larger X7R or X5R ceramic capacitor is selected to get good dynamic performance.

When V<sub>IN</sub> is required to provide large current instantaneously, a large effective input capacitor is required. Multiple input capacitors can reduce the impact from input trace inductance. Adding more input capacitors is available to restrict the ringing and to keep it below the device absolute maximum ratings.

**Output Capacitor Selection (C<sub>OUT</sub>)**

The output capacitor should be placed as close as possible to the OUT pin. A 2.2µF or larger X7R or X5R ceramic capacitor is selected to get good dynamic performance. The minimum effective capacitance of C<sub>OUT</sub> that SGM2231 can remain stable is 1.5µF. For ceramic capacitor, temperature, DC bias and package size will change the effective capacitance, so enough margin of C<sub>OUT</sub> must be considered in design. Additionally, C<sub>OUT</sub> with larger capacitance and lower ESR will help increase the high frequency PSRR and improve the load transient response.

**Adjustable Regulator**

For the SGM2231-ADJ, set the output voltage by using a resistor divider as shown in Figure 3. Choose R<sub>2</sub> less than 110kΩ to maintain a 10µA minimum load. Calculate the value for the output voltage using the following equation:

$$V_{OUT} = -1.1V \times (1 + R_1/R_2) \tag{1}$$

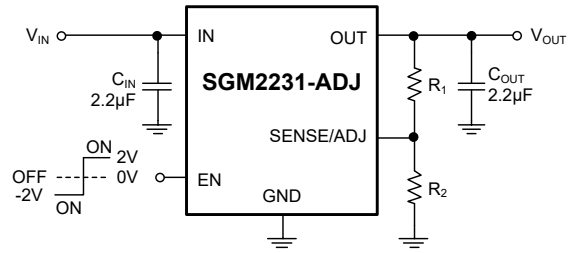

Figure 3. Adjustable Output Voltage Application

**Enable Operation**

The EN pin of the SGM2231 is used to enable/disable the OUT pin under normal operating conditions. Connect the EN pin to the IN pin when using automatic startup.

When EN is at ±2.0V with respect to GND, the device is in active state. When EN is at 0V, the device is in shutdown state. In this state, a discharge resistor around 200kΩ connects to the OUT pin and pulls the OUT pin up to GND.

The EN pin of the SGM2231 is bipolar, even though the enable voltage can be positive or negative.

The typical hysteresis of the EN pin is shown in Figure 4. This feature is used to prevent on/off oscillations due to noise on the EN pin when it passes the threshold point.

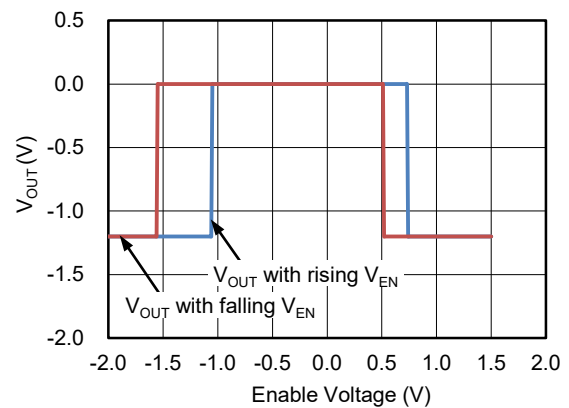

Figure 4. Typical EN Pin Operation

**APPLICATION INFORMATION (continued)**

**Reverse Current Protection**

The pass transistor has an inherent body diode which will be forward biased in the case when  $V_{OUT} < (V_{IN} - 0.3V)$ . If extended reverse voltage operation is anticipated, external limiting might be appropriate.

**Output Current Limit and Short-Circuit Protection**

When overload events happen, the output current is internally limited to -1.2A (TYP). When the OUT pin is shorted to ground, the short-circuit protection will limit the output current to -410mA (TYP).

**Thermal Shutdown**

When the die temperature exceeds the threshold value of thermal shutdown, the SGM2231 will be in shutdown state and it will remain in this state until the die temperature decreases to +140°C.

**Power Dissipation ( $P_D$ )**

Power dissipation ( $P_D$ ) of the SGM2231 can be calculated by the equation  $P_D = |V_{IN} - V_{OUT}| \times I_{OUT}$ . The maximum allowable power dissipation ( $P_{D(MAX)}$ ) of the SGM2231 is affected by many factors, including the difference between junction temperature and ambient temperature ( $T_{J(MAX)} - T_A$ ), package thermal resistance from the junction to the ambient environment ( $\theta_{JA}$ ), the rate of ambient airflow and PCB layout.  $P_{D(MAX)}$  can be approximated by the following equation:

$$P_{D(MAX)} = (T_{J(MAX)} - T_A) / \theta_{JA} \quad (2)$$

**Layout Guidelines**

To get good PSRR, low output noise and high transient response performance, the input and output bypass capacitors must be placed as close as possible to the IN pin and OUT pin separately.

**REVISION HISTORY**

NOTE: Page numbers for previous revisions may differ from page numbers in the current version.

| Changes from Original (JANUARY 2024) to REV.A        | Page |
|--|------|
| Changed from product preview to production data..... | All  |

PACKAGE OUTLINE DIMENSIONS

UTDFN-2x2-8CL

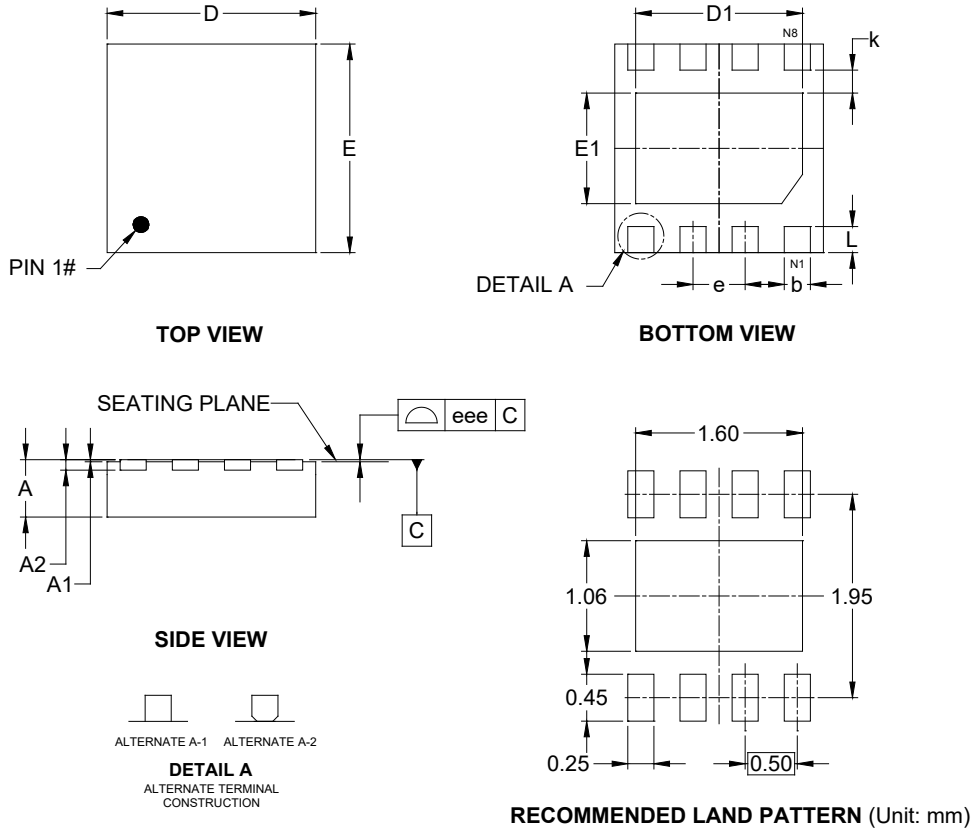

| Symbol | Dimensions In Millimeters |     |       |
|--------|---------------------------|-----|-------|
|        | MIN                       | MOD | MAX   |
| A      | 0.500                     | -   | 0.600 |
| A1     | 0.000                     | -   | 0.050 |
| A2     | 0.100 REF                 |     |       |
| b      | 0.200                     | -   | 0.300 |
| D      | 1.900                     | -   | 2.100 |
| E      | 1.900                     | -   | 2.100 |
| D1     | 1.500                     | -   | 1.700 |
| E1     | 0.960                     | -   | 1.160 |
| e      | 0.500 BSC                 |     |       |
| k      | 0.220 REF                 |     |       |
| L      | 0.150                     | -   | 0.350 |
| eee    | 0.050                     |     |       |

NOTE: This drawing is subject to change without notice.

# PACKAGE INFORMATION

## TAPE AND REEL INFORMATION

### REEL DIMENSIONS



### TAPE DIMENSIONS



NOTE: The picture is only for reference. Please make the object as the standard.

### KEY PARAMETER LIST OF TAPE AND REEL

| Package Type  | Reel Diameter | Reel Width W1 (mm) | A0 (mm) | B0 (mm) | K0 (mm) | P0 (mm) | P1 (mm) | P2 (mm) | W (mm) | Pin1 Quadrant |
|---------------|---------------|--------------------|---------|---------|---------|---------|---------|---------|--------|---------------|
| UTDFN-2x2-8CL | 7"            | 9.5                | 2.25    | 2.25    | 0.75    | 4.0     | 4.0     | 2.0     | 8.0    | Q2            |

000001

# PACKAGE INFORMATION

## CARTON BOX DIMENSIONS



NOTE: The picture is only for reference. Please make the object as the standard.

## KEY PARAMETER LIST OF CARTON BOX

| Reel Type   | Length (mm) | Width (mm) | Height (mm) | Pizza/Carton |
|-------------|-------------|------------|-------------|--------------|
| 7" (Option) | 368         | 227        | 224         | 8            |
| 7"          | 442         | 410        | 224         | 18           |

DD0002

单击下面可查看定价，库存，交付和生命周期等信息

[>>SGMICRO\(圣邦微电子\)](#)