



SGM721/SGM722/SGM723/SGM724 11MHz, Rail-to-Rail I/O CMOS Operational Amplifiers

GENERAL DESCRIPTION

The SGM721/2/3/4 are a family of single, dual and quad operational amplifiers, which are optimized for low voltage, low noise and low power operation. These devices can operate from 2.1V to 5.5V single supply, while consuming low quiescent current. The supply current of SGM723 is less than 1 μ A in power-down mode.

The SGM721/2/3/4 feature a 4mV maximum input offset voltage. The minimum input common mode voltage is within 0.1V below the negative rail, and the output swing is rail-to-rail with heavy loads. They exhibit a high gain-bandwidth product of 11MHz and a slew rate of 8.5V/ μ s. These specifications make the operational amplifiers appropriate for various applications.

The SGM721 is available in Green SC70-5, SOT-23-5 and SOIC-8 packages. The SGM722 is available in Green SOIC-8, MSOP-8 and TSSOP-8 packages. The SGM723 is available in Green SOT-23-6 and SOIC-8 packages. The SGM724 is available in Green SOIC-14 and TSSOP-14 packages. They are specified over the extended industrial temperature range (-40 °C to +125°C).

FEATURES

- **Input Offset Voltage: 4mV (MAX)**
- **High Gain-Bandwidth Product: 11MHz**
- **High Slew Rate: 8.5V/ μ s**
- **Settling Time to 0.1% with 2V Step: 0.21 μ s**
- **Overload Recovery Time: 0.6 μ s**
- **Low Noise: 8.5nV/ $\sqrt{\text{Hz}}$ at 10kHz**
- **Rail-to-Rail Input and Output**
- **Supply Voltage Range: 2.1V to 5.5V**
- **Input Voltage Range: -0.1V to 5.6V with $V_S = 5.5V$**
- **Low Power:**
 - SGM721/3: 1.2mA (TYP)
 - SGM722/4: 1.1mA/Amplifier (TYP)
 - SGM723 Less than 1 μ A when Disabled
- **-40°C to +125°C Operating Temperature Range**
- **Small Packaging:**
 - SGM721 Available in Green SC70-5, SOT-23-5 and SOIC-8 Packages
 - SGM722 Available in Green MSOP-8, SOIC-8 and TSSOP-8 Packages
 - SGM723 Available in Green SOT-23-6 and SOIC-8 Packages
 - SGM724 Available in Green TSSOP-14 and SOIC-14 Packages

APPLICATIONS

Sensors
Audio
Active Filters
A/D Converters
Communications
Test Equipment
Cellular and Cordless Phones
Laptops and PDAs
Photodiode Amplification
Battery-Powered Instrumentation

PACKAGE/ORDERING INFORMATION

MODEL	PACKAGE DESCRIPTION	SPECIFIED TEMPERATURE RANGE	ORDERING NUMBER	PACKAGE MARKING	PACKING OPTION
SGM721	SC70-5	-40°C to +125°C	SGM721XC5/TR	721	Tape and Reel, 3000
	SOT-23-5	-40°C to +125°C	SGM721XN5/TR	721	Tape and Reel, 3000
	SOIC-8	-40°C to +125°C	SGM721XS/TR	SGM721XS XXXXX	Tape and Reel, 2500
SGM722	MSOP-8	-40°C to +125°C	SGM722XMS/TR	SGM722 XMS XXXXX	Tape and Reel, 3000
	SOIC-8	-40°C to +125°C	SGM722XS/TR	SGM722XS XXXXX	Tape and Reel, 2500
	TSSOP-8	-40°C to +125°C	SGM722XTS8G/TR	SGM722 XTS8 XXXXX	Tape and Reel, 4000
SGM723	SOT-23-6	-40°C to +125°C	SGM723XN6/TR	723	Tape and Reel, 3000
	SOIC-8	-40°C to +125°C	SGM723XS/TR	SGM723XS XXXXX	Tape and Reel, 2500
SGM724	SOIC-14	-40°C to +125°C	SGM724XS14/TR	SGM724XS14 XXXXX	Tape and Reel, 2500
	TSSOP-14	-40°C to +125°C	SGM724XTS14/TR	SGM724 XTS14 XXXXX	Tape and Reel, 3000

MARKING INFORMATION

SOIC-8/MSOP-8/TSSOP-8/SOIC-14/TSSOP-14

(1) XXXXX = Date Code and Vendor Code.

XXXXX

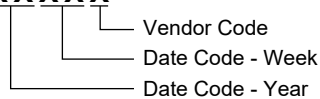

SGM722: SOIC-8

(2) XXXXX = Date Code, Trace Code and Vendor Code.

XXXXX



Green (RoHS & HSF): SG Micro Corp defines "Green" to mean Pb-Free (RoHS compatible) and free of halogen substances. If you have additional comments or questions, please contact your SGMICRO representative directly.

ABSOLUTE MAXIMUM RATINGS

Supply Voltage, +V _S to -V _S	7V
Input Common Mode Voltage Range	(-V _S) - 0.3V to (+V _S) + 0.3V
Package Thermal Resistance @ T _A = +25°C	
SC70-5, θ _{JA}	333°C/W
SOT-23-5, θ _{JA}	190°C/W
SOT-23-6, θ _{JA}	190°C/W
SOIC-8, θ _{JA}	125°C/W
MSOP-8, θ _{JA}	216°C/W
TSSOP-8, θ _{JA}	170°C/W
Junction Temperature.....	+150°C
Storage Temperature Range	-65°C to +150°C
Lead Temperature (Soldering, 10s).....	+260°C
ESD Susceptibility	
HBM (SGM721/2/4).....	8000V
HBM (SGM723)	4000V
MM.....	400V
CDM	1000V

RECOMMENDED OPERATING CONDITIONS

Operating Temperature Range	-40°C to +125°C
-----------------------------------	-----------------

OVERSTRESS CAUTION

Stresses beyond those listed in Absolute Maximum Ratings may cause permanent damage to the device. Exposure to absolute maximum rating conditions for extended periods may affect reliability. Functional operation of the device at any conditions beyond those indicated in the Recommended Operating Conditions section is not implied.

ESD SENSITIVITY CAUTION

This integrated circuit can be damaged if ESD protections are not considered carefully. SGMICRO recommends that all integrated circuits be handled with appropriate precautions. Failure to observe proper handling and installation procedures can cause damage. ESD damage can range from subtle performance degradation to complete device failure. Precision integrated circuits may be more susceptible to damage because even small parametric changes could cause the device not to meet the published specifications.

DISCLAIMER

SG Micro Corp reserves the right to make any change in circuit design, or specifications without prior notice.

PIN CONFIGURATIONS

SGM721 (TOP VIEW)

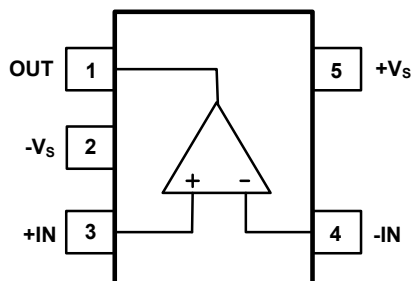

SC70-5/SOT-23-5

SGM721/723 (TOP VIEW)

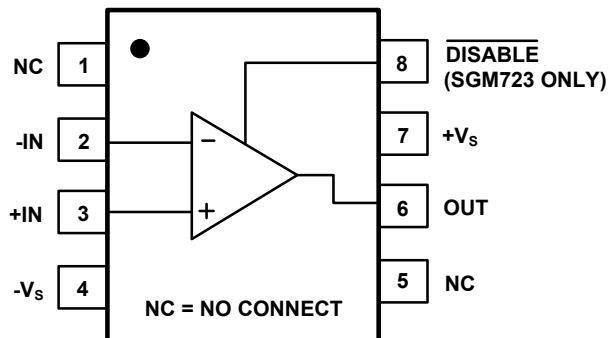

SOIC-8

SGM723 (TOP VIEW)

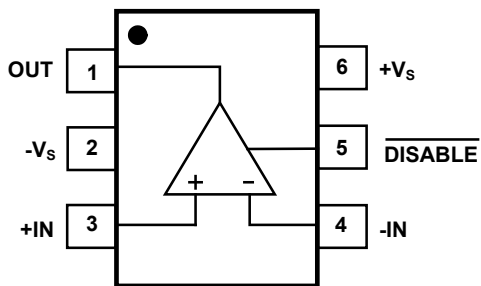

SOT-23-6

SGM722 (TOP VIEW)

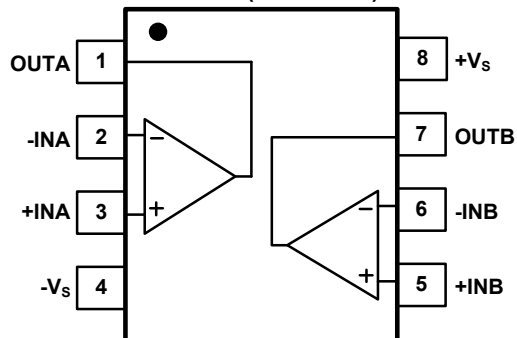

SOIC-8/MSOP-8/TSSOP-8

SGM724 (TOP VIEW)

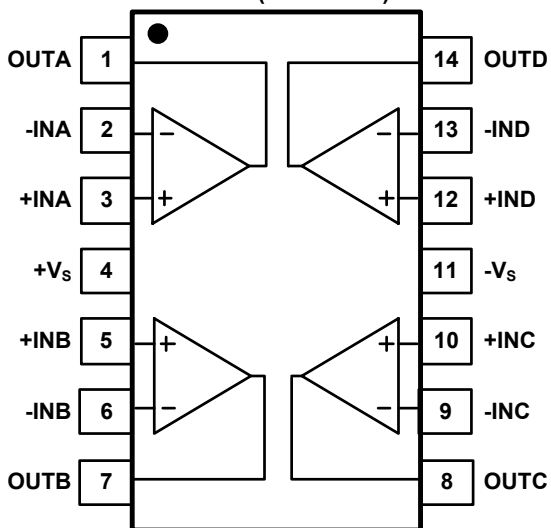

TSSOP-14/SOIC-14

ELECTRICAL CHARACTERISTICS

(At $T_A = +25^\circ\text{C}$, $V_S = +5\text{V}$, $V_{CM} = V_S/2$, $R_L = 600\Omega$, unless otherwise noted.)

PARAMETER	CONDITIONS	SGM721/2/3/4						
		TYP	MIN/MAX OVER TEMPERATURE				UNITS	MIN/ MAX
		+25°C	+25°C	-40°C to +85°C	-40°C to +125°C			
Input Characteristics								
Input Offset Voltage (V_{OS})		1.5	4	4.3	4.6	mV	MAX	
Input Bias Current (I_B)		1				pA	TYP	
Input Offset Current (I_{OS})		1				pA	TYP	
Input Common Mode Voltage Range (V_{CM})	$V_S = 5.5\text{V}$	-0.1 to 5.6				V	TYP	
Common Mode Rejection Ratio (CMRR)	$V_S = 5.5\text{V}$, $V_{CM} = -0.1\text{V}$ to 4V	83	67	66	65	dB	MIN	
	$V_S = 5.5\text{V}$, $V_{CM} = -0.1\text{V}$ to 5.6V	75	60	59	56	dB	MIN	
Open-Loop Voltage Gain (A_{OL})	$R_L = 600\Omega$, $V_{OUT} = 0.15\text{V}$ to 4.85V	89	82	74	71	dB	MIN	
	$R_L = 10\text{k}\Omega$, $V_{OUT} = 0.05\text{V}$ to 4.95V	102	96	85	83	dB	MIN	
Input Offset Voltage Drift ($\Delta V_{OS}/\Delta T$)		2.1				$\mu\text{V}/^\circ\text{C}$	TYP	
Output Characteristics								
Output Voltage Swing from Rail	$R_L = 600\Omega$	0.076				V	TYP	
	$R_L = 10\text{k}\Omega$	0.006				V	TYP	
Output Current (I_{OUT})		67	52	42	36	mA	MIN	
Closed-Loop Output Impedance	$f = 1\text{MHz}$, $G = 1$	8.5				Ω	TYP	
Power-Down Disable (SGM723 Only)								
Turn-On Time		1.1				μs	TYP	
Turn-Off Time		0.3				μs	TYP	
$\overline{\text{DISABLE}}$ Voltage-Off			0.8			V	MAX	
$\overline{\text{DISABLE}}$ Voltage-On			2			V	MIN	
Power Supply								
Operating Voltage Range		2.1	2.1	2.1	2.1	V	MIN	
		5.5	5.5	5.5	5.5	V	MAX	
Power Supply Rejection Ratio (PSRR)	$V_S = 2.1\text{V}$ to 5.5V , $V_{CM} = (-V_S) + 0.5\text{V}$	82	68	67	64	dB	MIN	
Quiescent Current/Amplifier (I_Q)	SGM722/4 $I_{OUT} = 0$	1.10	1.40	1.60	1.75	mA	MAX	
	SGM721/3 $I_{OUT} = 0$	1.2	1.5	1.7	1.85	mA	MAX	
Supply Current when Disabled (SGM723 only)		0.5	8	9	10	μA	MAX	
Dynamic Performance								
Gain-Bandwidth Product (GBP)		11				MHz	TYP	
Phase Margin (ϕ_o)		62				$^\circ$	TYP	
Full-Power Bandwidth (BW_P)	< 1% distortion	400				kHz	TYP	
Slew Rate (SR)	$G = 1$, 2V output step	8.5				$\text{V}/\mu\text{s}$	TYP	
Settling Time to 0.1% (t_s)	$G = 1$, 2V output step	0.21				μs	TYP	
Overload Recovery Time	$V_{IN} \times G = V_S$	0.6				μs	TYP	
Noise Performance								
Input Voltage Noise Density (e_n)	$f = 1\text{kHz}$	12.5				$\text{nV}/\sqrt{\text{Hz}}$	TYP	
	$f = 10\text{kHz}$	8.5				$\text{nV}/\sqrt{\text{Hz}}$	TYP	

TYPICAL PERFORMANCE CHARACTERISTICS

At $T_A = +25^\circ\text{C}$, $V_{CM} = V_S/2$, $R_L = 600\Omega$, unless otherwise noted.

Supply Current vs. Temperature

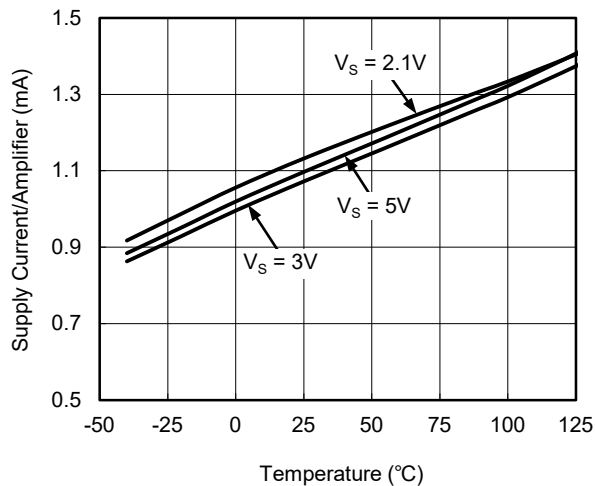

Shutdown Current vs. Temperature

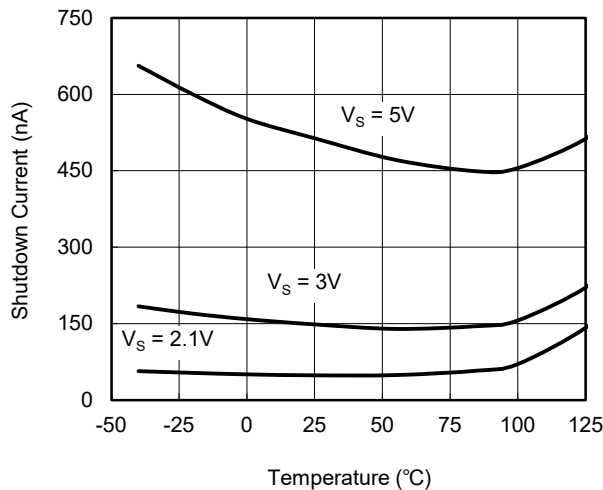

CMRR vs. Temperature

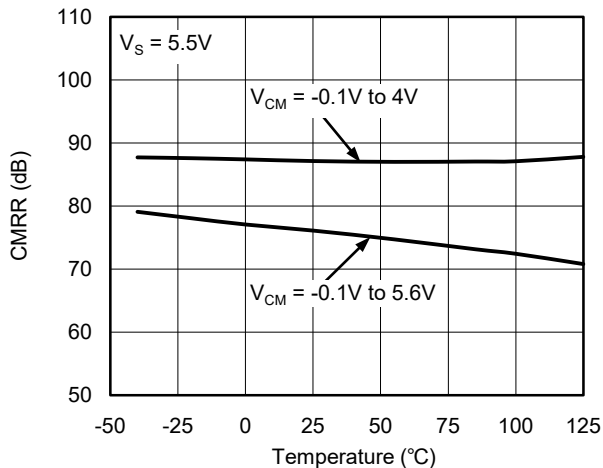

PSRR vs. Temperature

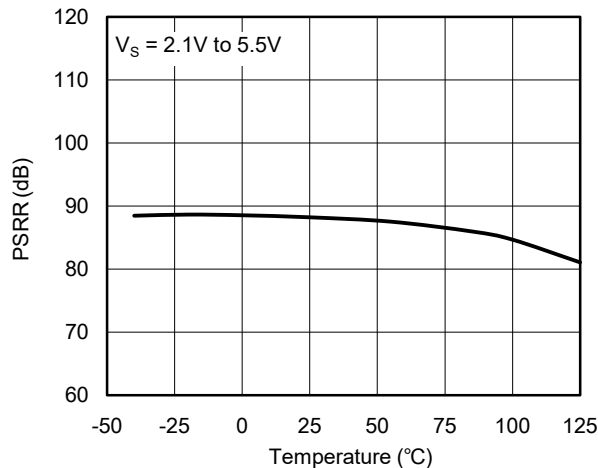

Open-Loop Voltage Gain vs. Temperature

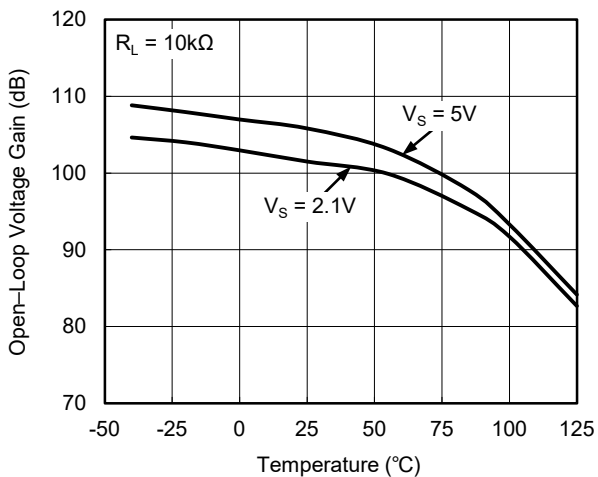

Open-Loop Voltage Gain vs. Temperature

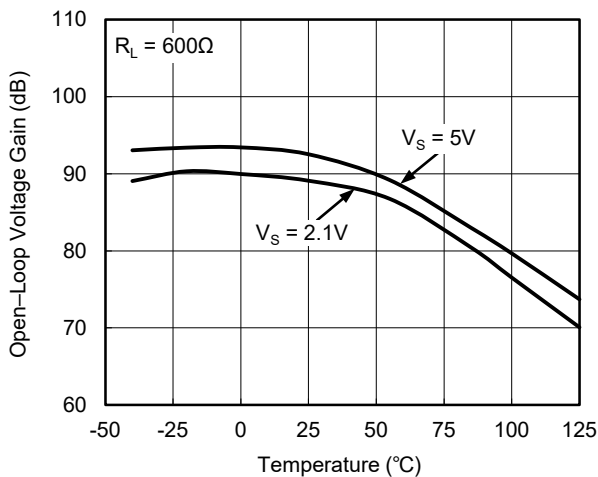

TYPICAL PERFORMANCE CHARACTERISTICS (continued)

At $T_A = +25^\circ\text{C}$, $V_{CM} = V_S/2$, $R_L = 600\Omega$, unless otherwise noted.

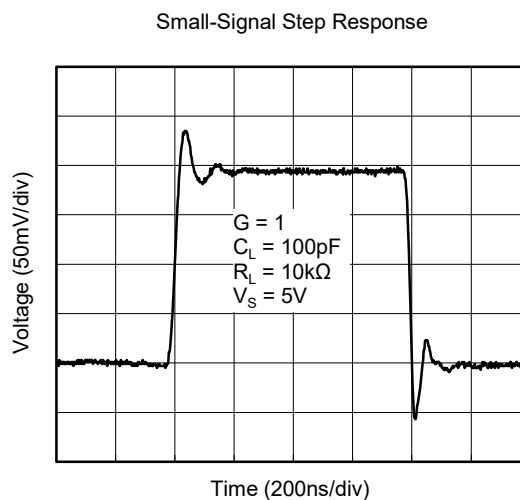
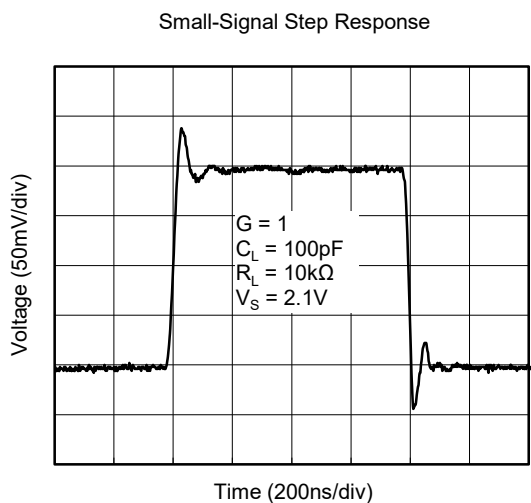
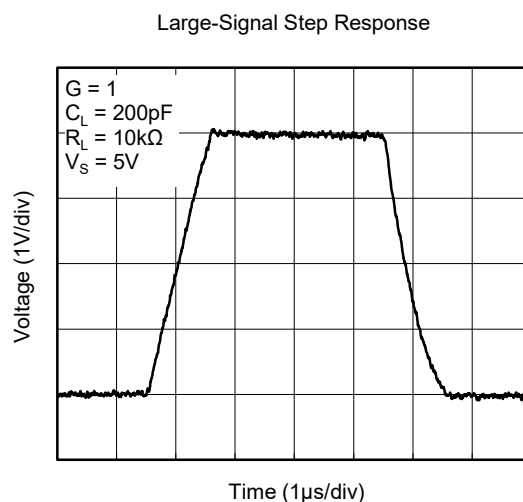
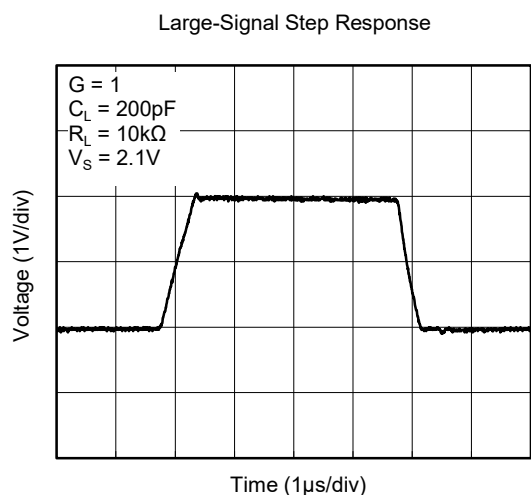
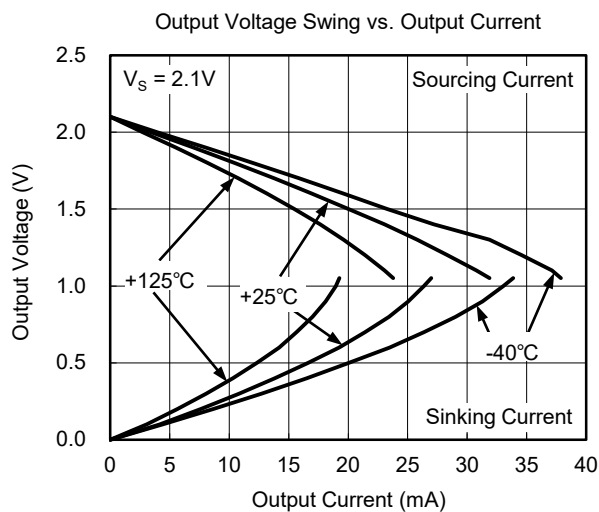
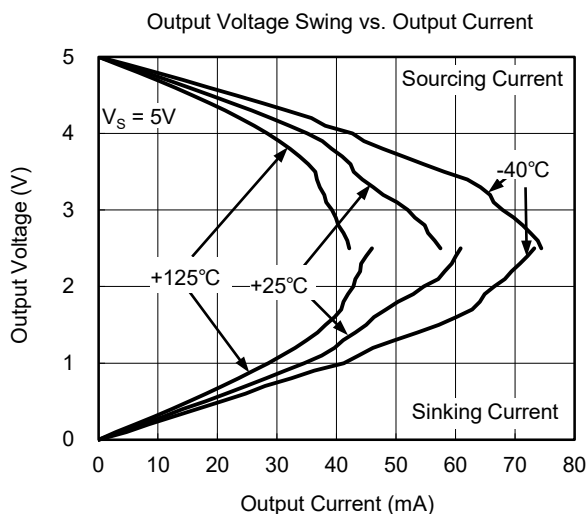

TYPICAL PERFORMANCE CHARACTERISTICS (continued)

At $T_A = +25^\circ\text{C}$, $V_{CM} = V_S/2$, $R_L = 600\Omega$, unless otherwise noted.

Positive Overload Recovery

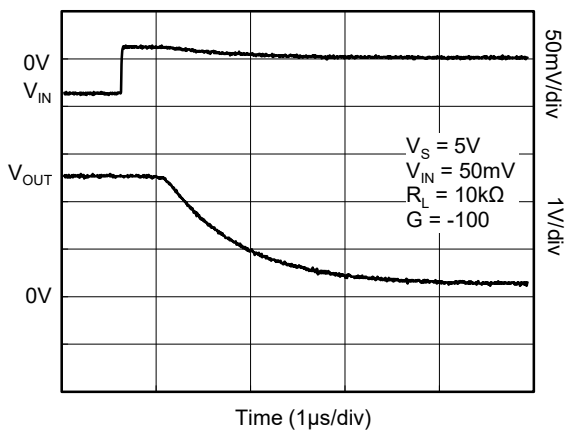

Negative Overload Recovery

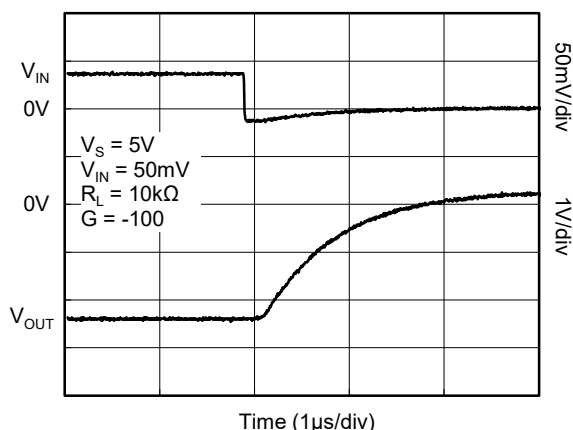

CMRR vs. Frequency

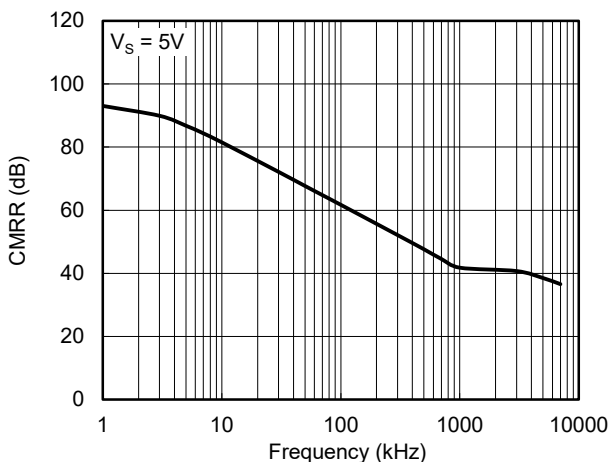

PSRR vs. Frequency

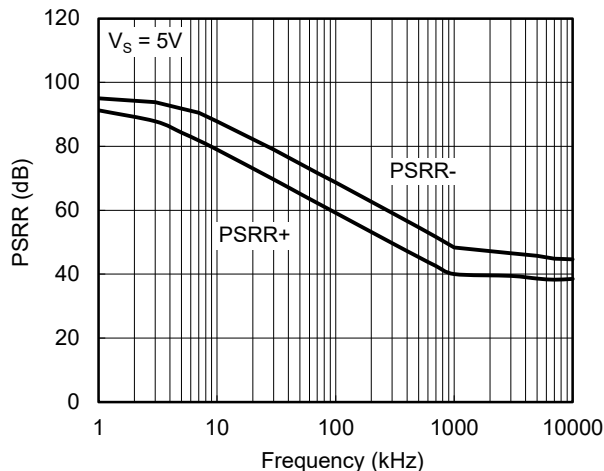

Channel Separation vs. Frequency

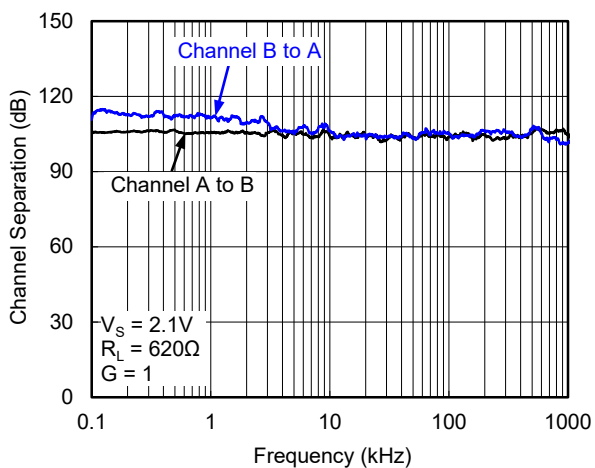

Channel Separation vs. Frequency

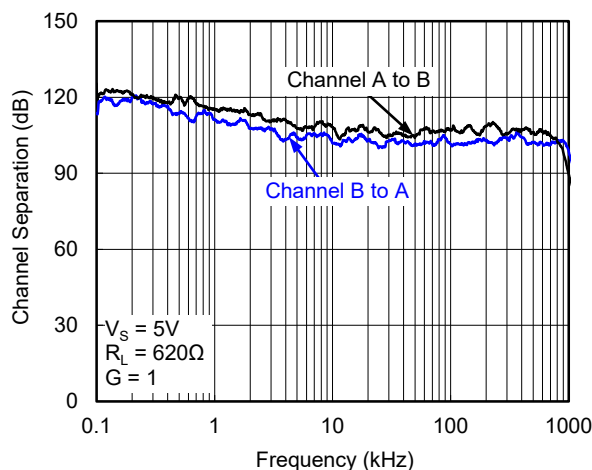

TYPICAL PERFORMANCE CHARACTERISTICS (continued)

At $T_A = +25^\circ\text{C}$, $V_{CM} = V_S/2$, $R_L = 600\Omega$, unless otherwise noted.

Closed-Loop Output Voltage Swing

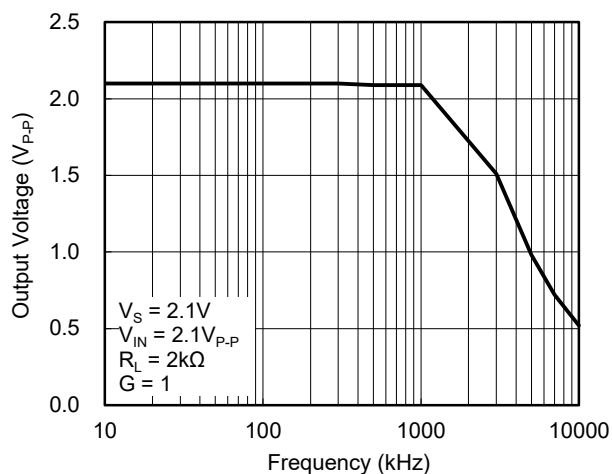

Closed-Loop Output Voltage Swing

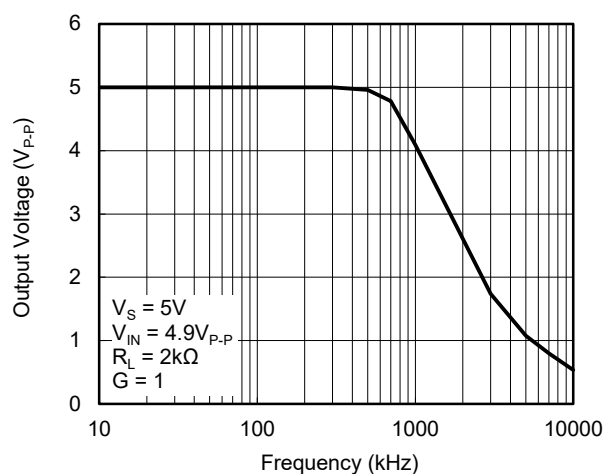

Input Voltage Noise Density vs. Frequency

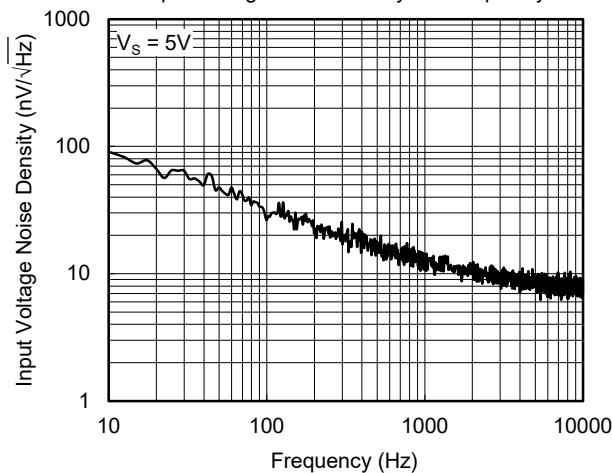

Open-Loop Gain and Phase vs. Frequency

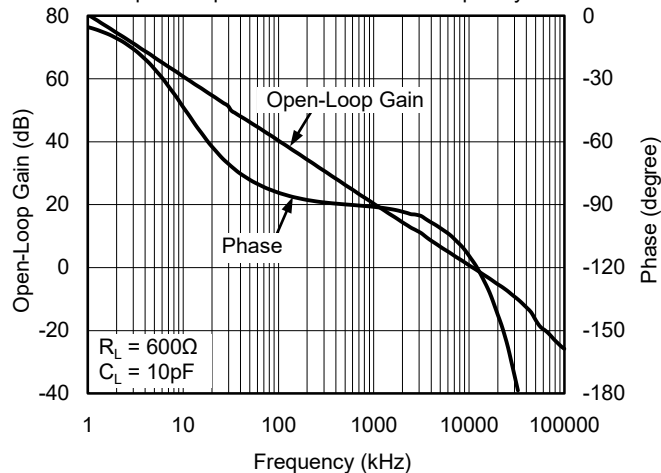

Output Impedance vs. Frequency

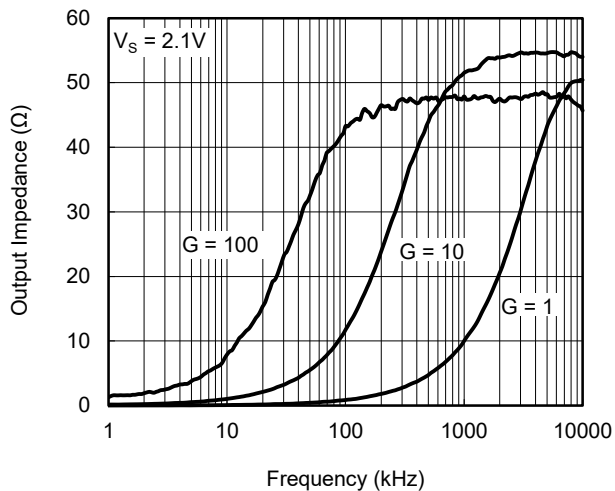

Output Impedance vs. Frequency

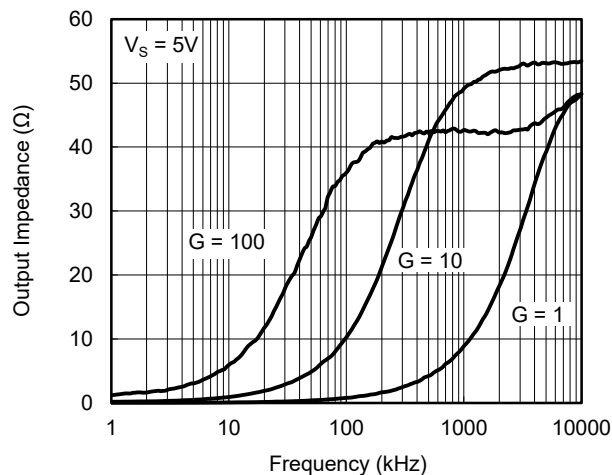

TYPICAL PERFORMANCE CHARACTERISTICS (continued)

At $T_A = +25^\circ\text{C}$, $V_{CM} = V_S/2$, $R_L = 600\Omega$, unless otherwise noted.

Small-Signal Overshoot vs. Load Capacitance

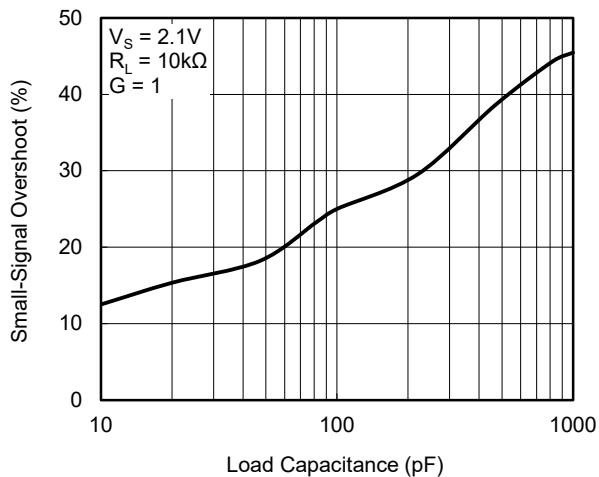

Small-Signal Overshoot vs. Load Capacitance

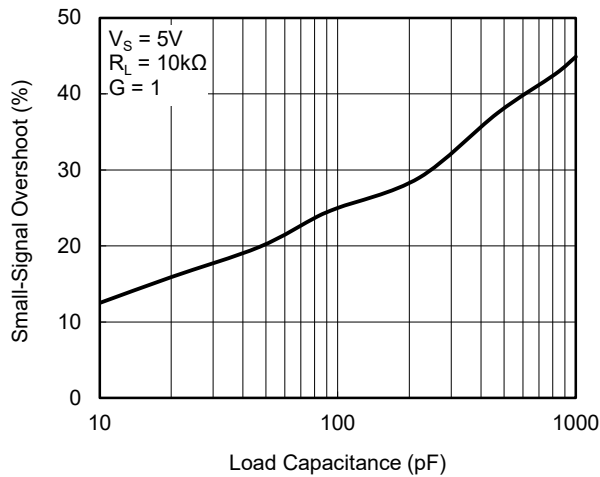

Input Offset Voltage Production Distribution

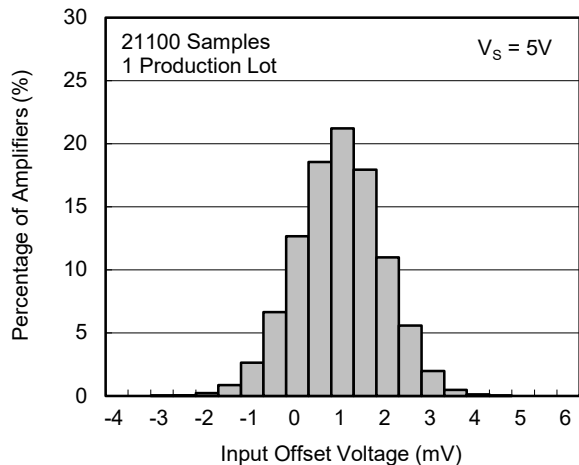

REVISION HISTORY

NOTE: Page numbers for previous revisions may differ from page numbers in the current version.

	Page
NOVEMBER 2020 – REV.C.3 to REV.C.4	
Updated Marking Information section.....	2
NOVEMBER 2019 – REV.C.2 to REV.C.3	Page
Updated Absolute Maximum Ratings section.....	3
JANUARY 2018 – REV.C.1 to REV.C.2	Page
Added Open-Loop Gain and Phase vs. Frequency.....	9
SEPTEMBER 2017 – REV.C to REV.C.1	Page
Changed Supply Voltage.....	2

PACKAGE OUTLINE DIMENSIONS

SC70-5

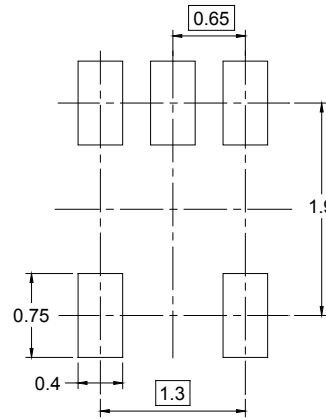
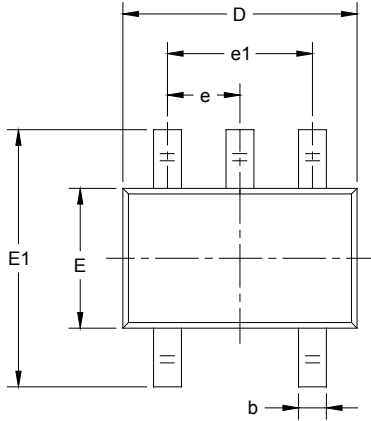

RECOMMENDED LAND PATTERN (Unit: mm)

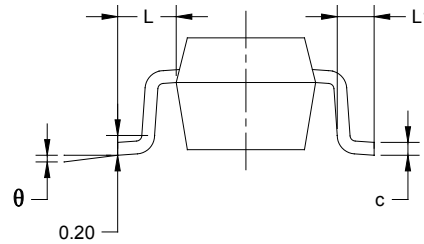
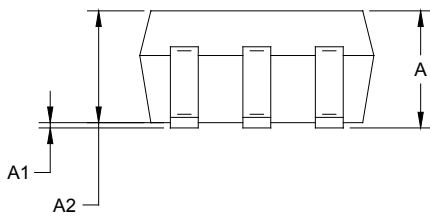

Symbol	Dimensions In Millimeters		Dimensions In Inches	
	MIN	MAX	MIN	MAX
A	0.900	1.100	0.035	0.043
A1	0.000	0.100	0.000	0.004
A2	0.900	1.000	0.035	0.039
b	0.150	0.350	0.006	0.014
c	0.080	0.150	0.003	0.006
D	2.000	2.200	0.079	0.087
E	1.150	1.350	0.045	0.053
E1	2.150	2.450	0.085	0.096
e	0.65 TYP		0.026 TYP	
e1	1.300 BSC		0.051 BSC	
L	0.525 REF		0.021 REF	
L1	0.260	0.460	0.010	0.018
θ	0°	8°	0°	8°

PACKAGE OUTLINE DIMENSIONS

SOT-23-5

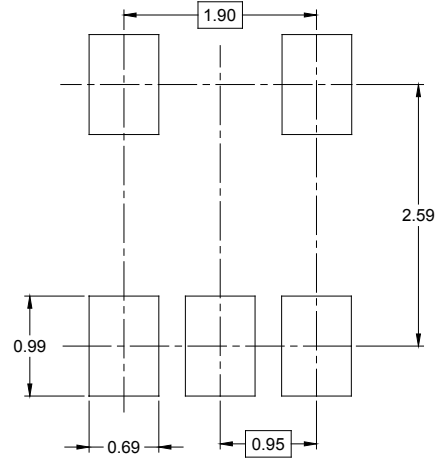
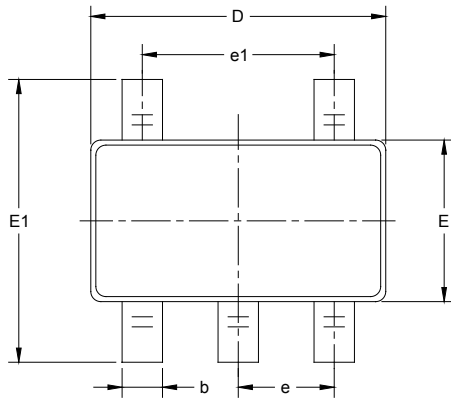

RECOMMENDED LAND PATTERN (Unit: mm)

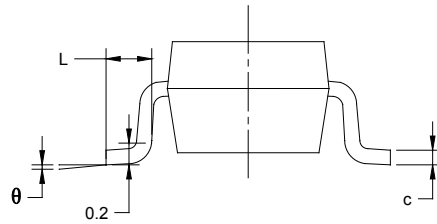
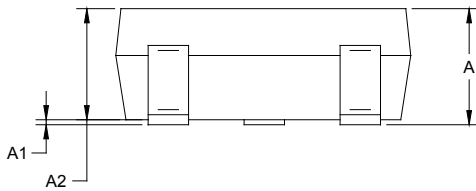

Symbol	Dimensions In Millimeters		Dimensions In Inches	
	MIN	MAX	MIN	MAX
A	1.050	1.250	0.041	0.049
A1	0.000	0.100	0.000	0.004
A2	1.050	1.150	0.041	0.045
b	0.300	0.500	0.012	0.020
c	0.100	0.200	0.004	0.008
D	2.820	3.020	0.111	0.119
E	1.500	1.700	0.059	0.067
E1	2.650	2.950	0.104	0.116
e	0.950 BSC		0.037 BSC	
e1	1.900 BSC		0.075 BSC	
L	0.300	0.600	0.012	0.024
θ	0°	8°	0°	8°

PACKAGE OUTLINE DIMENSIONS

SOT-23-6

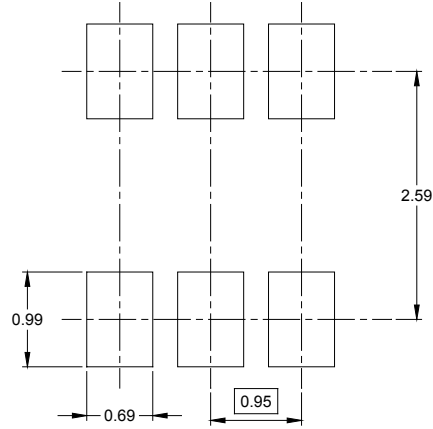
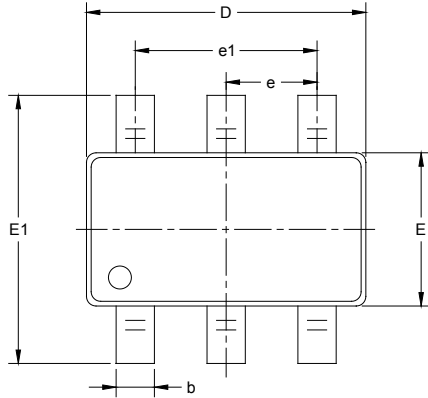

RECOMMENDED LAND PATTERN (Unit: mm)

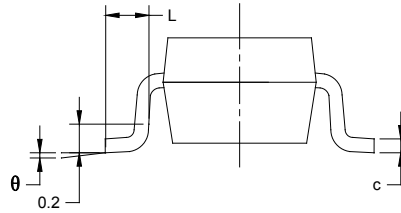
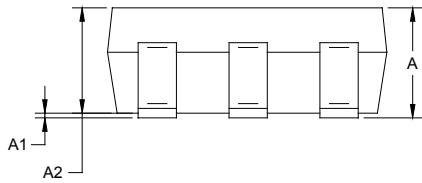

Symbol	Dimensions In Millimeters		Dimensions In Inches	
	MIN	MAX	MIN	MAX
A	1.050	1.250	0.041	0.049
A1	0.000	0.100	0.000	0.004
A2	1.050	1.150	0.041	0.045
b	0.300	0.500	0.012	0.020
c	0.100	0.200	0.004	0.008
D	2.820	3.020	0.111	0.119
E	1.500	1.700	0.059	0.067
E1	2.650	2.950	0.104	0.116
e	0.950 BSC		0.037 BSC	
e1	1.900 BSC		0.075 BSC	
L	0.300	0.600	0.012	0.024
θ	0°	8°	0°	8°

PACKAGE OUTLINE DIMENSIONS

MSOP-8

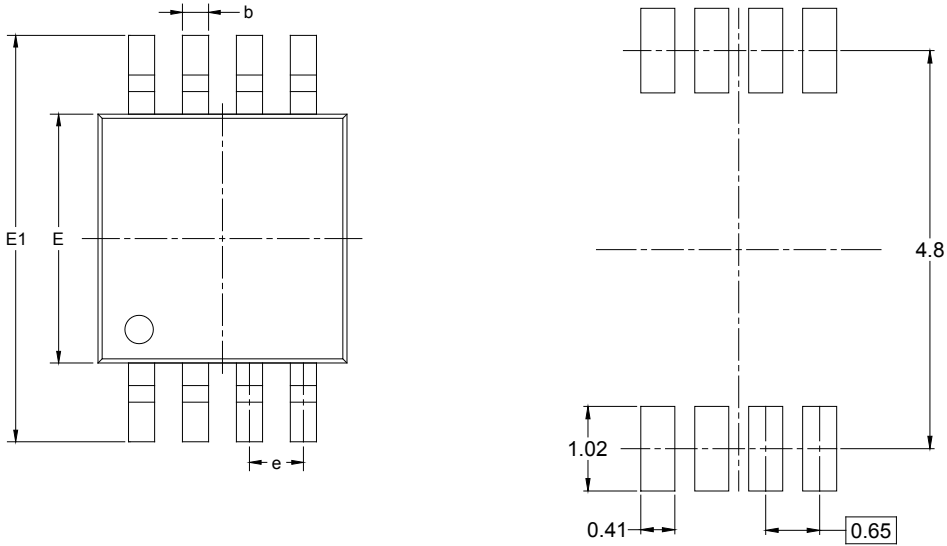

RECOMMENDED LAND PATTERN (Unit: mm)

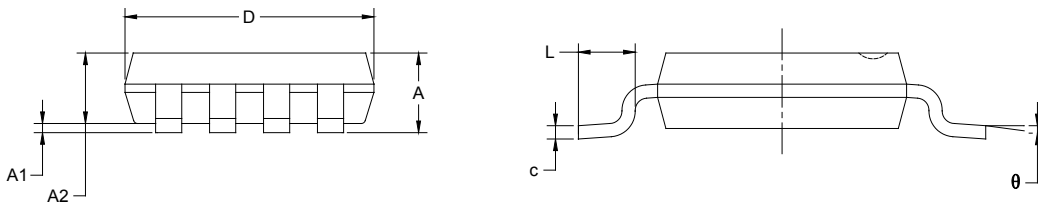

Symbol	Dimensions In Millimeters		Dimensions In Inches	
	MIN	MAX	MIN	MAX
A	0.820	1.100	0.032	0.043
A1	0.020	0.150	0.001	0.006
A2	0.750	0.950	0.030	0.037
b	0.250	0.380	0.010	0.015
c	0.090	0.230	0.004	0.009
D	2.900	3.100	0.114	0.122
E	2.900	3.100	0.114	0.122
E1	4.750	5.050	0.187	0.199
e	0.650 BSC		0.026 BSC	
L	0.400	0.800	0.016	0.031
θ	0°	6°	0°	6°

PACKAGE OUTLINE DIMENSIONS

TSSOP-8

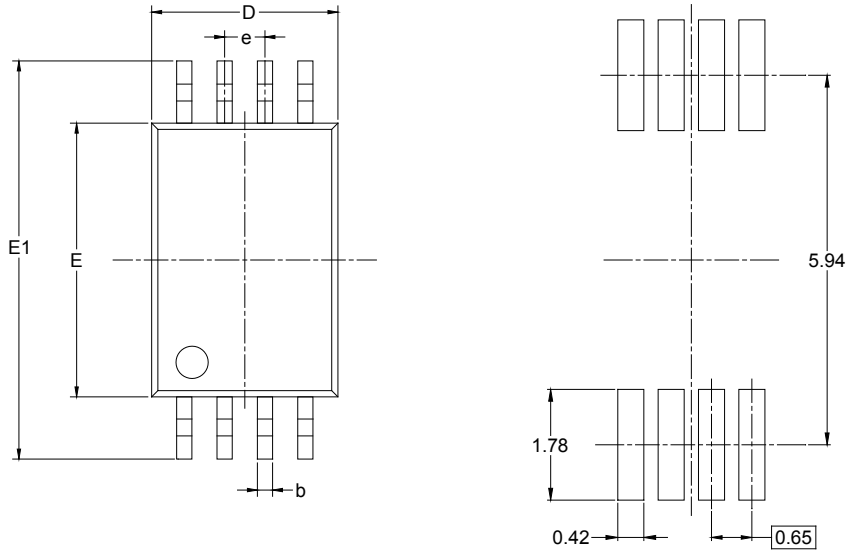

RECOMMENDED LAND PATTERN (Unit: mm)

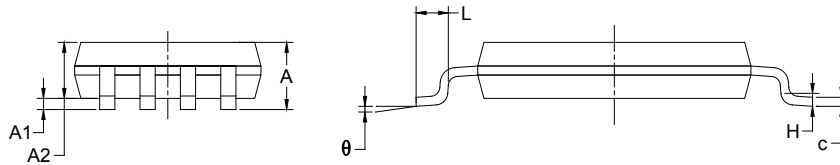

Symbol	Dimensions In Millimeters		Dimensions In Inches	
	MIN	MAX	MIN	MAX
A		1.100		0.043
A1	0.050	0.150	0.002	0.006
A2	0.800	1.000	0.031	0.039
b	0.190	0.300	0.007	0.012
c	0.090	0.200	0.004	0.008
D	2.900	3.100	0.114	0.122
E	4.300	4.500	0.169	0.177
E1	6.250	6.550	0.246	0.258
e	0.650 BSC		0.026 BSC	
L	0.500	0.700	0.02	0.028
H	0.25 TYP		0.01 TYP	
θ	1°	7°	1°	7°

PACKAGE OUTLINE DIMENSIONS

SOIC-8

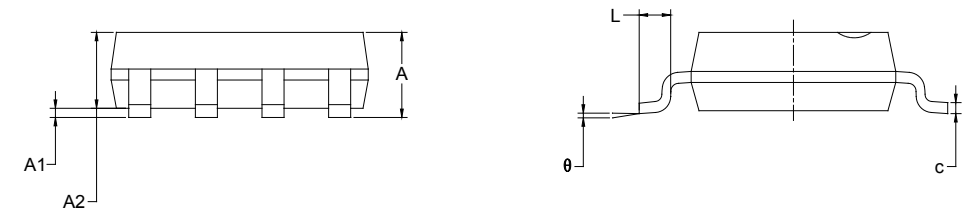
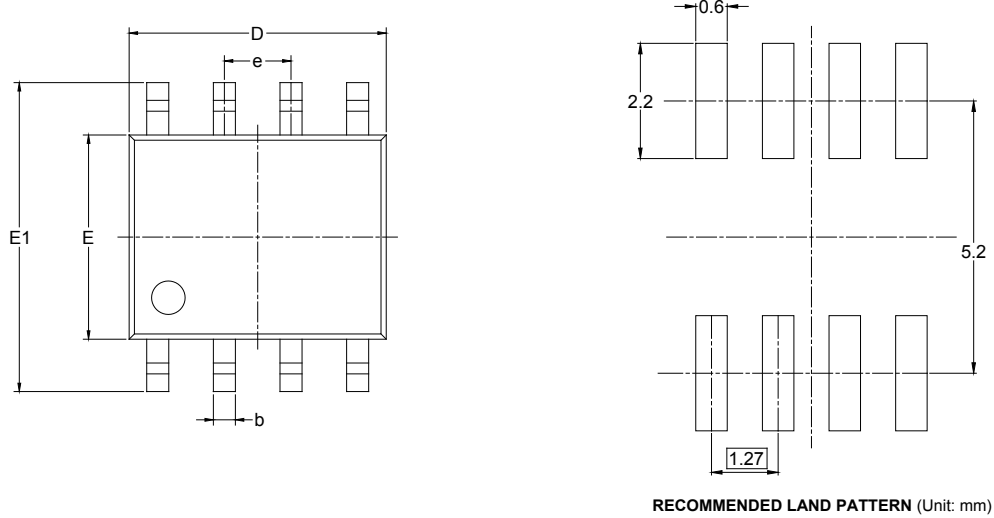

Symbol	Dimensions In Millimeters		Dimensions In Inches	
	MIN	MAX	MIN	MAX
A	1.350	1.750	0.053	0.069
A1	0.100	0.250	0.004	0.010
A2	1.350	1.550	0.053	0.061
b	0.330	0.510	0.013	0.020
c	0.170	0.250	0.006	0.010
D	4.700	5.100	0.185	0.200
E	3.800	4.000	0.150	0.157
E1	5.800	6.200	0.228	0.244
e	1.27 BSC		0.050 BSC	
L	0.400	1.270	0.016	0.050
θ	0°	8°	0°	8°

PACKAGE OUTLINE DIMENSIONS

TSSOP-14

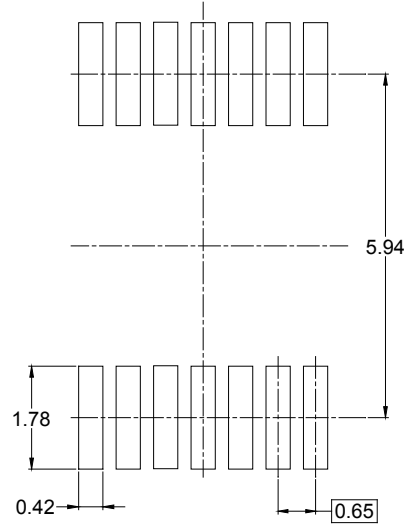
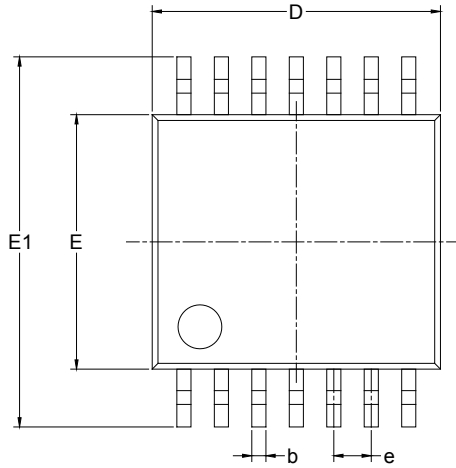

RECOMMENDED LAND PATTERN (Unit: mm)

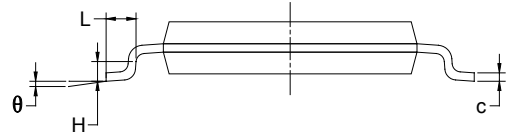
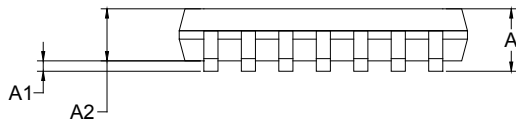

Symbol	Dimensions In Millimeters		Dimensions In Inches	
	MIN	MAX	MIN	MAX
A		1.200		0.047
A1	0.050	0.150	0.002	0.006
A2	0.800	1.050	0.031	0.041
b	0.190	0.300	0.007	0.012
c	0.090	0.200	0.004	0.008
D	4.860	5.100	0.191	0.201
E	4.300	4.500	0.169	0.177
E1	6.250	6.550	0.246	0.258
e	0.650 BSC		0.026 BSC	
L	0.500	0.700	0.02	0.028
H	0.25 TYP		0.01 TYP	
θ	1°	7°	1°	7°

PACKAGE INFORMATION

PACKAGE OUTLINE DIMENSIONS

SOIC-14

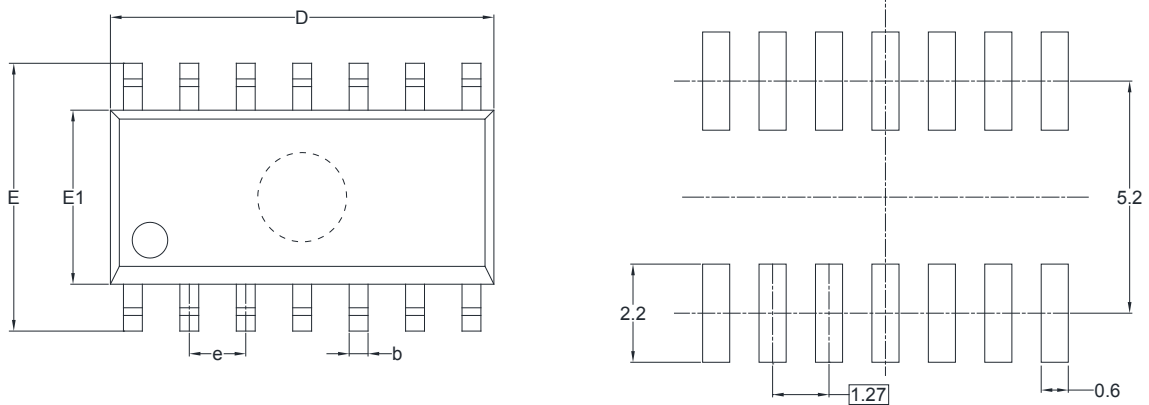

RECOMMENDED LAND PATTERN (Unit: mm)

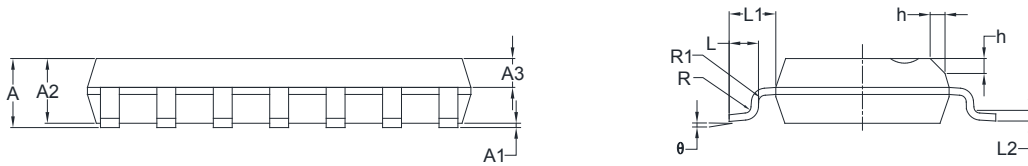

Symbol	Dimensions In Millimeters		Dimensions In Inches	
	MIN	MAX	MIN	MAX
A	1.35	1.75	0.053	0.069
A1	0.10	0.25	0.004	0.010
A2	1.25	1.65	0.049	0.065
A3	0.55	0.75	0.022	0.030
b	0.36	0.49	0.014	0.019
D	8.53	8.73	0.336	0.344
E	5.80	6.20	0.228	0.244
E1	3.80	4.00	0.150	0.157
e	1.27 BSC		0.050 BSC	
L	0.45	0.80	0.018	0.032
L1	1.04 REF		0.040 REF	
L2	0.25 BSC		0.01 BSC	
R	0.07		0.003	
R1	0.07		0.003	
h	0.30	0.50	0.012	0.020
θ	0°	8°	0°	8°

PACKAGE INFORMATION

TAPE AND REEL INFORMATION

REEL DIMENSIONS

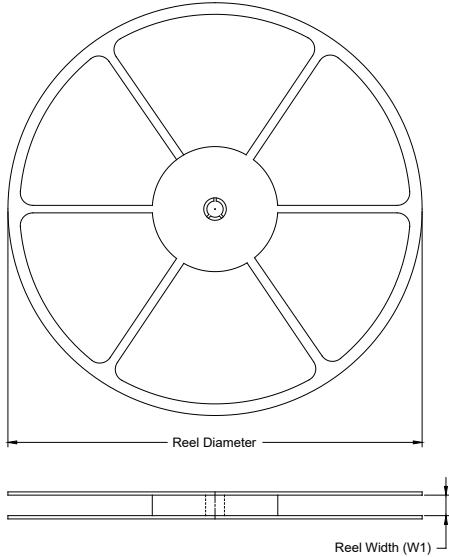

TAPE DIMENSIONS

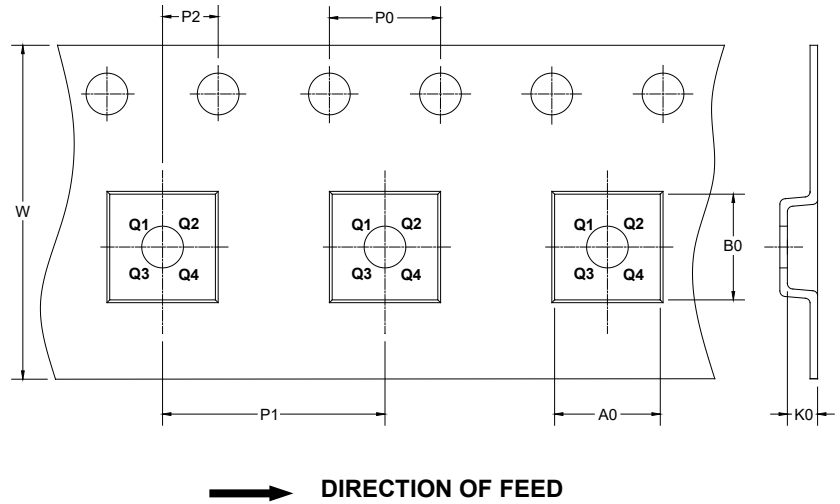

NOTE: The picture is only for reference. Please make the object as the standard.

KEY PARAMETER LIST OF TAPE AND REEL

Package Type	Reel Diameter	Reel Width W1 (mm)	A0 (mm)	B0 (mm)	K0 (mm)	P0 (mm)	P1 (mm)	P2 (mm)	W (mm)	Pin1 Quadrant
SC70-5	7"	9.5	2.25	2.55	1.20	4.0	4.0	2.0	8.0	Q3
SOT-23-5	7"	9.5	3.2	3.2	1.4	4.0	4.0	2.0	8.0	Q3
SOT-23-6	7"	9.5	3.17	3.23	1.37	4.0	4.0	2.0	8.0	Q3
SOIC-8	13"	12.4	6.4	5.4	2.1	4.0	8.0	2.0	12.0	Q1
MSOP-8	13"	12.4	5.2	3.3	1.5	4.0	8.0	2.0	12.0	Q1
TSSOP-8	13"	12.4	6.76	3.3	1.8	4.0	8.0	2.0	12.0	Q1
TSSOP-14	13"	12.4	6.95	5.6	1.2	4.0	8.0	2.0	12.0	Q1
SOIC-14	13"	16.4	6.6	9.3	2.1	4.0	8.0	2.0	16.0	Q1

D00001

PACKAGE INFORMATION

CARTON BOX DIMENSIONS



NOTE: The picture is only for reference. Please make the object as the standard.

KEY PARAMETER LIST OF CARTON BOX

Reel Type	Length (mm)	Width (mm)	Height (mm)	Pizza/Carton
7" (Option)	368	227	224	8
7"	442	410	224	18
13"	386	280	370	5

DD0002

单击下面可查看定价，库存，交付和生命周期等信息

[>>SGMICRO\(圣邦微电子\)](#)