

GENERAL DESCRIPTION

The SGM65231 is an 8-Bit, low voltage and high bandwidth bus switch. It supports rail-to-rail switching on data I/O ports and the power supply range is designed from 2.3V to 3.6V.

The SGM65231 has low on-resistance (R_{ON}) and low data I/O capacitance. These features make the device allow for minimal propagation delay and minimize signal distortion on the data bus.

It is recommended to connect a pull-up resistor between the \overline{OE} pin and V_{CC} pin to ensure high impedance during power-on or power-off. The ability of the driver to absorb current can determine the minimum value of the resistor.

The SGM65231 is designed with an I_{OFF} circuitry. When the device is powered down, the I_{OFF} circuitry can effectively prevent the destructive current backflow, and the SGM65231 has an isolation function in the state of power-off. This feature is widely used in partial-power-down applications.

The SGM65231 is suitable in a variety of applications such as high bandwidth equipment, broadband communications and data-intensive computing systems.

The SGM65231 is available in Green TQFN-4.5×3.5-20L and TSSOP-20 packages. It operates over an operating temperature range of -40°C to +125°C.

FEATURES

- **Operating Voltage Range (V_{CC}): 2.3V to 3.6V**
- **Data I/Os Support 0V to 5V Signaling Levels: 0.8V, 1.2V, 1.5V, 1.8V, 2.5V, 3.3V, 5V**
- **Rail-to-Rail Switching on Data I/O Ports**
 - 0V to 5V Signal Passing, $V_{CC} = 3.3V$
 - 0V to 3.3V Signal Passing, $V_{CC} = 2.5V$
- **High Bandwidth Data Path**
- **Low On-Resistance (R_{ON}): 4.5Ω (TYP)**
- **Low Power Consumption (I_{CC}): = 0.5mA (TYP)**
- **5V Tolerant I/Os with Device Powered Up or Powered Down**
- **Bidirectional Data Flow**
- **Low Input/Output Capacitance Minimizes Loading and Signal Distortion**
- **Data and Control Inputs Provide Undershoot Clamp Diodes**
- **Control Input Can Be Driven by TTL or 5V/3.3V CMOS Outputs**
- **Support Partial-Power-Down Mode Operation**
- **Available in Green TQFN-4.5×3.5-20L and TSSOP-20 Packages**

APPLICATIONS

Differential Signal Interface
PCI Interface
Low Distortion Signal Gating
Memory Interleaving, Bus Isolation

PACKAGE/ORDERING INFORMATION

MODEL	PACKAGE DESCRIPTION	SPECIFIED TEMPERATURE RANGE	ORDERING NUMBER	PACKAGE MARKING	PACKING OPTION
SGM65231	TQFN-4.5×3.5-20L	-40°C to +125°C	SGM65231XTQS20G/TR	SGM65231 XTQS20 XXXXX	Tape and Reel, 4000
	TSSOP-20	-40°C to +125°C	SGM65231XTS20G/TR	SGM65231XTS20 XXXXX	Tape and Reel, 4000

MARKING INFORMATION

NOTE: XXXXX = Date Code, Trace Code and Vendor Code.

XXXXX

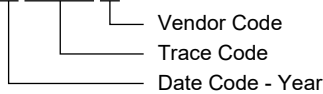

Green (RoHS & HSF): SG Micro Corp defines "Green" to mean Pb-Free (RoHS compatible) and free of halogen substances. If you have additional comments or questions, please contact your SGMICRO representative directly.

ABSOLUTE MAXIMUM RATINGS

Supply Voltage Range, V_{CC}	-0.3V to 4.6V
Control Input Voltage Range ⁽¹⁾ , V_{IN}	-0.3V to 7V
Switch I/O Voltage Range ⁽¹⁾⁽²⁾ , $V_{I/O}$	-0.3V to 7V
Junction Temperature	+150°C
Storage Temperature Range	-65°C to +150°C
Lead Temperature (Soldering, 10s)	+260°C
ESD Susceptibility	
HBM	7000V
CDM	1000V

RECOMMENDED OPERATING CONDITIONS

Supply Voltage Range, V_{CC}	2.3V to 3.6V
High-Level Control Input Voltage, V_{IH}	
$V_{CC} = 2.3V$ to 2.7V	1.7V to 5.5V
$V_{CC} = 2.7V$ to 3.6V	2V to 5.5V
Low-Level Control Input Voltage, V_{IL}	
$V_{CC} = 2.3V$ to 2.7V	0V to 0.7V
$V_{CC} = 2.7V$ to 3.6V	0V to 0.8V
Data Input/Output Voltage, $V_{I/O}$	0V to 5.5V
Operating Temperature Range	-40°C to +125°C

NOTES:

1. All voltages are respected to GND, unless otherwise noted.
2. V_I and V_O are respectively used to represent $V_{I/O}$ under specific conditions.

OVERSTRESS CAUTION

Stresses beyond those listed in Absolute Maximum Ratings may cause permanent damage to the device. Exposure to absolute maximum rating conditions for extended periods may affect reliability. Functional operation of the device at any conditions beyond those indicated in the Recommended Operating Conditions section is not implied.

ESD SENSITIVITY CAUTION

This integrated circuit can be damaged if ESD protections are not considered carefully. SGMICRO recommends that all integrated circuits be handled with appropriate precautions. Failure to observe proper handling and installation procedures can cause damage. ESD damage can range from subtle performance degradation to complete device failure. Precision integrated circuits may be more susceptible to damage because even small parametric changes could cause the device not to meet the published specifications.

DISCLAIMER

SG Micro Corp reserves the right to make any change in circuit design, or specifications without prior notice.

PIN CONFIGURATIONS

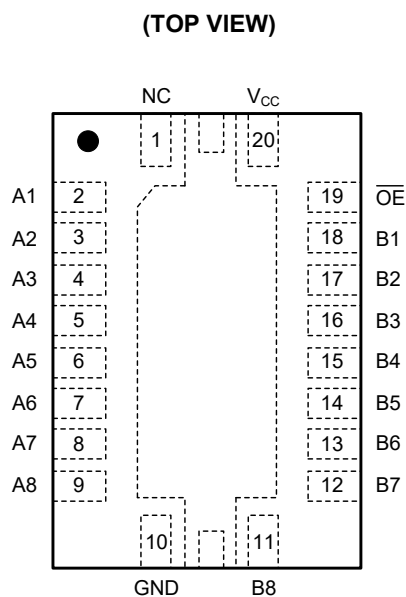

TQFN-4.5x3.5-20L

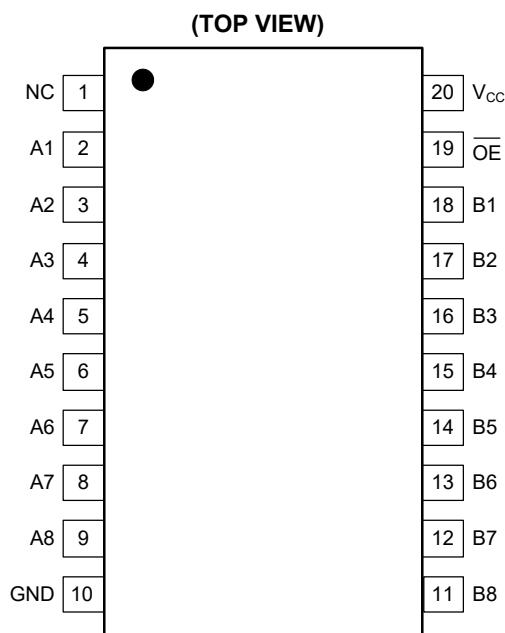

TSSOP-20

PIN DESCRIPTION

PIN	NAME	I/O	FUNCTION
TQFN-4.5x3.5-20L/TSSOP-20			
1	NC	—	No Internal Connection.
2	A1	I/O	Bidirectional Analog Input/Output A1.
3	A2	I/O	Bidirectional Analog Input/Output A2.
4	A3	I/O	Bidirectional Analog Input/Output A3.
5	A4	I/O	Bidirectional Analog Input/Output A4.
6	A5	I/O	Bidirectional Analog Input/Output A5.
7	A6	I/O	Bidirectional Analog Input/Output A6.
8	A7	I/O	Bidirectional Analog Input/Output A7.
9	A8	I/O	Bidirectional Analog Input/Output A8.
10	GND	—	Ground.
11	B8	I/O	Bidirectional Analog Input/Output B8.
12	B7	I/O	Bidirectional Analog Input/Output B7.
13	B6	I/O	Bidirectional Analog Input/Output B6.
14	B5	I/O	Bidirectional Analog Input/Output B5.
15	B4	I/O	Bidirectional Analog Input/Output B4.
16	B3	I/O	Bidirectional Analog Input/Output B3.
17	B2	I/O	Bidirectional Analog Input/Output B2.
18	B1	I/O	Bidirectional Analog Input/Output B1.
19	OE	I	Enable Control Input (Active Low).
20	V _{CC}	—	Positive Power Supply.

PACKAGE OUTLINE DIMENSIONS

TQFN-4.5x3.5-20L

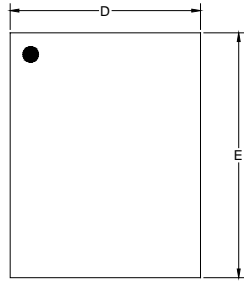

TOP VIEW

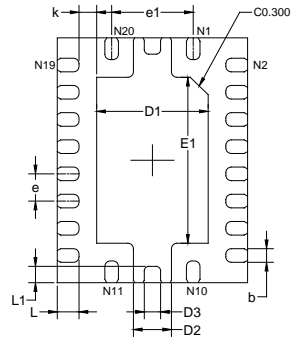

BOTTOM VIEW

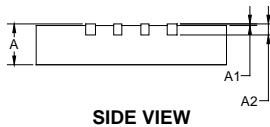

SIDE VIEW

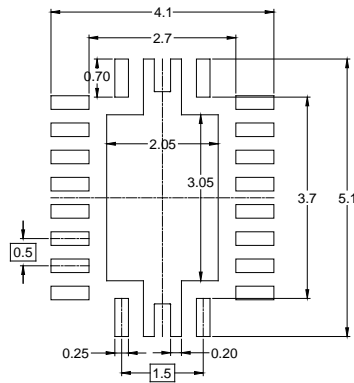

RECOMMENDED LAND PATTERN (Unit: mm)

Symbol	Dimensions In Millimeters		Dimensions In Inches	
	MIN	MAX	MIN	MAX
A	0.700	0.800	0.028	0.031
A1	0.000	0.050	0.000	0.002
A2	0.203 REF		0.008 REF	
D	3.400	3.600	0.134	0.142
D1	1.950	2.150	0.077	0.085
D2	0.650	0.850	0.026	0.033
D3	0.250	0.450	0.010	0.018
E	4.400	4.600	0.173	0.181
E1	2.950	3.150	0.116	0.124
k	0.325 REF		0.013 REF	
b	0.200	0.300	0.008	0.012
L	0.300	0.500	0.012	0.020
L1	0.224	0.376	0.009	0.015
e	0.500 BSC		0.020 BSC	
e1	1.500 BSC		0.060 BSC	

PACKAGE OUTLINE DIMENSIONS

TSSOP-20

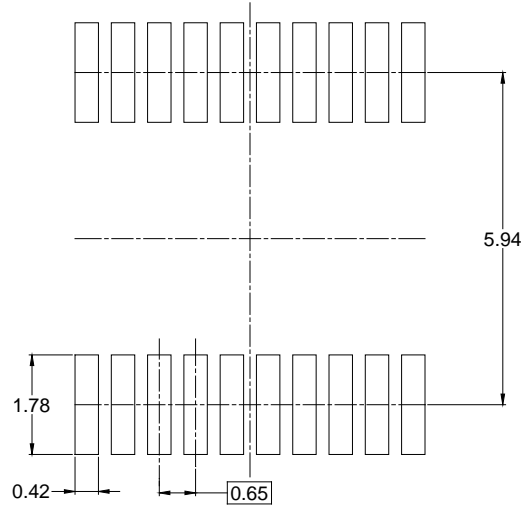
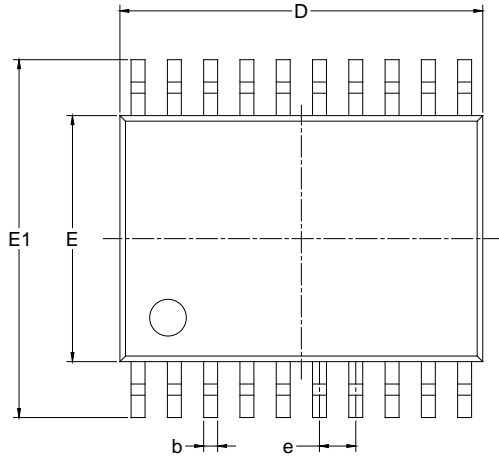

RECOMMENDED LAND PATTERN (Unit: mm)

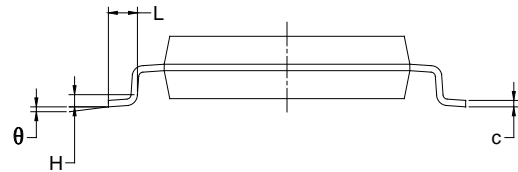
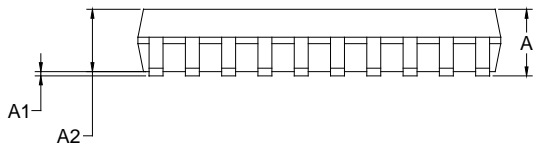

Symbol	Dimensions In Millimeters		
	MIN	MOD	MAX
A		-	1.200
A1	0.050	-	0.150
A2	0.800	-	1.050
b	0.190	-	0.300
c	0.090	-	0.200
D	6.400	-	6.600
E	4.300	-	4.500
E1	6.250	-	6.550
e	0.650 BSC		
L	0.450	-	0.750
H	0.250 TYP		
θ	0°	-	8°

NOTES:

1. Body dimensions do not include mode flash or protrusion.
2. This drawing is subject to change without notice.

TAPE AND REEL INFORMATION

REEL DIMENSIONS



TAPE DIMENSIONS

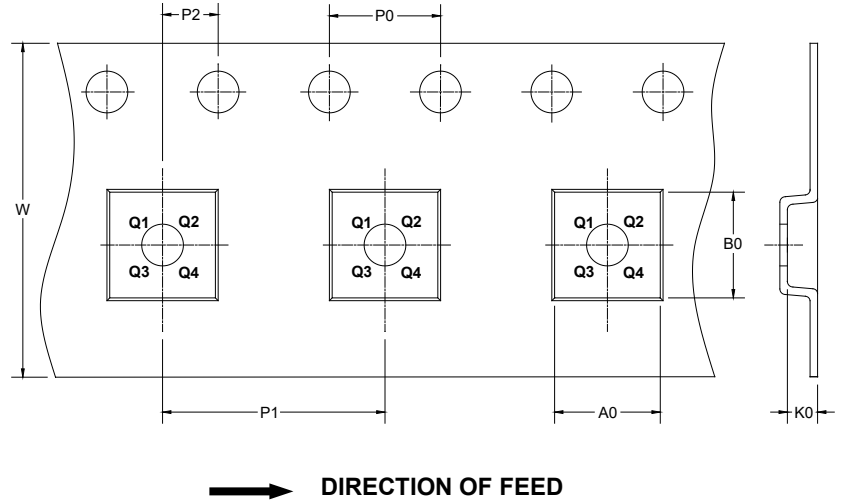

NOTE: The picture is only for reference. Please make the object as the standard.

KEY PARAMETER LIST OF TAPE AND REEL

Package Type	Reel Diameter	Reel Width W1 (mm)	A0 (mm)	B0 (mm)	K0 (mm)	P0 (mm)	P1 (mm)	P2 (mm)	W (mm)	Pin1 Quadrant
TQFN-4.5×3.5-20L	13"	12.4	3.75	4.75	0.95	4.0	8.0	2.0	12.0	Q1
TSSOP-20	13"	16.4	6.90	7.00	1.50	4.0	8.0	2.0	16.0	Q1

DD0001

PACKAGE INFORMATION

CARTON BOX DIMENSIONS



NOTE: The picture is only for reference. Please make the object as the standard.

KEY PARAMETER LIST OF CARTON BOX

Reel Type	Length (mm)	Width (mm)	Height (mm)	Pizza/Carton
13"	386	280	370	5

DD0002

单击下面可查看定价，库存，交付和生命周期等信息

[>>SGMICRO\(圣邦微电子\)](#)