

GENERAL DESCRIPTION

The SGM40561 is a low cost battery charger with integrated high input voltage capability for single-cell Li-Ion or Li-polymer batteries. The SGM40561 has a CC/CV charge profile required for Li-Ion battery. The SGM40561 features the over-voltage protection (OVP) function. The OVP threshold is typically 10.5V. The SGM40561 accepts a 26.5V maximum voltage for power input, when $V_{IN} > V_{OVP}$, the charger is disabled.

The SGM40561 has a charge indication feature. When the charger is disabled or the input is floating, the leakage current from the battery is $< 1\mu\text{A}$.

The SGM40561 is available in a Green TDFN-2x2-8L package and is rated over the -40°C to $+85^{\circ}\text{C}$ temperature range.

FEATURES

- **Charge Voltages: 4.2V/4.3V/4.35V**
- **5mA to 200mA Charger for Tiny Cell Li-Ion or Polymer Batteries**
- **Trickle Charge Thresholds: 2.55V/2.62V/2.65V**
- **Input Over-Voltage Protection Threshold: 10.5V**
- **Power Input Voltage up to 26.5V**
- **Less Components and Low Cost**
- **Selectable Charge Current**
- **Selectable Full-of-Charge Current**
- **Thermal Regulation Function**
- **Charging Status Indication**
- **1 μA (MAX) Leakage Current when Charger Disabled or Input Floating**
- **Available in a Green TDFN-2x2-8L Package**

APPLICATIONS

IOT Gadgets
Credential Keys
Wireless Remote
Portable Internet Devices and Accessory

PACKAGE/ORDERING INFORMATION

MODEL	V _{CH} (V)	PACKAGE DESCRIPTION	SPECIFIED TEMPERATURE RANGE	ORDERING NUMBER	PACKAGE MARKING	PACKING OPTION
SGM40561	4.2	TDFN-2×2-8L	-40°C to +85°C	SGM40561-4.2YTDE8G/TR	SZD XXXX	Tape and Reel, 3000
	4.3	TDFN-2×2-8L	-40°C to +85°C	SGM40561-4.3YTDE8G/TR	SX7 XXXX	Tape and Reel, 3000
	4.35	TDFN-2×2-8L	-40°C to +85°C	SGM40561-4.35YTDE8G/TR	SX4 XXXX	Tape and Reel, 3000

MARKING INFORMATION

NOTE: XXXX = Date Code.

YYY — Serial Number

XXXX

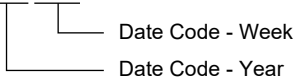

Green (RoHS & HSF): SG Micro Corp defines "Green" to mean Pb-Free (RoHS compatible) and free of halogen substances. If you have additional comments or questions, please contact your SGMICRO representative directly.

ABSOLUTE MAXIMUM RATINGS

Voltage Range (with Respect to GND)

- V_{IN} -0.3V to 30V
- PPR, CHG, EN, I_{MIN}, I_{REF}, BAT -0.3V to 6V
- Package Thermal Resistance
- TDFN-2×2-8L, θ_{JA} 118°C/W
- Junction Temperature +150°C
- Storage Temperature Range -65°C to +150°C
- Lead Temperature (Soldering, 10s) +260°C
- ESD Susceptibility
- HBM 4000V
- MM 200V
- CDM 1000V

RECOMMENDED OPERATING CONDITIONS

- Supply Voltage Range 4.55V to 9.35V
- Maximum Supply Voltage 26.5V
- Programmed Charge Current 5mA to 200mA
- Operating Temperature Range -40°C to +85°C

OVERSTRESS CAUTION

Stresses beyond those listed in Absolute Maximum Ratings may cause permanent damage to the device. Exposure to absolute maximum rating conditions for extended periods may affect reliability. Functional operation of the device at any conditions beyond those indicated in the Recommended Operating Conditions section is not implied.

ESD SENSITIVITY CAUTION

This integrated circuit can be damaged by ESD if you don't pay attention to ESD protection. SGMICRO recommends that all integrated circuits be handled with appropriate precautions. Failure to observe proper handling and installation procedures can cause damage. ESD damage can range from subtle performance degradation to complete device failure. Precision integrated circuits may be more susceptible to damage because very small parametric changes could cause the device not to meet its published specifications.

DISCLAIMER

SG Micro Corp reserves the right to make any change in circuit design, or specifications without prior notice.

PIN CONFIGURATION

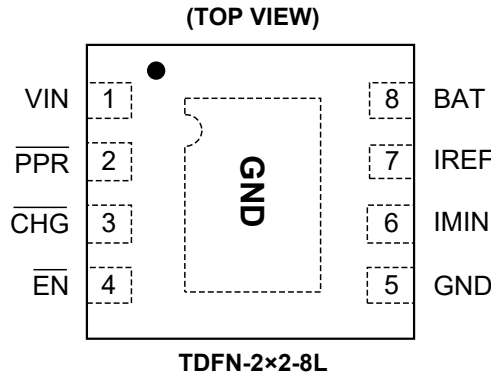

PIN DESCRIPTION

PIN	NAME	FUNCTION
1	VIN	Power Input Pin. It is recommended to use a 1μF (or larger value) X5R ceramic capacitor from VIN pin to ground to get good power supply decoupling. This ceramic capacitor should be placed as close as possible to VIN pin.
2	PPR	Open-Drain Power Presence Indication Pin. A low state indicates a good input voltage range ($V_{POR} < VIN < V_{OVP}$), and is independent on the EN pin.
3	CHG	Open-Drain Charge Indication Pin. A low state indicates a charging state.
4	EN	Enable Input Pin. Active low. The pin is used to enable or disable the charger, and it has an internal 200kΩ pull-down resistor. When it goes high, the charger is disabled. When it goes low or left floating, the charger is enabled.
5	GND	Ground.
6	IMIN	Full-of-Charge Current Selectable Pin. The FOC current is set by connecting a resistor between this pin and GND. The calculation formula of the FOC current I_{MIN} is as follows: $I_{MIN} = \frac{10980}{R_{IMIN}} + 0.15 \text{ (mA)}$ where, R_{IMIN} is in kΩ.
7	IREF	Charge-Current Selectable Pin. Connect a resistor between IREF and GND pins to set the charge current limit according to the following formula: $I_{REF} = \frac{12033}{R_{IREF}} + 0.4 \text{ (mA)}$ where, R_{IREF} is in kΩ. The resistor should be placed as close to this pin as possible. When disabled, $V_{IREF} = 0V$.
8	BAT	Battery Positive Terminal Pin. It is recommended to connect a 1μF (or larger value) X5R ceramic capacitor. When the EN pin goes to high, the BAT output is disabled.
Exposed Pad	GND	Exposed Pad. Thermal pad is internally grounded and must be connected to the PCB GND plane.

ELECTRICAL CHARACTERISTICS

(V_{IN} = 5V, R_{IMIN} = 3MΩ, T_A = +25°C, unless otherwise noted.)

PARAMETER	SYMBOL	CONDITIONS	MIN	TYP	MAX	UNITS	
Power-On Reset							
Rising POR Threshold	V _{POR}	V _{BAT} = 3.0V, R _{IREF} = 602kΩ, use $\overline{\text{PPR}}$ to indicate the comparator output	3.21	3.95	4.55	V	
Falling POR Threshold			2.86	3.60	4.35	V	
VIN-BAT Offset Voltage							
Rising Edge	V _{OS}	V _{BAT} forced to 4.5V, R _{IREF} = 602kΩ, use $\overline{\text{PPR}}$ pin to indicate the comparator output ⁽¹⁾		110	200	mV	
Falling Edge			5	60		mV	
Over-Voltage Protection							
Over-Voltage Protection Threshold	V _{OVP}	V _{BAT} forced to 4.4V, R _{IREF} = 602kΩ, use $\overline{\text{PPR}}$ to indicate the comparator output	9.35	10.50	11.15	V	
	V _{OVPHYS}		245	340	430	mV	
Standby Current							
BAT Pin Sink Current	I _{STANDBY}	Input floating		0.1	0.6	μA	
		Charger disabled		0.2	1		
VIN Pin Supply Current	I _{VIN}	V _{BAT} forced to 4.4V, R _{IREF} = 301kΩ	charger disabled	180	250	μA	
			charger enabled	250	320		
Voltage Regulation							
Output Voltage	SGM40561-4.2	V _{CH}	R _{IREF} = 301kΩ, V _{IN} = 5V, charge current = 3mA	4.152	4.2	4.248	V
	SGM40561-4.3			4.252	4.3	4.348	
	SGM40561-4.35			4.302	4.35	4.398	
Charge Current ⁽²⁾							
IREF Pin Output Voltage	V _{IREF}	V _{BAT} = 3.8V, R _{IREF} = 602kΩ	1.162	1.21	1.262	V	
Constant Charge Current	I _{REF}	R _{IREF} = 301kΩ, V _{BAT} = 3.8V	34	40	46	mA	
Trickle Charge Current	I _{TRK}	R _{IREF} = 301kΩ, V _{BAT} = 2.4V	3.5	7.5	11.5	mA	
Full-of-Charge Current	I _{MIN}	R _{IREF} = 301kΩ	1	4	7	mA	
FOC Rising Threshold		R _{IREF} = 301kΩ	22	31	40	mA	
Pre-conditioning Charge Threshold							
Pre-conditioning Charge Threshold Voltage	SGM40561-4.2	V _{MIN}	R _{IREF} = 60.4kΩ		2.55		V
	SGM40561-4.3				2.62		
	SGM40561-4.35				2.65		
Pre-conditioning Voltage Hysteresis	V _{MINHYS}	R _{IREF} = 60.4kΩ		100		mV	
Internal Temperature Monitoring							
Thermal Regulation Threshold	T _{REG}			115		°C	

NOTES:

- By selecting 4.5V V_{BAT}, the $\overline{\text{PPR}}$ output can be used as the indication for the offset comparator output indication. If the V_{BAT} is below the POR threshold, no output pins are available to indicate.
- The charge current may be affected by the thermal regulation function.

ELECTRICAL CHARACTERISTICS (continued)(V_{IN} = 5V, R_{MIN} = 3MΩ, T_A = +25°C, unless otherwise noted.)

PARAMETER	SYMBOL	CONDITIONS	MIN	TYP	MAX	UNITS
Logic Input and Outputs						
$\overline{\text{EN}}$ Pin Logic Input High			1.6			V
$\overline{\text{EN}}$ Pin Logic Input Low					0.8	V
$\overline{\text{EN}}$ Pin Internal Pull-Down Resistance			150	200	250	kΩ
$\overline{\text{CHG}}$ Pin On-Resistance when LOW		Pin voltage = 1V		42	67	Ω
$\overline{\text{CHG}}$ Leakage Current when High Impedance		V _{$\overline{\text{CHG}}$} = 5.5V			4.5	μA
$\overline{\text{PPR}}$ Pin On-Resistance when LOW		Pin voltage = 1V		42	67	Ω
$\overline{\text{PPR}}$ Leakage Current when High Impedance		V _{$\overline{\text{PPR}}$} = 5.5V			4.5	μA

TYPICAL PERFORMANCE CHARACTERISTICS

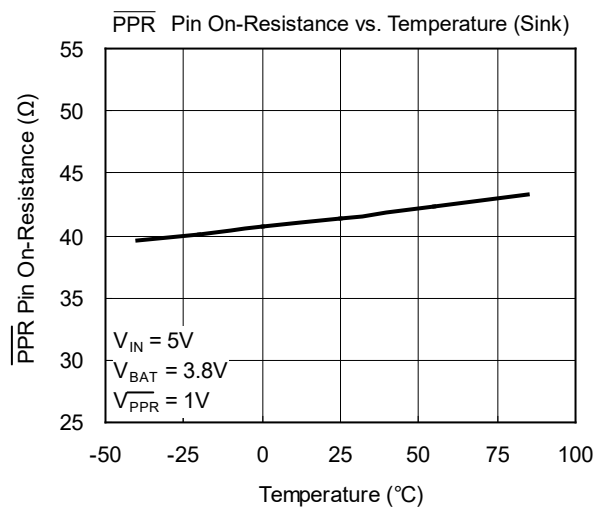
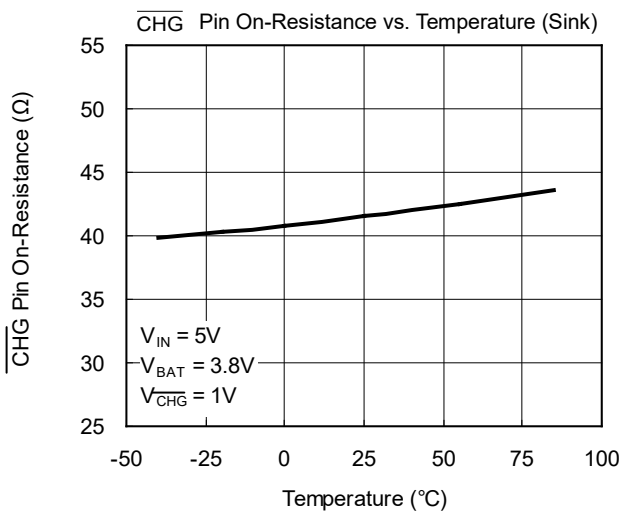
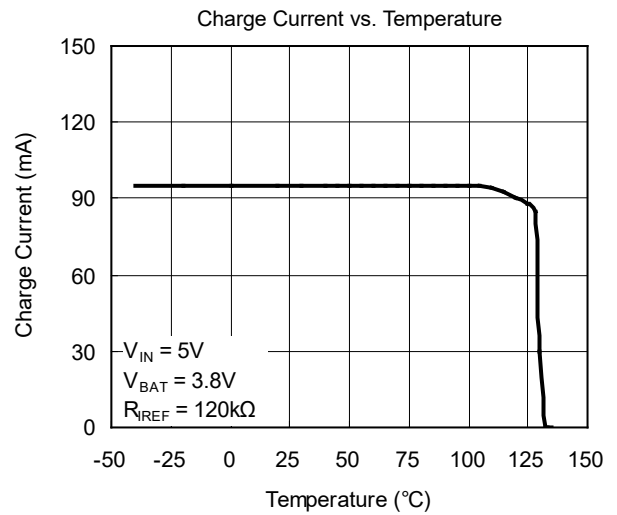
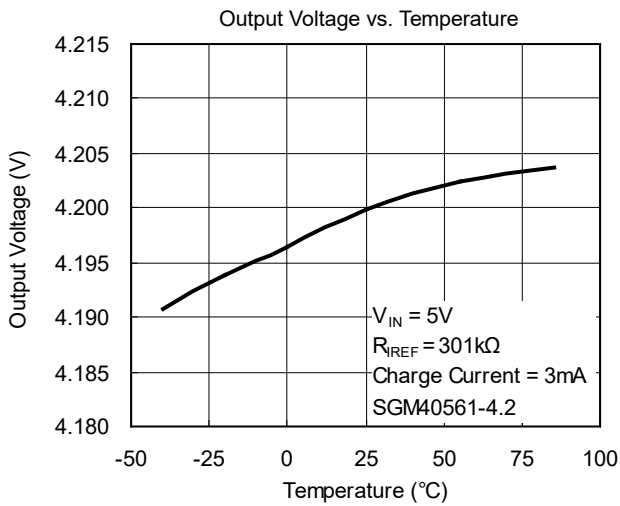
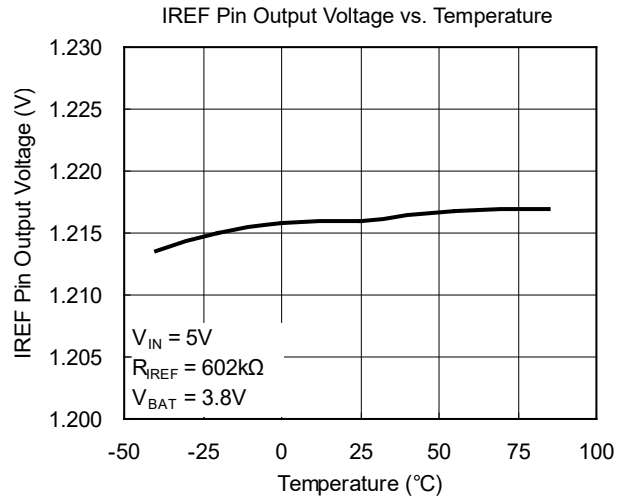
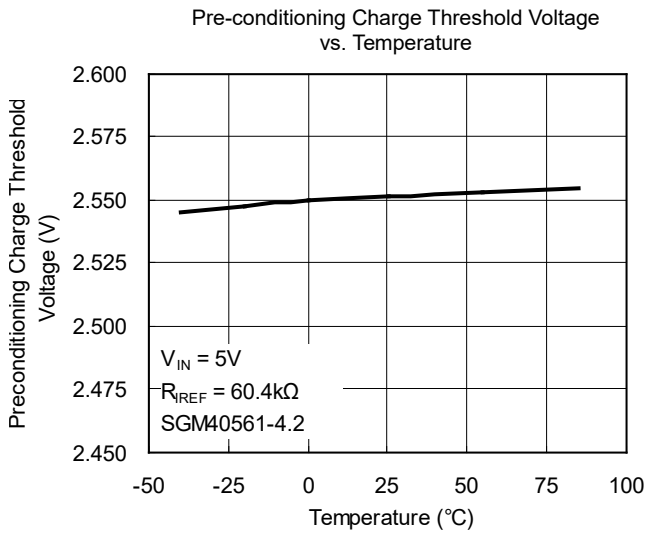

TYPICAL PERFORMANCE CHARACTERISTICS (continued)

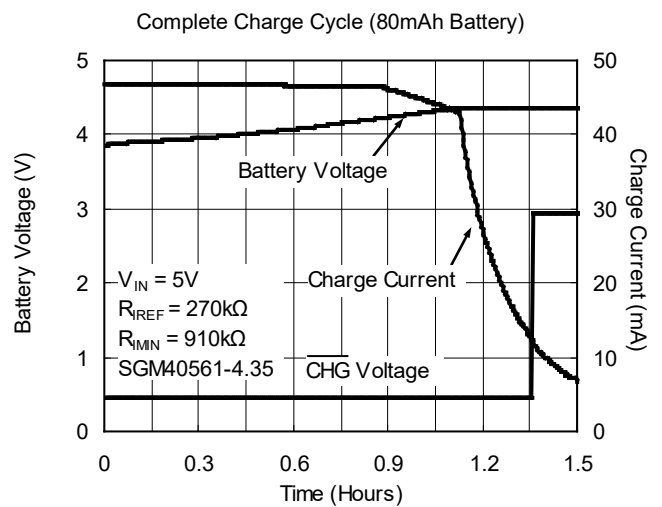
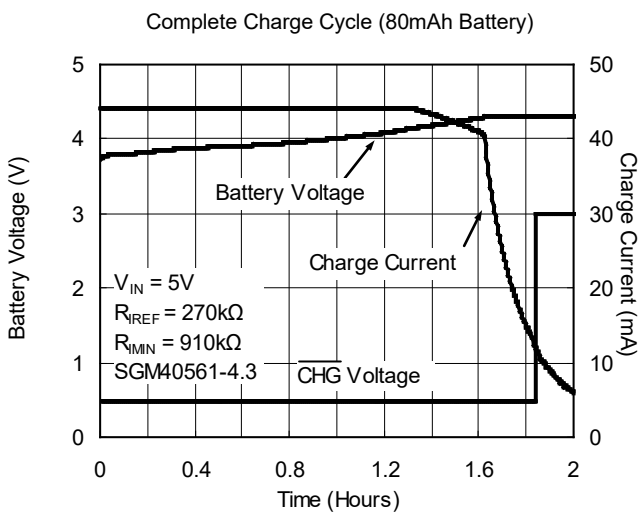
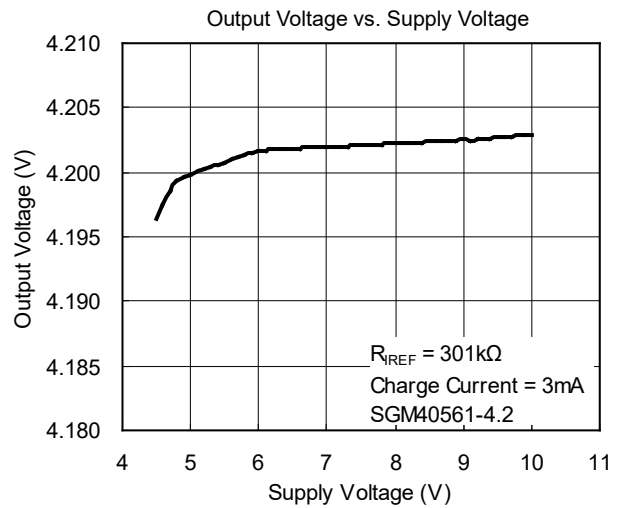
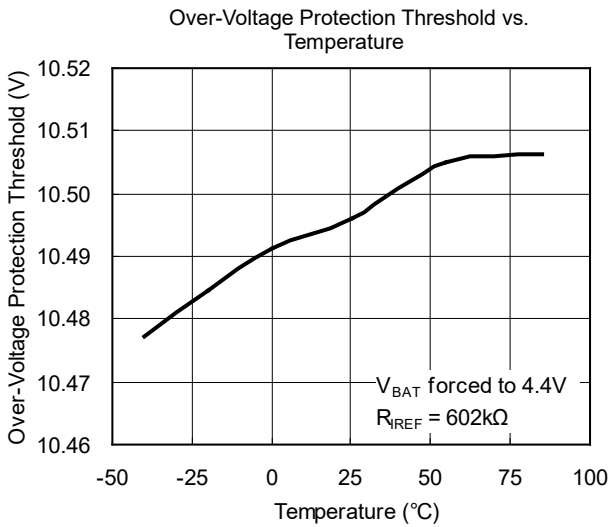
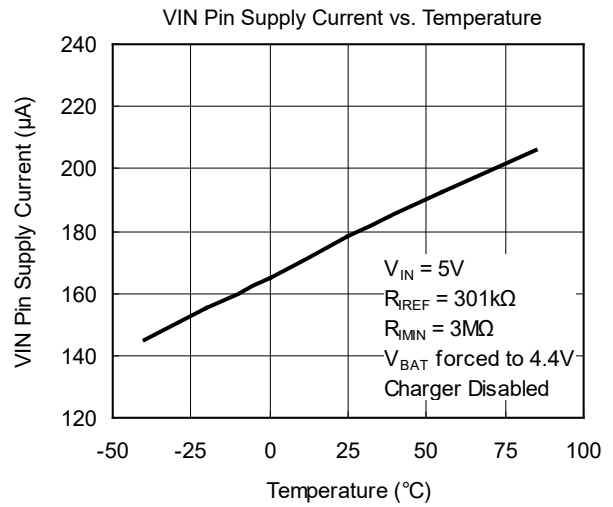
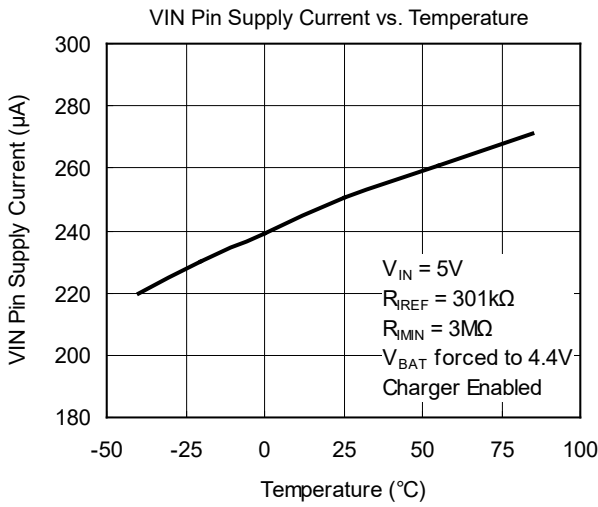

TYPICAL PERFORMANCE CHARACTERISTICS (continued)

Charge Current Selectable 2σ Tolerance Guide

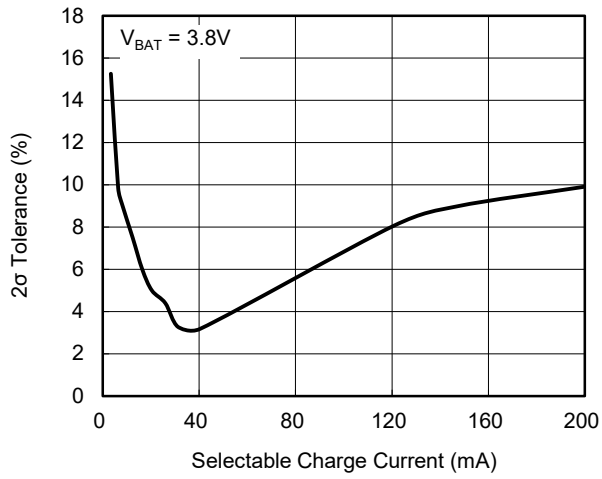

Full-of-Charge Current Selectable 2σ Tolerance Guide

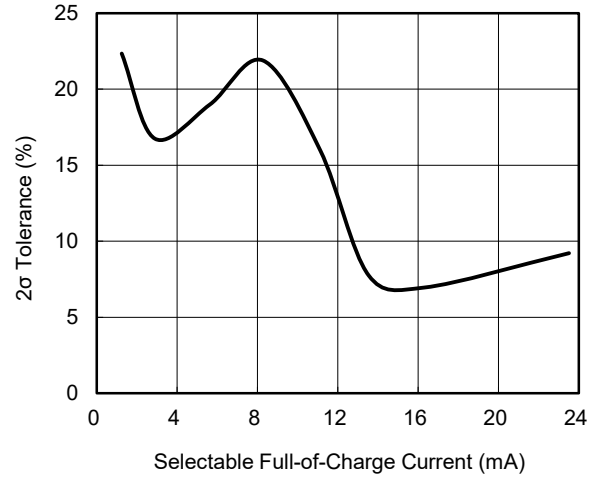

TYPICAL APPLICATION CIRCUITS

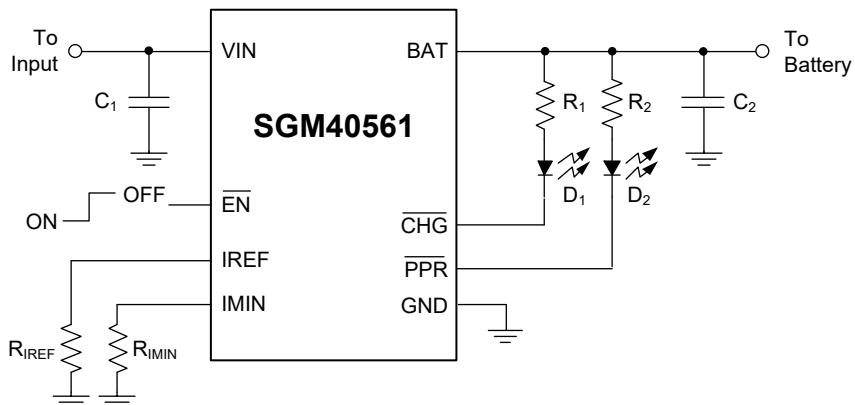

Figure 1. Typical Application Circuit Interfacing to Indication LEDs

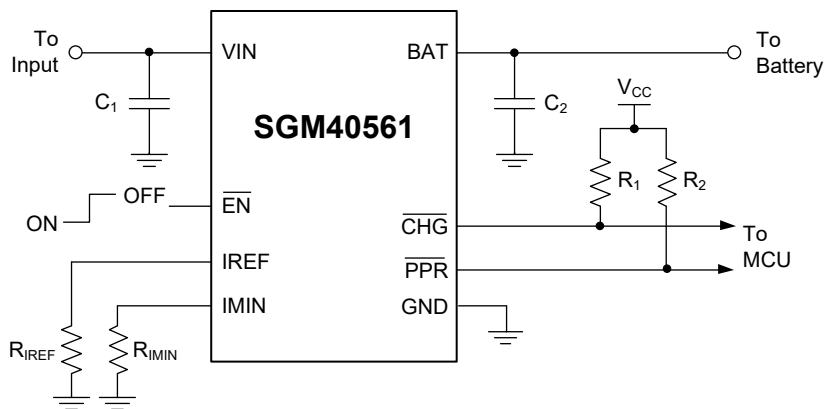

Figure 2. Typical Application Circuit with the Indication Signals Interfacing to an MCU

Table 1. Component Description for Typical Application Circuits

Component	Description
C ₁	1μF X5R ceramic cap.
C ₂	1μF X5R ceramic cap.
R _{IREF}	301kΩ, for 40mA charge current
R _{IMIN}	3MΩ, for 4mA FOC current
D ₁ , D ₂	LEDs for indication, for Figure 1
R ₁ , R ₂	100kΩ, 5%, for Figure 2

TYPICAL APPLICATION CIRCUITS (continued)

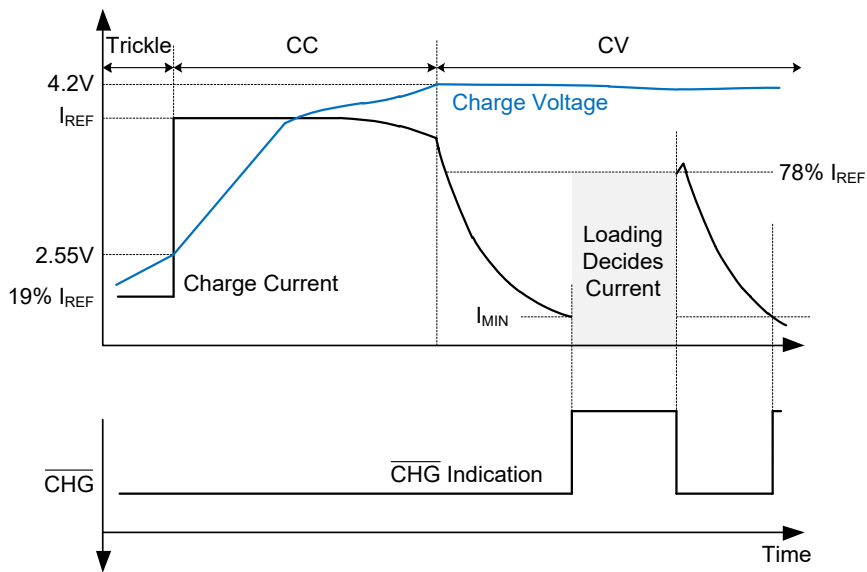

Figure 3. Typical Charge Profile (SGM40561-4.2)

REVISION HISTORY

NOTE: Page numbers for previous revisions may differ from page numbers in the current version.

SEPTEMBER 2022 – REV.A.4 to REV.B

Update General Description section	1
Update Typical Application Circuits section.....	9, 10

AUGUST 2018 – REV.A.3 to REV.A.4

Updated Pin Description section	3
Updated Typical Performance Characteristics section	8

OCTOBER 2017 – REV.A.2 to REV.A.3

Changed Electrical Characteristics section	5
--	---

APRIL 2017 – REV.A.1 to REV.A.2

Changed Absolute Maximum Ratings section.....	2
---	---

OCTOBER 2016 – REV.A to REV.A.1

Changed Electrical Characteristics section	4
--	---

Changes from Original (SEPTEMBER 2015) to REV.A

Changed from product preview to production data.....	All
--	-----

PACKAGE OUTLINE DIMENSIONS

TDFN-2x2-8L

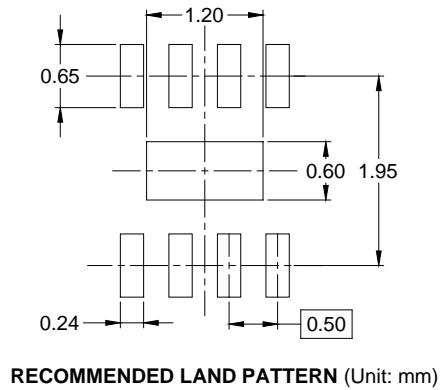
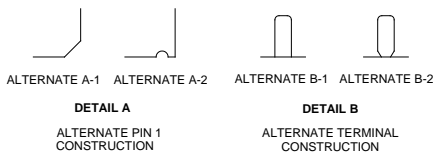
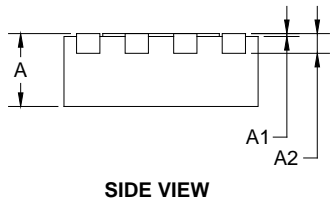
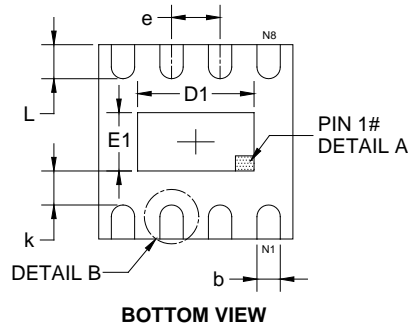
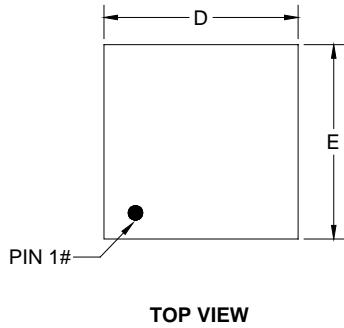

Symbol	Dimensions In Millimeters		
	MIN	MOD	MAX
A	0.700	0.750	0.800
A1	0.000	-	0.050
A2	0.203 REF		
D	1.900	2.000	2.100
E	1.900	2.000	2.100
D1	1.100	1.200	1.300
E1	0.500	0.600	0.700
b	0.180	-	0.300
e	0.500 TYP		
k	0.200 MIN		
L	0.250	0.350	0.450

NOTE: This drawing is subject to change without notice.

PACKAGE INFORMATION

TAPE AND REEL INFORMATION

REEL DIMENSIONS



TAPE DIMENSIONS



NOTE: The picture is only for reference. Please make the object as the standard.

KEY PARAMETER LIST OF TAPE AND REEL

Package Type	Reel Diameter	Reel Width W1 (mm)	A0 (mm)	B0 (mm)	K0 (mm)	P0 (mm)	P1 (mm)	P2 (mm)	W (mm)	Pin1 Quadrant
TDFN-2×2-8L	7"	9.5	2.30	2.30	1.10	4.0	4.0	2.0	8.0	Q1

000001

PACKAGE INFORMATION

CARTON BOX DIMENSIONS



NOTE: The picture is only for reference. Please make the object as the standard.

KEY PARAMETER LIST OF CARTON BOX

Reel Type	Length (mm)	Width (mm)	Height (mm)	Pizza/Carton
7" (Option)	368	227	224	8
7"	442	410	224	18

DD0002

单击下面可查看定价，库存，交付和生命周期等信息

[>>SGMICRO\(圣邦微电子\)](#)